

## Operating Instructions

### Controller

**B130/B150/B180/C280/P300/P310/P330**

-> 06.2011 (V 4.04)

Original instructions

- Made
- in
- Germany

---

**Copyright**

© Copyright by  
Nabertherm GmbH  
Bahnhofstrasse 20  
28865 Lilienthal  
Federal Republic of Germany

Reg: M03.0001 ENGLISCH  
Rev: 2012-07

No responsibility is accepted for the correctness of this information. We reserve the right to make technical alterations.

<b>1</b>	<b>Introduction .....</b>	<b>6</b>
1.1	Warranty and Liability .....	7
1.2	General .....	8
1.3	Safety .....	8
<b>2</b>	<b>Operation .....</b>	<b>9</b>
2.1	Power Switch/Control Current Switch .....	9
2.2	Turning on the Controller/Furnace .....	9
2.3	Turning off the Controller/Furnace .....	9
<b>3</b>	<b>Control Fields and Display .....</b>	<b>10</b>
3.1	Display .....	12
3.2	Keyboard Blocks .....	12
<b>4</b>	<b>Features of the Controller .....</b>	<b>15</b>
4.1	Functions .....	15
<b>5</b>	<b>New Functions of the Nabertherm Controller .....</b>	<b>16</b>
5.1	Program Entry with/without Gradient as of Version 3.xx .....	16
5.2	Program Starting Behavior for warm Furnaces as of Controller Version 3.xx .....	16
5.3	Power Failure Behavior .....	16
<b>6</b>	<b>Controller B 130/C 280 .....</b>	<b>17</b>
6.1	Operating Instructions Summary .....	17
6.2	Setting or changing Program/Waiting Time .....	18
6.3	Setting or Changing the Waiting Time .....	19
6.4	Programming Extra Functions .....	20
6.5	Programming Extra Functions in "T3" (C 280 only) .....	20
6.6	Turning Extra Functions in Program Execution on and off by Hand .....	21
6.7	Saving Programs .....	21
6.8	Preconfigured Programs for the B 130/C 280 .....	22
6.9	Calling Programs .....	22
6.10	Program Start .....	23
6.11	Program Change During Execution .....	23
6.12	Terminating a Program .....	24
6.13	Key Locking .....	24
6.14	Info Menu .....	25
<b>7</b>	<b>Controller B 150/B 180/P 300/P 310/P 330 .....</b>	<b>26</b>
7.1	Operating Instructions Summary B 150 .....	26
7.2	Operating Instructions Summary B 180/P 300/P 310/P 330 .....	27
7.3	Setting and Displaying the Date/Time on the P 330 .....	28
7.4	Setting or Changing Programs .....	28
7.5	Setting or Changing the Waiting Time .....	31
7.6	Setting or changing the Start Time .....	31
7.7	Programming Extra Functions .....	32
7.8	Turning Extra Functions in Program Execution on and off by Hand .....	33
7.9	Saving Programs .....	33
7.10	Calling Programs .....	34
7.11	Program Start .....	34

7.12	Changing Programs during Operation.....	34
7.13	Brief Program Interruption on the P 330.....	35
7.14	Terminating a Program.....	35
7.15	Segment Skip Key (P 300/P 310/P 330 only).....	35
7.16	Heating Circuits Key (P 310 only).....	36
7.17	Info Menu.....	37
<b>8</b>	<b>Power Failure Behavior for Version 3.xx Controllers and higher.....</b>	<b>38</b>
<b>9</b>	<b>Power Failure Behavior for Controller Versions 1-2.xx, built through the beginning of 2007.....</b>	<b>38</b>
9.1	Power Failure Behavior in the different Segments of B 130, C 280.....	38
9.2	Power Failure Behavior in the Different Segments of B 180, P 330.....	38
9.3	Power Failure Behavior for the B 150.....	38
9.4	Power Failure Behavior of P 300/P 310.....	38
<b>10</b>	<b>Eurotherm 2132i Over-Temperature Limit Controller for Installing in Controllers B 180 and P 330 (optional).....</b>	<b>39</b>
10.1	Eurotherm 2132i Over-Temperature Limit Controller.....	39
<b>11</b>	<b>Configuration/Customer-Specific Settings.....</b>	<b>40</b>
11.1	Configuration.....	40
11.2	Opening the Configuration on the B 130/B 150.....	40
11.3	Opening the Configuration for B 180/P 300/P 310/P 330.....	40
11.4	Configuration Options in Configuration Level 1 (Password = "0").....	40
11.4.1	Converting °C/°F.....	40
11.4.2	Settings for kW/h Counter.....	41
11.4.3	Setting the Interface Address.....	41
11.4.4	Program Entry with/without Gradient (as of Version 3.xx).....	41
11.4.5	Setting/Control of Power Failure Behavior (Version 3.xx or later).....	41
11.5	Configuration Options in Configuration Level 2 (Password = "2").....	42
11.6	Auto Tune.....	42
<b>12</b>	<b>Data Interface.....</b>	<b>43</b>
12.1	RS-422 Data Interface (optional).....	43
<b>13</b>	<b>Faults.....</b>	<b>44</b>
13.1	Fault Messages.....	44
<b>14</b>	<b>Fault Diagnosis.....</b>	<b>45</b>
14.1	Controller Check List.....	46
<b>15</b>	<b>Replacement Parts.....</b>	<b>48</b>
15.1	Replacing a Built-in Controller.....	48
<b>16</b>	<b>Specifications.....</b>	<b>49</b>
<b>17</b>	<b>Electrical Connections (Circuit Diagram).....</b>	<b>50</b>
17.1	Furnaces up to 3.6 kW – B 130, B 150, B 180, C 280, P 330 through 12/2008.....	50
17.2	Furnaces up to 3.6 kW – B 130, B 150, B 180, C 280, P 330 as of 01/2009.....	50
17.3	Furnaces > 3.6 kW with Semiconductor Relay – B 130, B 150, C 280, P 300.....	51
17.4	Furnaces > 3.6 kW with Heat Fuse – B 130, B 150, C 280, P 300.....	51
17.5	Furnaces > 3.6 kW with 2 Heating Circuits – P 310.....	52
17.6	Replacement Controller for Models C/S 3; C/S 5; C/S 7; C/S 8; C/S 19; C/S 30.....	52
17.6.1	Replacement for S 3 – S 30 Controllers through 12/2008.....	52

17.6.2 Replacement for S 3 – S 30 Controllers as of 01/2009..... 53

17.6.3 Replacement for C 3 – C 30 Controller ..... 53

18 Nabertherm Service ..... 54

19 For Your Notes ..... 55

## 1 Introduction

**Dear Customer,**

Thank you for choosing a quality product from Nabertherm GmbH.

With this system, you have selected a product which is tailored specifically to your manufacturing and production conditions and of which you can be justifiably proud.

This product is characterized by

- Easy operation
- LCD display
- Rugged construction
- For use near machinery
- Optional RS-422 data interface

Your Nabertherm Team



▶ **Note**

These documents are intended only for buyers of our products and may not be copied or disclosed to third parties without our written consent.

(Law governing copyright and associated protective rights, German Copyright Law from Sept. 9, 1965)

**Protective Rights**

Nabertherm GmbH owns all rights to drawings, other documents and authorizations, also in case of applications for protective rights.



Conforms to ANSI/UL STD 61010-1

C US Certified to CAN/CSA C22.2 No. 61010-1

**Intertek**  
3076970

## 1.1 Warranty and Liability



**As regards warranty and liability, the normal Nabertherm warranty terms apply, unless individual terms and conditions have been agreed. However, the following conditions also apply:**

Warranty and liability claims for personal injury or damage to property shall be excluded if they are attributable to one or more of the following causes:

- Everyone involved in operation, installation, maintenance, or repair of the furnace must have read and understood the operating instructions. No liability will be accepted for damage or disruptions to operation resulting from non-compliance with the operating instructions.
- Not using the furnace as intended,
- Improper installation, start-up, operation, or maintenance of the furnace,
- Operation of the furnace with defective safety equipment or improperly installed or non-functioning safety and protective equipment,
- Not observing the references in the operating instructions to transportation, storage, installation, start-up, operation, maintenance, or equipping the furnace,
- Making unauthorized changes to the furnace,
- Making unauthorized changes to the operating parameters,
- Making unauthorized changes to the parameterization, the settings, or the program,
- Original parts and accessories are designed especially for Nabertherm furnaces. Replace parts only with original Nabertherm parts. Otherwise the warranty will be void. Nabertherm accepts absolutely no liability for damage caused by using parts that are not original Nabertherm parts.
- Catastrophes due to third-party causes and force majeure.

---

## 1.2 General

Before working on electrical systems, switch the power switch to "0" and disconnect the power cord.

Even with the power switch off, some parts in the furnace may carry voltage.

Work on the electrical system may only be done by a trained person.

The furnace and switching system have been preset by Nabertherm. If required, process-specific optimization must be carried out in order to achieve the best possible control behavior.

The temperature curve must be modified by the user so that the load, furnace or surroundings are not damaged. Nabertherm GmbH assumes no guarantee for the process.



### Caution

Before working on the program-controlled grounding receptacle, the connector (optional series L, HTC, N, LH), or the connected device, always turn off the furnace and disconnect the power cord.

Read the operating instructions for the controller carefully to avoid mistakes or malfunctions in the operation of the controller or the furnace.

## 1.3 Safety

The controller has a series of electronic safety systems. If a fault occurs, the furnace automatically shuts off and a fault message appears in the LCD display.



### Note

For more information, please see Chapter "Faults - fault messages"



### Warning! General Hazards!

The Operating Instructions must be followed prior to switching on the furnace.



## 2 Operation

### 2.1 Power Switch/Control Current Switch



The power switch/control current switch is located below or next to the keyboard block. Stop running heating programs before turning off the furnace with the power switch.

### 2.2 Turning on the Controller/Furnace

Switch power switch to "I" position. The controller first displays the controller type and version number and then the temperature display. If the temperature is displayed, the controller is ready to operate.

Turning on the controller



All necessary settings for proper function have already been done at the factory. For the B 130 and C 280, heating programs for baking and glazing (see chapter "Preconfigured programs for the B 130/C 280") are configured. For the other controllers, the heating programs must be configured on a process- or user-specific basis.

#### Note

Some new functions depend on the version number. Turn the controller off and on again briefly to be able to read the version number.

### 2.3 Turning off the Controller/Furnace

Turn off main switch at position "O".

#### Note

Stop running heating programs before turning the furnace off at the main switch, since the controller will otherwise generate a fault message when it is turned back on. See Faults/fault messages

### 3 Control Fields and Display

#### B 180

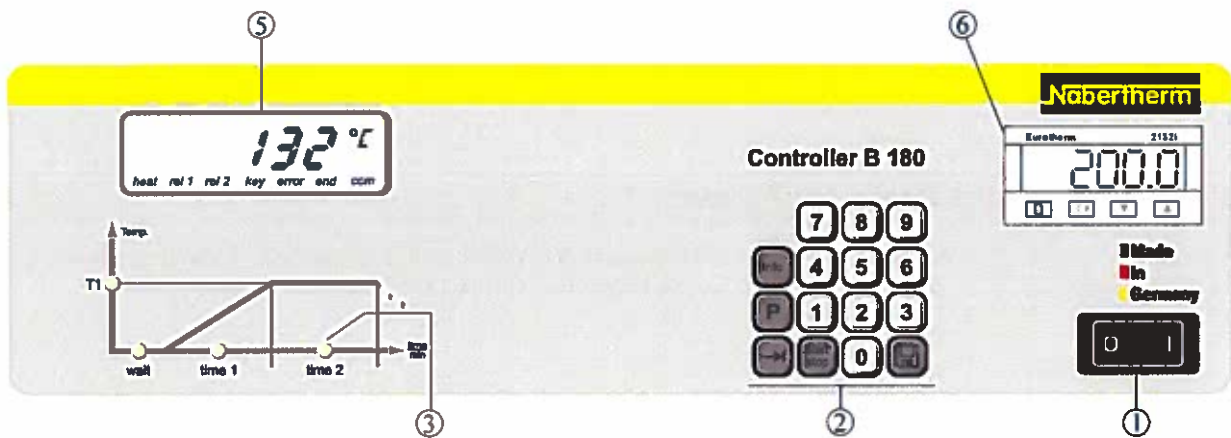

Fig. 1: B 180 control panel

#### P 330

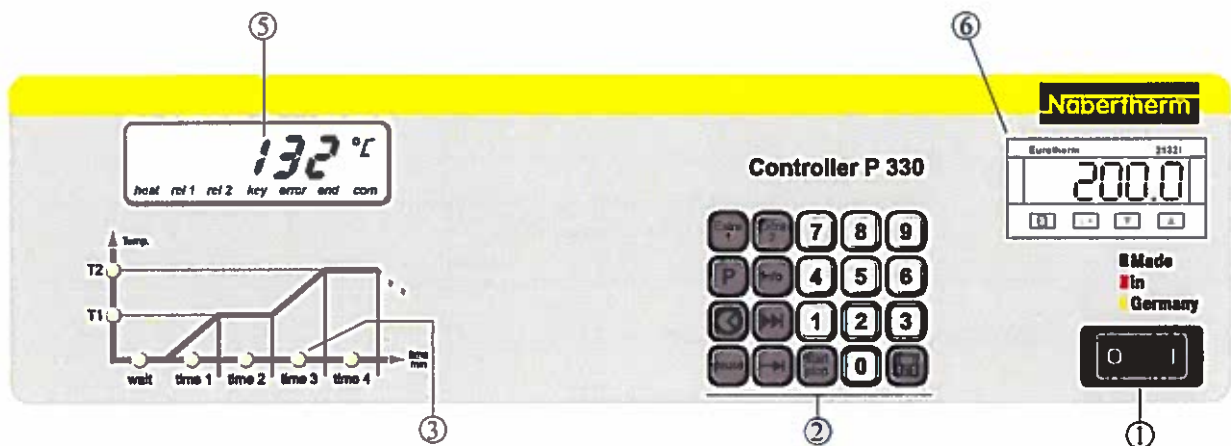

Fig. 2: P 330 control panel

- 1 = Power switch
- 2 = Keyboard block
- 3 = Program LED
- 4 = - - -
- 5 = Display
- 6 = Over-temperature limit controller (optional)

**P 300/P 310**

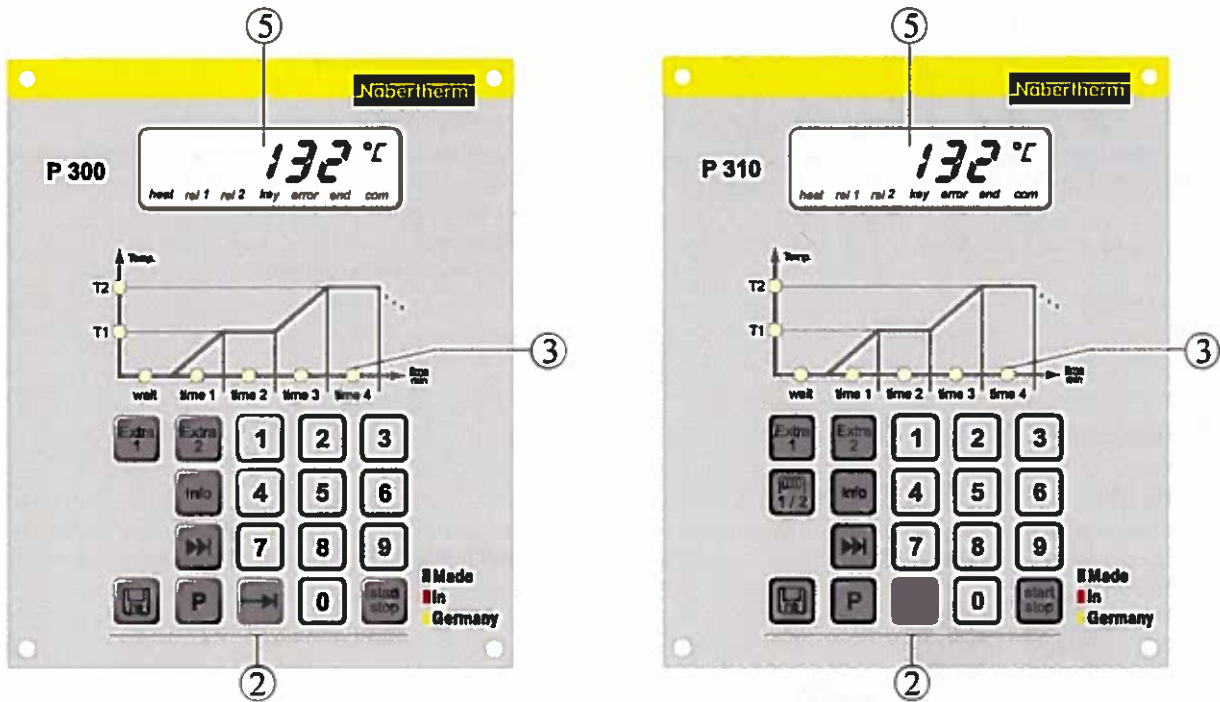

Fig. 3: P 300/P 310 control panel

**B 150/B 130/C 280**

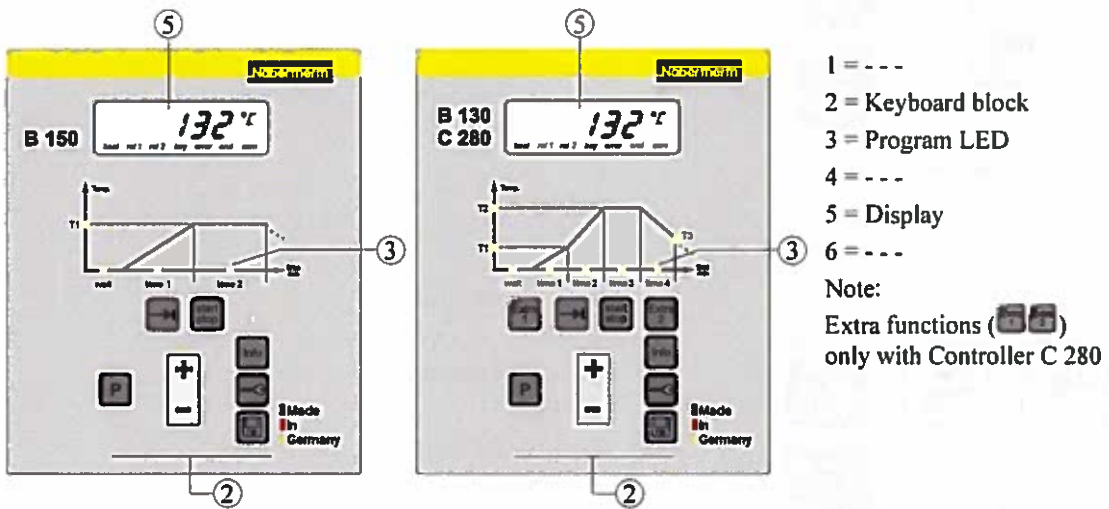

Fig. 4: B 150/B 130/C 280 control panel

### 3.1 Display

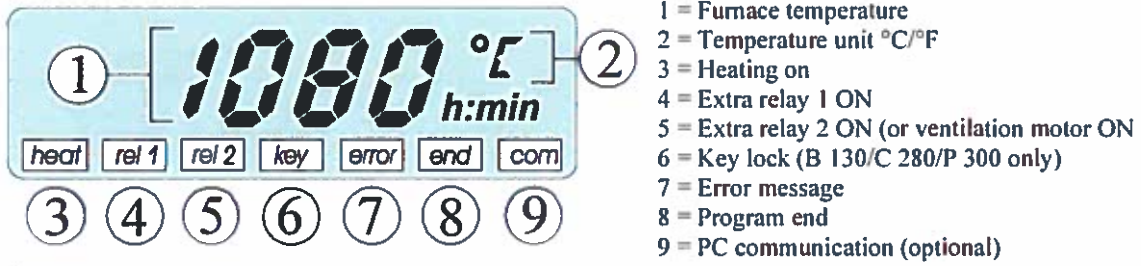

Fig. 5: Display

### 3.2 Keyboard Blocks

#### B 130/B 150

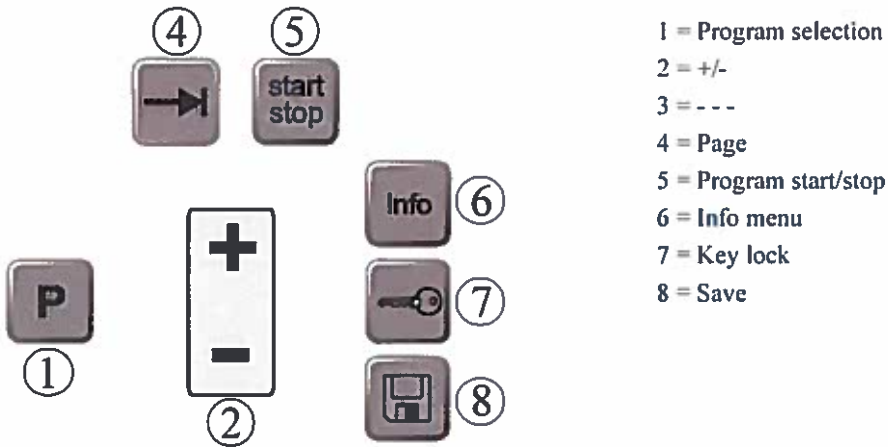

Fig. 6: B 130/B 150 keyboard block

#### C 280

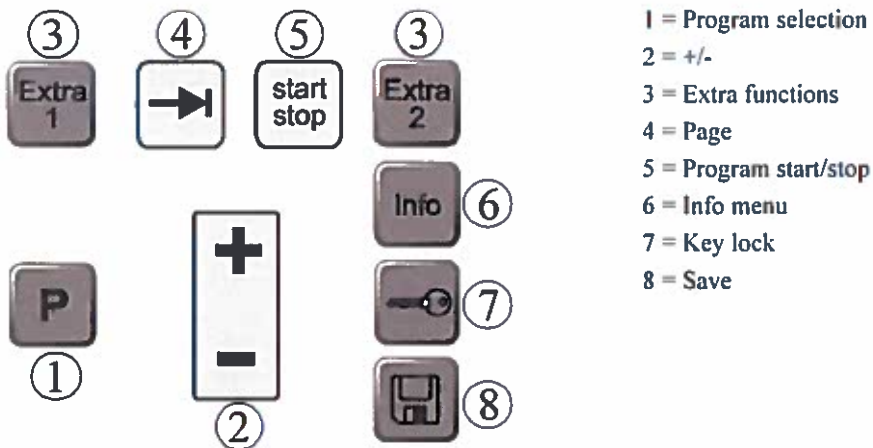
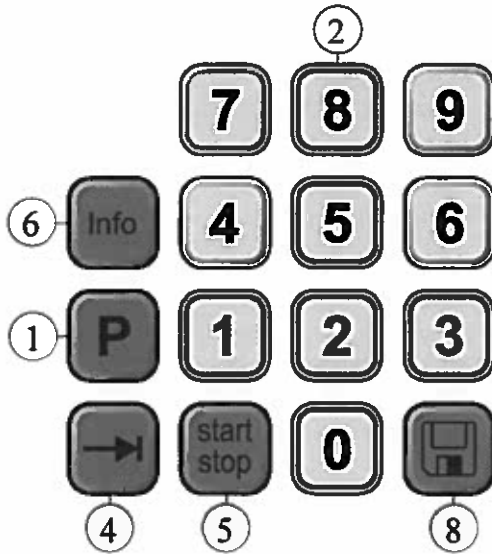

Fig. 7: C 280 keyboard block

## B 180



- 1 = Program selection
- 2 = Numerical block
- 3 = ---
- 4 = Page
- 5 = Program start/stop
- 6 = Info menu
- 7 = ---
- 8 = Save

Fig. 8: B 180 keyboard block

## P 300

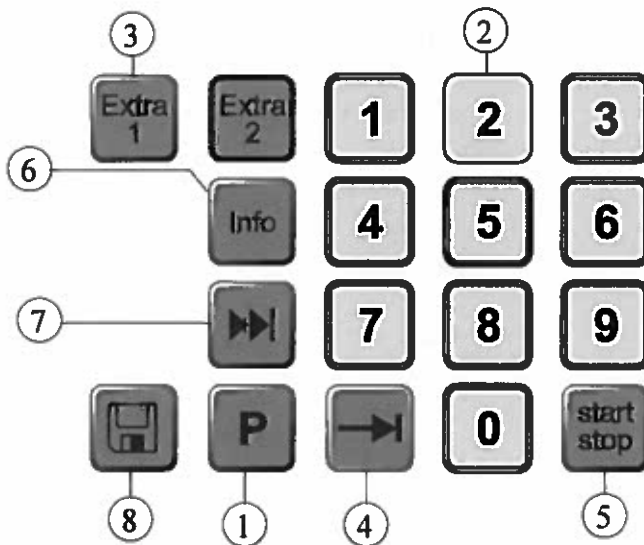

- 1 = Program selection
- 2 = Numerical block
- 3 = Extra functions
- 4 = Page
- 5 = Program start/stop
- 6 = Info menu
- 7 = Segment skip
- 8 = Save

Fig. 9: P 300 keyboard block

**P 310**

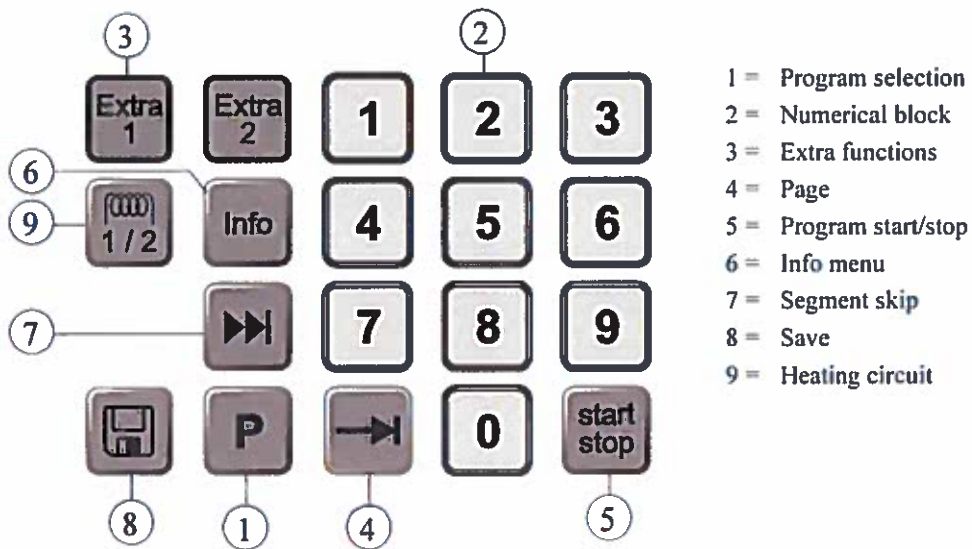

Fig. 10: P 310 keyboard block

**P 330**

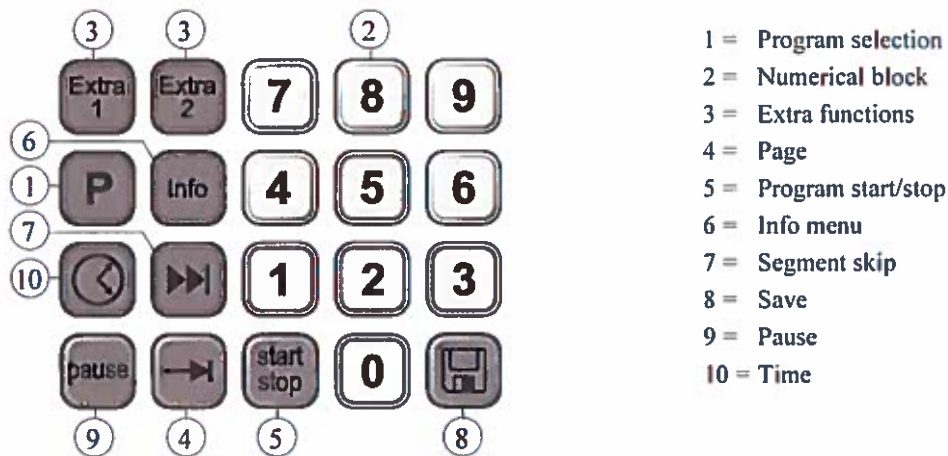

Fig. 11: P 330 keyboard block

## 4 Features of the Controller

### 4.1 Functions

Controller	B 130	B 150	B180	C 280	P 300	P 310	P 330
<b>Function</b>							
Over-temperature protection <sup>1)</sup>	√	√	√	√	√	√	√
Extra relay function	-	-	-	2	2 <sup>4)</sup>	2 <sup>4)</sup>	2 <sup>4)</sup>
Manual configuration of the heating circuits	-	-	-	-	-	√	-
Air circulation motor control <sup>2)</sup>		√	√	√	√	√	√
Waiting time	√	√	√	√	√	√	√
Number of programs	2	1	1	9	9	9	9
Number of segments	4	2	2	4	40	40	40
Auto tune	√	√	√	√	√	√	√
kW/hr counter <sup>3)</sup>	√	√	√	√	√	√	√
Operating hours counter	√	√	√	√	√	√	√
Real-time clock	-	-	-	-	-	-	√
Acoustic signal	-	-	-	-	-	-	√ <sup>5)</sup>
RS-422 data interface	Optional	Optional	Optional	Optional	Optional	Optional	Optional
Constant heat output	-	-	-	-	-	√	-
10-key keyboard	-	-	√	-	√	√	√

1) When the program starts, the highest temperature in the program is calculated. If the furnace is 30°C warmer than the highest program temperature for 3 minutes during the program sequence, the controller turns off the heating and the safety relay, and a fault message appears.

2) Preconfigured function for circulation furnaces: Once a program has been started on the controller, the air circulation motor starts. It remains in operation until the program terminates or is interrupted, and the furnace temperature falls back below 80/176 °C/°F. Extra function 2 is no longer available with this function.

3) The kW/hr counter calculates the power theoretically consumed over the time the heater is turned on for a heating program at nominal voltage. However, there may actually be deviations: If the voltage is low, the power consumption displayed will be too high, and for a higher voltage the power consumption displayed will be too low.

4) In furnaces with an air circulation motor, only one extra function is usually available (see furnace operating instructions).

5) Preset function, therefore no 2nd extra function (see Chapter 7.7 "Programming Extra Functions")

## 5 New Functions of the Nabertherm Controller

### 5.1 Program Entry with/without Gradient as of Version 3.xx

As of controller version 3.xx you can enter ramps either as gradients (e.g. 120°C/h) or using the "time and target temperature" combination.

Turn the controller off and on again briefly to be able to read the version number.

The input mode can be changed on a user-specific basis in the configuration in support of the process specification. To change the input mode, see "Configuration"

The mode configured can be seen during program input in a segment, e.g. "time 1", as follows:

For "time and set temperature" input, only °C/°F or the time h is displayed as the input unit. For gradient input, °C/°F and h appear together in the display as the unit. The maximum gradient is 6000°C (fast heating)



#### Note

The unit of time for the gradient input is preset to hours (h) and cannot be changed to minutes.

Example: 100°C/h

### 5.2 Program Starting Behavior for warm Furnaces as of Controller Version 3.xx

If the furnace temperature ① at program start is higher than the set temperature ② of the first segment "T 1", the program start is delayed until the furnace chamber temperature cools to a value of T1 + 10 °C ③. That is, segment "Time 1" is skipped and the program start occurs in the following segment "Time 2".

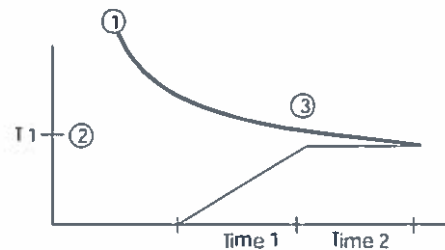

Fig. 12: Program start behavior

This program start behavior is permanently programmed into all controllers as of version number 3.xx and cannot be changed. Turn the controller off and on again briefly to be able to read the version number.

### 5.3 Power Failure Behavior

As of controller version 3.xx the power failure behavior can be configured.

Turn the controller off and on again briefly to be able to read the version number. To change the power failure behavior, see chapter "Configuration/customer-specific settings".



## 6 Controller B 130/C 280

### 6.1 Operating Instructions Summary

Turning on the controller

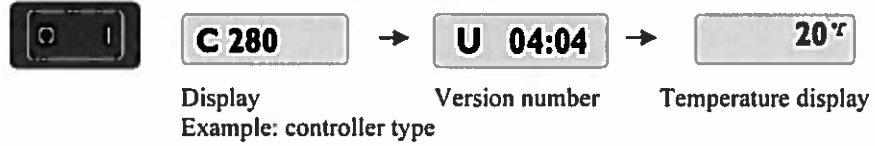

Display  
 Example: controller type

Version number

Temperature display

Call program

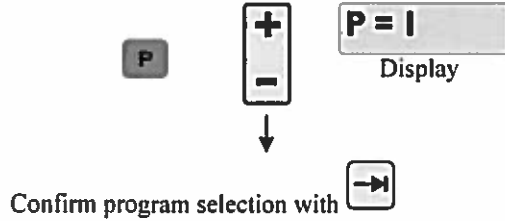

Enter / control program

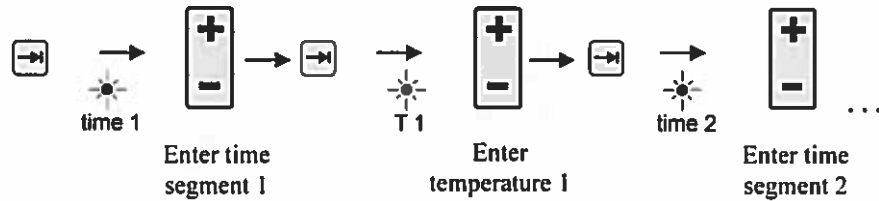

Enter time segment 1

Enter temperature 1

Enter time segment 2

Start program



Display

**Note**  
 Press  for approx. 2 seconds.

## 6.2 Setting or changing Program/Waiting Time

For the automatic operation of the furnace, before starting the controller a temperature characteristic must be configured which describes the desired temperature behavior. This configured temperature behavior is also called a heating program.

Each heating program for the B 130 and C 280 has two ramps, one holding time, and one cooling ramp.

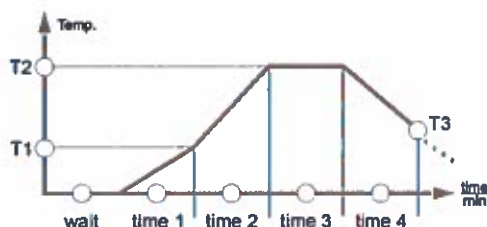

Fig. 13: Program graphic, B 130/C 280

- In the **ramps**, a segment temperature "T" and a segment time, "time 1" and "time 2" define a linear temperature increase (slow heating).
- In the **holding time**, "time 3" determines how long the temperature value configured in "T 2" should be held.
- In the **cooling time**, the natural cooling can be slowed using the rate set in "T 3" and "time 4". If there is no specification in "T 3" and "time 4", the program is already terminated after "time 3" has elapsed.

### Program Entry

Using the paging key  you can enter input mode. Every push selects the following segment or time value. The selected value is displayed with the blinking LED for either "T" or "time".

### Enter / control program

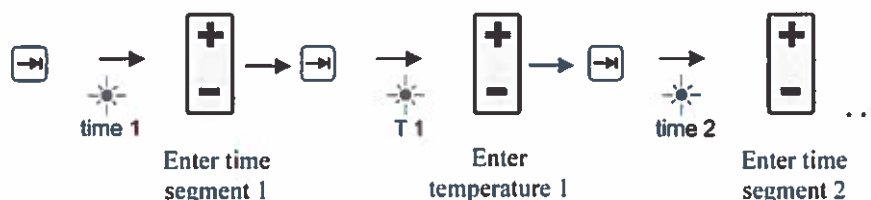

In the display, the temperature value "T" or time value "time" corresponding to the flashing LED is shown.

If the value displayed should not be changed, use the page key  to page to the next temperature or time value.

The display also shows the unit of the value expected:

- set temperature values with °C/°F
- set time specifications with hr:min
- set gradient specifications with °C/hr:min or °F/hr:min

If a value should be changed, you can set it with the  key.

Each time you press the  key, the value changes by 1 °C or by one minute.

If you press the  key, the value first changes in steps of 10,

and if you press the  key for a longer time, the value changes in steps of 100.

Times are entered in hours and minutes, e.g. 6 hr and 30 min as 06:30.

For holding times, an entry of 99:59 means program execution will continue forever.

When input is complete, the program can be started (see Starting the program).

If ramps contain the time entry 00:00, the controller attempts to reach the temperature value stored in "T" as quickly as possible.

If no key is pressed for 60 seconds, the display automatically returns to the display of temperature. Changed settings are initially only buffered. If a changed or new program should be permanently stored in the controller for more frequent use, see "Saving Programs".

#### Note

Not all segments have to be programmed. For segments which are not needed, the temperature and time values must be set to "0". The controller then automatically ends the program after the last segment programmed.

### 6.3 Setting or Changing the Waiting Time

#### B 150/B 180/P 300/P 310 waiting time

To start a heating program automatically at a later point in time, e.g. after a drying time, a waiting time ("wait") can be programmed.

To select the waiting time, press the  key repeatedly until the  LED flashes.

Times are entered in hours and minutes, e.g. 6 hrs and 30 min as 06:30, i.e., when a heating program is started, first the wait time elapses and only then does the program start with segment 1 and heating.

## 6.4 Programming Extra Functions

With controllers of types "C" and "P", up to two optional extra functions "Extra 1" and "Extra 2" can be turned on or off in the segments depending on the program

Extra functions are, for instance, exhaust air flaps, fans, solenoids, or optical and acoustic signals, which have been included in the furnace (if applicable, see additional operating instructions for extra functions)

These extra functions can be specified during program entry in all segments, e.g. "time 1", by selecting the "Extra 1" or "Extra 2" key.

That is, when the controller processes the programmed segment, the extra functions are automatically turned on and then turned back off in the next segment, for instance.

Programming of extra functions is done during program entry.

The desired segment must be selected as described in "Entering programs/wait time", so that the corresponding LED, e.g. "time 1", is flashing.

If the "Extra 1" or "Extra 2" key is now pressed, the extra function is specified for this segment, and in the display the status field "REL 1" lights up for "Extra 1" and/or "REL 2" for "Extra 2". During program execution, the programmed extra function is automatically turned on during this segment.

To turn off the specification of an extra function, press the corresponding "Extra" key again – in the display, the status field "REL 1" or "REL 2" disappears – the extra function is now no longer turned on. Both extra functions can also be activated at the same time.



Fig. 14: Selection of "Extra 1 funktion" in segment "time 1"; LED "time 1" flashes



Fig. 15: In the display, "REL 1" lights up for the selected "Extra 1 funktion"

When paging through the program with , programmed extra functions are indicated in each segment ("time" LED flashing) with the status fields "REL 1" or "REL 2" in the display – if the status fields do not light up, the extra functions are not specified.

### Note



The programming of extra functions is saved along with storage of heating programs!

## 6.5 Programming Extra Functions in "T3" (C 280 only)

When programming extra functions in the program value "T3" (C 280 only), the extra function stays turned on after conclusion of the program, for instance in order to continue cooling the furnace with a cooling fan.

Extra functions which are automatically turned on during program execution by "T3" must be turned off by hand if necessary.

## 6.6 Turning Extra Functions in Program Execution on and off by Hand

Extra functions can be turned on or off during a started program, for the active segment or after termination of the program, by pressing the corresponding   key.

If an extra function is turned on during a running program, it remains on until the program-specific segment transition to the following segment occurs.

### Caution

Press  key for approx. 4 seconds until "key" disappears from the display. The keyboard lock is released. In input mode, if no entry or change is made within approx. 30 seconds, the mode is exited automatically. "Key" appears in the display and the keyboard lock is reactivated.

## 6.7 Saving Programs

Changed settings are initially only buffered. That is, buffered programs are overwritten once a different program is started. If a changed or new program should be permanently saved in the controller for more frequent use, it can be saved to a permanent program slot as follows:

Press the save key  – a program number appears in the display.

The number can be changed to the desired program number using  .

Pressing the save key  again finally saves to the selected program slot.

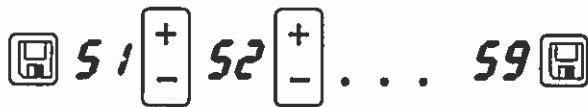



Fig. 16: Saving a program to program slot no. 9

The program can now be called up from this storage slot at any time (see Program start)

### Note

Existing heating programs already saved in a storage slot will be overwritten with no message or warning. Saved heating programs are still retained after the controller is turned off. Configured waiting times are not saved. They must be reentered before each process! The controller automatically returns to the display of the furnace temperature after about 10 seconds when you save without pressing the save key  again. The program is only buffered in this case.

## 6.8 Preconfigured Programs for the B 130/C 280

The following programs are preconfigured and can be started directly.

"Baking" refers to the baking of clay, while "glazing" refers to the baking of glazes.



### Note

In any case, note the specifications and instructions of the raw material manufacturers, which may make it necessary to change or adapt the preconfigured programs. It cannot be guaranteed that optimum results can be obtained with the preconfigured programs. The configured factory programs can be overwritten for your own purposes (see Setting programs/wait time).

### B 130

→	T1	Time1	T2	Time2	Time3	Time4	T3	
P1	650	6:00	900	0:00	0:20	0:00	0	Baking
P2	500	3:00	1050	0:00	0:20	0:00	0	Glazing

### C 280

→	T1	Time1	T2	Time2	Time3	Time4	T3	
P1	650	3:00	900	0:00	0:20	0:00	0	Baking 1
P2	650	6:00	900	0:00	0:20	0:00	0	Baking 2
P3	650	5:00	1100	0:00	0:30	0:00	0	Baking 3
P4	320	2:00	1050	0:00	0:20	0:00	0	Glazing 1
P5	500	3:00	1050	0:00	0:20	0:00	0	Glazing 2
P6	500	3:00	1200	0:00	0:20	0:00	0	Glazing 3
P7								Unused
P8								Unused
P9								Unused



### Note

For furnace models with lower maximum temperatures, the programs listed above are adapted at the factory to the maximum temperature of the furnace.

## 6.9 Calling Programs

Start saved programs with the **P** key. Use the **+** key to select the desired program number and monitor the program using the **→** key.



Fig. 17: Starting heating program no. 9

**Note**

Check the heating program called up before starting it, to be sure that it is the right heating program.

As of version 3, heating programs are reloaded after program termination. That is, the heating program can be started after a process without having to reenter it. Turn the controller off and on again briefly to be able to read the version number .

## 6.10 Program Start

After a heating program is entered or called up, it can be started with the  key.

As of version 3: if the furnace temperature at the starting time is higher than the temperature specified in "T 1", the controller first waits until the temperature of the warm furnace has fallen to the first segment temperature T1, and only then does it start the rest of the program's execution. (See also Chapter "New functions of the Nabertherm controller"). For a cold furnace, the heating program is started immediately.

If the heating program has been started, during program execution the LED of the active segment "time 1 – time 4" lights up. The controller regulates the configured temperature profile completely automatically and the status field "heat" lights up in the heating cycle.

If the waiting time is set, the LED "wait" first lights up and the display counts down the remaining waiting time. The status field "heat" only lights up after program start in segment "time 1" if the heater is turned on. After conclusion of the last segment, the heater is turned off and the program terminates. In the display, the end of the program is indicated with the message "end".

**Note**

Press  for approx. 2 seconds.



## 6.11 Program Change During Execution

During program execution, program changes can be made as follows:

Use the paging key  to enter input mode. Each key press selects the following segment or time value. The selected value is displayed with the flashing LED for either "T" or "time".

In the display, the temperature value "T" or time value "time" corresponding to the flashing LED is shown. Holding times can be changed in steps of 5 minutes and temperatures by +/- 1 °C/°F. If the value displayed should not be changed, use the page key  to page to the next segment or time value. All temperature and time values, as well as the extra functions, can be changed; the only exception is the segment time of the ramp currently being processed.

**Note**

Changes to individual values during program execution must be confirmed with . Otherwise, the change will not be accepted. If you only want to change the active holding time segment, this can be done without selecting using the paging key . To do this, you can use the  key directly to increase or decrease the holding time in steps of five minutes.

Extra functions can be turned on or off during a started program, for the active segment or after termination of the program, by pressing the corresponding "Extra" key.



#### Caution

Press  key for approx. 4 seconds until "key" disappears from the display. The keyboard lock is released. In input mode, if no entry or change is made within approx. 30 seconds, the mode is exited automatically. "Key" appears in the display and the keyboard lock is reactivated.

## 6.12 Terminating a Program

To terminate a program, press  again (press this key for approx. 4 seconds).

The heater is turned off and the status "end" is shown in the display . The program can be terminated at any time.



#### Caution

It is not possible to interrupt a program temporarily.

## 6.13 Key Locking



To prevent unintended or unauthorized interference in the program sequence, the keyboard can be locked permanently with the "keyboard lock" (this can be seen by a flashing symbol in the display). You can only cancel the keyboard lock by switching the controller off and on again. If the furnace is switched off while a program is running, see "Power Failure Behavior", -> press any button to acknowledge the error message.



#### Caution

Press  key for approx. 4 seconds until "key" disappears from the display. The keyboard lock is released. In input mode, if no entry or change is made within approx. 30 seconds, the mode is exited automatically. "Key" appears in the display and the keyboard lock is reactivated.



## 6.14 Info Menu

From the info menu, the current program status, program-relevant information, and fault messages can be read out.

**Info**

You can reach the info menu by pressing the "Info" key.

Use the "Info" key to page through the entire info menu until the furnace temperature is displayed again.

Pr Selected program  
SP Set temperature value  
Pt Program run time of the active/last program, in minutes  
E Power consumption of the active/last program, in kWh  
tt Total operating hours  
OP Heating output power in %  
F1 Fault buffer of last fault  
F2 Fault buffer of next to last fault  
Ht Highest program temperature of the active/last program  
tA Maximum furnace temperature

### Note

The info menu is **not automatically** switched back to the temperature display, so that you can observe it for longer periods of time.

Use the "Info" key to page through the entire info menu until the furnace temperature is displayed again.

Some values are reset after a heating program is started.

The operating hour counter cannot be reset

## 7 Controller B 150/B 180/P 300/P 310/P 330

### 7.1 Operating Instructions Summary B 150

#### Turning on the controller

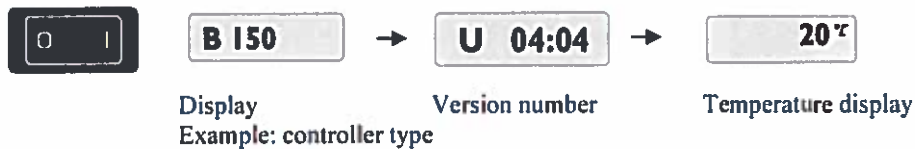

#### Call program

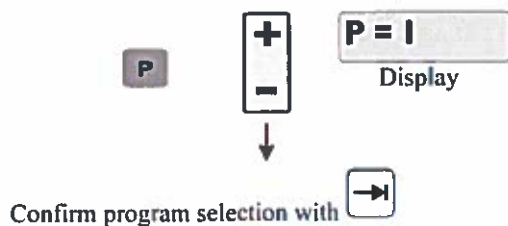

#### Enter / control program

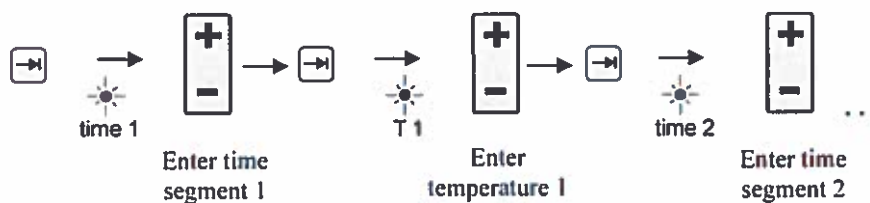

#### Start program

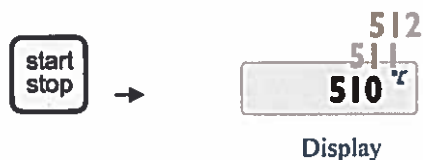

#### Note

Press  for approx. 2 seconds.

## 7.2 Operating Instructions Summary B 180/P 300/P 310/P 330

Turning on the controller



Enter waiting time

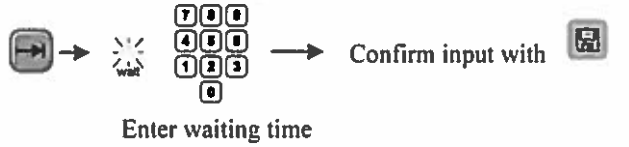

Enter program

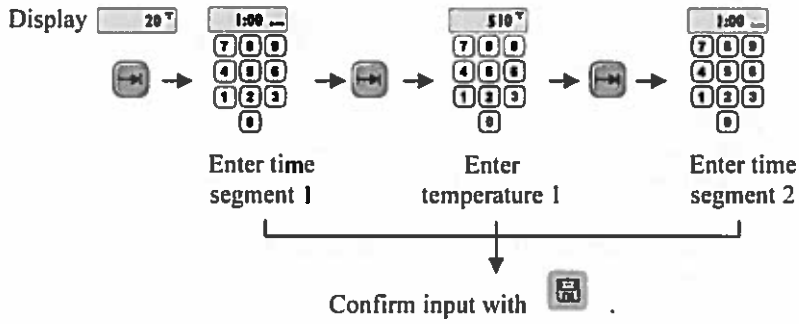

Start program



### Note

Press  for approx. 2 seconds.

### 7.3 Setting and Displaying the Date/Time on the P 330

The P 330 has a real time clock that is set at the factory. The time of day can be displayed by pressing the  key. If the time of day is displayed incorrectly, the clock can be set as follows: The clock is set using a numerical combination of the day of the week and the time. The setting of the day of the week corresponds to the first digit of the numerical combination. Each day of the week has its own number.

1=Mon, 2=Tue, 3=Wed, 4=Thu, 5=Fri, 6=Sat, 7=Sun.

Entry of the time of day must then be carried out with the last four digits of the combination using a 24-hour clock:

E.g. 0735 for 7:35 AM, 1700 for 5:00 PM, etc.

Example: Setting the time "Wednesday (day 3), 7:35 AM"



Fig. 18: Example of setting the clock

The day and time are saved by pressing the  key. They can be queried at any time with the symbol key .

This clock is a real-time clock, that is, even when the controller is turned off, the time is retained using a built-in battery. The lifetime of the battery is about 3 years. When the battery is replaced, the saved data (set time) is lost. For the battery type, see the chapter "Technical data".

The time can only be entered and displayed in 24-hour mode, that is, a display of 12:00 AM/PM is not possible. After the time is set, the controller is fully ready for operation.

### 7.4 Setting or Changing Programs

For the automatic operation of the furnace, before starting the controller a temperature characteristic must be configured which describes the desired temperature behavior. This configured temperature behavior is also called a heating program.

#### B 150/B 180

The heating program for the B 150/B 180 has one ramp and one holding time.

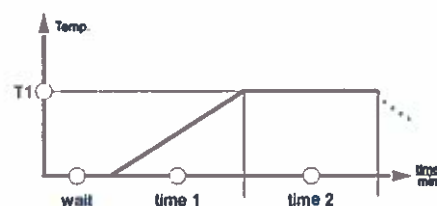



Fig. 19: Program graph, B 150/B 180

- In a ramp, a segment temperature "T" and a segment time, e.g. "time 1", define a linear temperature increase (slow heating).
- In a holding time, e.g. "time 2", it is configured how long the temperature value configured in "T 1" should be held.

**Program input B 150/B 180**

Using the paging key  you can enter input mode. Each key press selects the following segment or time value. The selected value is displayed with the flashing LED for either "T" or "time".

Enter / control program

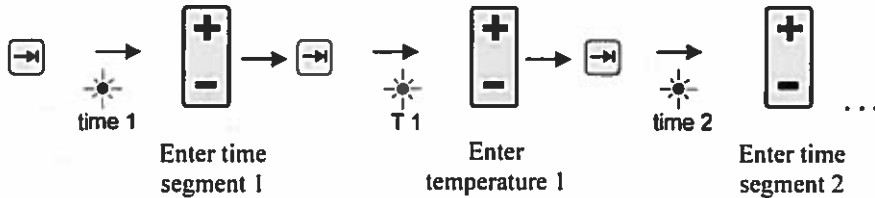

**Note**

For the controllers B 180 the values are entered at the numerical block .

In the display, the corresponding segment block A-I and the temperature value "T" or time value "time" corresponding to the flashing LED are also shown.

If the value displayed should not be changed, use the page key  to page to the next temperature or time value.

The display also shows the unit of the value expected:

- set temperature values with °C/°F
- set time specifications with hr:min
- set gradient specifications with °C/hr:min or °F/hr:min

If a value should be changed, you can set it with the  key.

Each time you press the  key, the value changes by 1 °C or by one minute.

If you press the  key, the value first changes in steps of 10,

and if you press the  key for a longer time, the value changes in steps of 100.

Times are entered in hours and minutes, e.g. 6 hr and 30 min as 06:30.

For holding times, an entry of 99:59 means program execution will continue forever.

When input is complete, the program can be started (see Starting the program).

If ramps contain the time entry 00:00, the controller attempts to reach the temperature value stored in "T" as quickly as possible.

If no key is pressed for 60 seconds, the display automatically returns to the display of temperature. Changed settings are initially only buffered. If a changed or new program should be permanently stored in the controller for more frequent use, see "Saving Programs".

**Note**

Not all segments have to be programmed. For segments which are not needed, the temperature and time values must be set to "0". The controller then automatically ends the program after the last segment programmed.

**P 300/P 310/P 330**

Each of the 9 heating programs for the P 300/P 310/P 330 has 20 ramps and 20 hold times (40 segments in all) which are connected together with the segment blocks A – I.

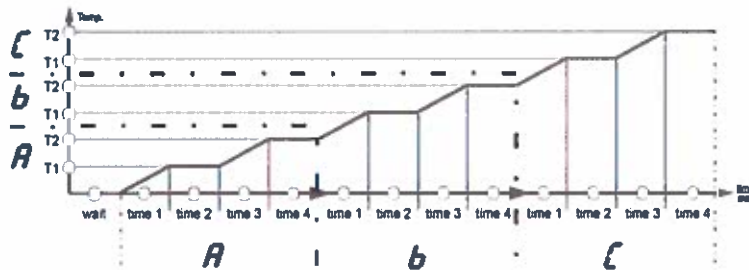
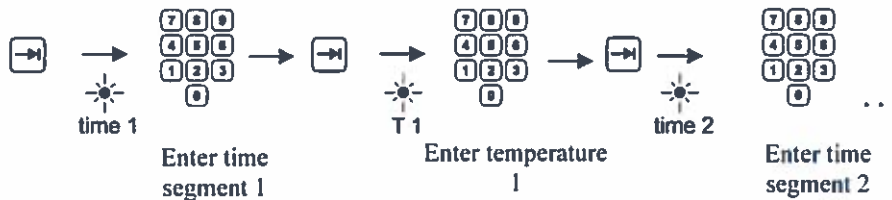

Fig. 20: P 300/P 310/P 330 program graph

Enter / control program



In the display, the corresponding segment block A-I and the temperature value "T" or time value "time" corresponding to the flashing LED are also shown.

If the value displayed should not be changed, use the page key to page to the next temperature or time value.

The display also shows the unit of the value expected:

- set temperature values with °C/°F
- set time specifications with hr:min
- set gradient specifications with °C/hr:min or °F/hr:min

If a value should be changed, you can set it with the numerical block .

Times are entered in hours and minutes, e.g. 6 hr and 30 min as 06:30.

For holding times, an entry of 99:59 means program execution will continue forever. When input is complete, the program can be started (see Starting the program).

If ramps contain the time entry 00:00, the controller attempts to reach the temperature value stored in "T" as quickly as possible

If no key is pressed for 60 seconds, the display automatically returns to the display of temperature. Changed settings are initially only buffered. If a changed or new program should be permanently stored in the controller for more frequent use, see "Saving Programs".

**Note**

Not all segments have to be programmed. For segments which are not needed, the temperature and time values must be set to "0". The controller then automatically ends the program after the last segment programmed



**Note**

It is not permissible to use a ramp segment as hold time. If several consecutive hold times are required, enter the value (0) for the ramp time.

**7.5 Setting or Changing the Waiting Time**

**B 150/B 180/P 300/P 310 waiting time**

To start a heating program automatically at a later point in time, e.g. after a drying time, a waiting time ("wait") can be programmed.

To select the waiting time, press the  key repeatedly until the  LED flashes. Times are entered in hours and minutes, e.g. 6 hrs and 30 min as 06:30, i.e., when a heating program is started, first the wait time elapses and only then does the program start with segment 1 and heating.

**7.6 Setting or changing the Start Time**

**P 330 start time**

To start a heating program automatically at a later point in time, e.g. after a drying time, a waiting time can be programmed via the 7-day timer.

To select the waiting time, press the  key.

The  LED flashes.

The timer is set using a numerical combination consisting of the day of the week and the time. The setting of the day of the week corresponds to the first digit of the numerical combination. Each day of the week has its own number.

1=Mon, 2=Tue, 3=Wed, 4=Thu, 5=Fri, 6=Sat, 7=Sun.

Entry of the time of day must then be carried out with the last four digits of the combination using a 24-hour clock:

e.g. 0800 for 8:00 a.m., 1800 for 6:00 p.m., etc.

Also see "Setting and displaying the date/time"



Example: Program start on Thursday at 08:00.



Fig. 21: Waiting time input

**Note**

Incorrect input:

Exit Wait function by pressing the  key. Press  again to select or correct the wait time.

## 7.7 Programming Extra Functions

With controllers of types "C" and "P", up to two optional extra functions "Extra 1" and "Extra 2" can be turned on or off in the segments depending on the program

Extra functions are, for instance, exhaust air flaps, fans, solenoids, or optical and acoustic signals, which have been included in the furnace (if applicable, see additional operating instructions for extra functions)

These extra functions can be specified during program entry in all segments, e.g. "time 1", by selecting the "Extra 1" or "Extra 2" key.

That is, when the controller processes the programmed segment, the extra functions are automatically turned on and then turned back off in the next segment, for instance.

Programming of extra functions is done during program entry.

The desired segment must be selected as described in "Entering programs/wait time", so that the corresponding LED, e.g. "time 1", is flashing.

If the "Extra 1" or "Extra 2" key is now pressed, the extra function is specified for this segment, and in the display the status field "REL 1" lights up for "Extra 1" and/or "REL 2" for "Extra 2". During program execution, the programmed extra function is automatically turned on during this segment.

To turn off the specification of an extra function, press the corresponding "Extra" key again – in the display, the status field "REL 1" or "REL 2" disappears – the extra function is now no longer turned on. Both extra functions can also be activated at the same time.



Fig. 22: Selection of "Extra 1 funktion" in segment "time 1"; LED "time 1" flashes

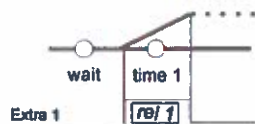



Fig. 23: In the display, "REL 1" lights up for the selected "Extra 1 funktion"

When paging through the program with , programmed extra functions are indicated in each segment ("time" LED flashing) with the status fields "REL 1" or "REL 2" in the display – if the status fields do not light up, the extra functions are not specified.

### Note



The programming of extra functions is saved along with storage of heating programs!

### Note

The P 330 has an acoustic alarm coupled to Extra Relay 1. This means that when the Extra 1 function is activated the acoustic alarm sounds and when the Extra 1 function is deactivated the alarm turns off.



## 7.8 Turning Extra Functions in Program Execution on and off by Hand

Extra functions can be turned on or off during a started program, for the active segment or after termination of the program, by pressing the corresponding   key.

If an extra function is turned on during a running program, it remains on until the program-specific segment transition to the following segment occurs.

### Caution

Press  key for approx. 4 seconds until "key" disappears from the display. The keyboard lock is released. In input mode, if no entry or change is made within approx. 30 seconds, the mode is exited automatically. "Key" appears in the display and the keyboard lock is reactivated.

## 7.9 Saving Programs

Changed settings are initially only buffered. That is, buffered programs are overwritten once a different program is started. If a changed or new program should be permanently saved in the controller for more frequent use, it can be saved to a permanent program slot as follows:

Press the save key  – a program number appears in the display.

The number can be changed to the desired program number using the numerical block .

Pressing the save key  again finally saves to the selected program slot.

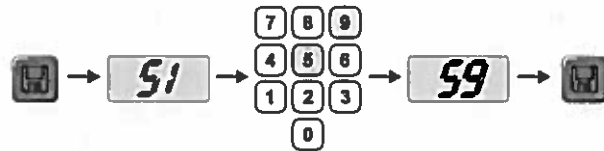



Fig. 24: Saving a program to program slot no. 9





Fig. 25: B 150 example programs

The program can now be called up from this storage slot at any time (see Program start)

### Note

Existing heating programs already saved in a storage slot will be overwritten with no message or warning. Saved heating programs are still retained after the controller is turned off. Configured waiting times are not saved. They must be reentered before each process! The controller automatically returns to the display of the furnace temperature after about 10 seconds when you save without pressing the save key  again. The program is only buffered in this case.

## 7.10 Calling Programs

Start saved programs with the **P** key. Use the numerical block  to select the desired program number and monitor the program using the  key.

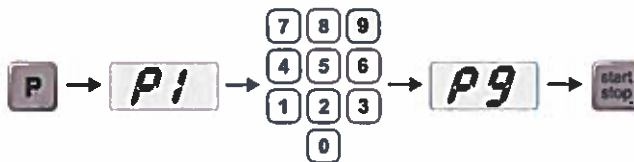

Fig. 26: Starting heating program no. 9

### Note

Check the heating program called up before starting it, to be sure that it is the right heating program.

As of version 3, heating programs are reloaded after program termination. That is, the heating program can be started after a process without having to reenter it. Turn the controller off and on again briefly to be able to read the version number .

## 7.11 Program Start

After a heating program is entered or called up, it can be started with the  key.

As of version 3: if the furnace temperature at the starting time is higher than the temperature specified in "T 1", the controller first waits until the temperature of the warm furnace has fallen to the first segment temperature T1, and only then does it start the rest of the program's execution. (See also Chapter "New functions of the Nabetherm controller"). For a cold furnace, the heating program is started immediately.

If the heating program has been started, during program execution the LED of the active segment "time 1 – time 4" lights up. The controller regulates the configured temperature profile completely automatically and the status field "heat" lights up in the heating cycle.

If the waiting time is set, the LED "wait" first lights up and the display counts down the remaining waiting time. The status field "heat" only lights up after program start in segment "time 1" if the heater is turned on. After conclusion of the last segment, the heater is turned off and the program terminates. In the display, the end of the program is indicated with the message "end".

### Note

Press  for approx. 2 seconds.

## 7.12 Changing Programs during Operation

While the program is running, changes can be made as follows:

Use the scroll key  to access input mode.

Each time you touch the scroll key  you select the following segment or time value. The selected value is shown by the flashing LED "T" or "time".

The temperature value "T" or the time value "time" corresponding to the flashing LED is shown in the display. Hold times can be changed in increments of 1 min and temperatures

by +/- 1°C/°F. If the displayed value is not to be changed, scroll  to the next segment or time value. All temperature and time values and the extra functions can be changed, with the exception of the segment time of the ramp that is currently active.



You must confirm each changed value in the program with the  key, otherwise the change will not be saved.

After you release the keyboard with the  key, you can deactivate extra functions for the active segment during a program that has been started, or with the corresponding "Extra" key after the program has finished.

### Caution

Press  key for approx. 4 seconds until "key" disappears from the display. The keyboard lock is released. In input mode, if no entry or change is made within approx. 30 seconds, the mode is exited automatically. "Key" appears in the display and the keyboard lock is reactivated.

## 7.13 Brief Program Interruption on the P 330

To interrupt program execution only temporarily, for instance to open the furnace door for removal or addition of material, press the "pause"  key. Unlike the "start/stop" key  the heating is still turned off, but the program is not reset (regulation data is retained).

The program is continued with the "start/stop" key  in the last active segment, taking the elapsed time in that segment into account.

If the furnace door is opened without the pause function, the controller immediately reacts to the temperature drop and starts to heat immediately after the door is shut – the result can be an overcompensation in the furnace chamber temperature (see also "Safety" in the furnace operating instructions).

## 7.14 Terminating a Program

To terminate a program, press  again (press this key for approx. 4 seconds).

The heater is turned off and the status "end" is shown in the display . The program can be terminated at any time.

### Caution

It is not possible to interrupt a program temporarily.

## 7.15 Segment Skip Key (P 300/P 310/P 330 only)

Using the  key, the current segment can be shortened or accelerated as follows:

### Segment skip in a ramp

If the program is in a ramp, the  key sets the corresponding ramp time (e.g. "time 1" or "time 3") to zero, so that the controller attempts to reach segment temperature "T" as quickly as possible using maximum power and maximum gradients. After the segment temperature is reached, the segment advances.

### Segment skip in the holding time

If the "Segment skip" key is pressed during a holding time (e.g. "time 2" or "time 4"), then the holding time is ended immediately and the controller jumps directly into the next segment.

#### Caution

Press **P** key for approx. 4 seconds until "key" disappears from the display. The keyboard lock is released. In input mode, if no entry or change is made within approx. 30 seconds, the mode is exited automatically. "Key" appears in the display and the keyboard lock is reactivated.

## 7.16 Heating Circuits Key (P 310 only)

The  key can be used to adapt the power of two heating circuits individually to the process. The controller has two heater outputs whose ratio to one another can be adjusted by selectively reducing the two output lines. At delivery, both heating outputs are set to 100% output power.



By pressing the  key, the configured ratio in the table is initially shown. Use the numerical block  to change this ratio.





Fig. 27: Setting the heating circuit relationship

Display	0	10	20	30	40	50	60	70	80	90	100	110	120	130	140	150	160	170	180	190	200
A1	0 %	10 %	20 %	30 %	40 %	50 %	60 %	70 %	80 %	90 %	100	100	100	100	100	100	100	100	100	100	100
A2	100	100	100	100	100	100	100	100	100	100	90 %	80 %	70 %	60 %	50 %	40 %	30 %	20 %	10 %	0 %	0 %

#### Examples:

1) At the setting "200", the furnace is heated only through output 1 (A1), for instance for a furnace for fusing applications, if only the ceiling heater is to be used and the side or floor heater is to be turned off. Note that when operating with reduced heating power, the furnace may no longer be able to reach the maximum temperature specified on the type plate!

2) At setting "100", the furnace is operated with both heat outputs without reduction, for instance for an even temperature distribution when baking clay and ceramics.

3) At setting "0", output 1, for instance, the ceiling heater in fusing furnaces, is turned off. The furnace is heated only through the heater attached to output 2 (A2), e.g. the side and floor (see the furnace description). Note that when operating with reduced heating power, the furnace may no longer be able to reach the maximum temperature specified on the type plate! Since the configuration of the output power is process-dependent, these settings can be saved directly in the heating program. First enter the heating program as described, and then press the  key to specify the relationship between heating outputs. By saving the heating program, the entire programming including the configured output power can be assigned to a program memory (see also "Saving Programs"). The settings for the output power can also be controlled or changed at any time by pressing the  key. If there is no

other input for 30 seconds, e.g. with the numerical block , the display switches back to display of the temperature.

### Note

See the furnace instructions for which output (A1) (A2) is responsible for which heating zone. In furnaces with two heating circuits, **output 1** always corresponds to the upper heating circuit and **output 2** to the lower one.

## 7.17 Info Menu

From the info menu, the current program status, program-relevant information, and fault messages can be read out.

Info

You can reach the info menu by pressing the "Info" key.

Use the "Info" key to page through the entire info menu until the furnace temperature is displayed again.

Pr	Selected program
SP	Set temperature value
Pt	Program run time of the active/last program, in minutes
E	Power consumption of the active/last program, in kWh
tt	Total operating hours
OP	Heating output power in %
F1	Fault buffer of last fault
F2	Fault buffer of next to last fault
Ht	Highest program temperature of the active/last program
tA	Maximum furnace temperature
H1	Current heat output in % - 1. Heat circulation
H2	Current heat output in % - 2. Heat circulation

### Caution

The "OP" function in the P 310 controller has been replaced by the "H1" and "H2" function.

### Note

The info menu is **not automatically** switched back to the temperature display, so that you can observe it for longer periods of time.

Use the "Info" key to page through the entire info menu until the furnace temperature is displayed again.

Some values are reset after a heating program is started.

The operating hour counter cannot be reset

### Note

For quick assistance in the event of a fault, the data in the info menu are very useful for localizing the fault. In case of a malfunction, please fill out the check list printed from the section "Check List for Controller Complaints" and provide it to us.

## 8 Power Failure Behavior for Version 3.xx Controllers and higher

The power failure behavior describes the behavior of the controller when the power supply is interrupted. The duration of the power failure is irrelevant.

### Ceramic/glass applications

- Program stop in wait segment with fault message F90
- Termination in all other segments with fault message F90
- Continuation from actual value in ramps if  $T > 100\text{ }^{\circ}\text{C}$

### Metal/laboratory applications

Program continuation in any program state.

The power failure behavior configured can be checked or changed under Setting/checking power failure behavior (as of version 3.xx)

## 9 Power Failure Behavior for Controller Versions 1-2.xx, built through the beginning of 2007



### Note

The power failure fault message is only displayed after the first power failure. If multiple power failures in a row occur during a program, this can only be detected by the fact that the "end" indicator is not lit.

### 9.1 Power Failure Behavior in the different Segments of B 130, C 280

**wait/time3/time4:** Program stop with fault message F90  
**time1/time2:** Continuation of program

### 9.2 Power Failure Behavior in the Different Segments of B 180, P 330

**wait:** Program stop with fault message F90  
**time1/time3:** Continuation of the program from actual value  
**time2/time4:** Continuation of the program

### 9.3 Power Failure Behavior for the B 150

**wait:** Program stop with fault message F90  
**time 1:** Continuation of program from actual value  
**time 2:** Program stop if holding time less than 99:59  
**time 2:** Continuation of program if holding time set to 99:59

### 9.4 Power Failure Behavior of P 300/P 310



**wait:** Program stop with fault message F90  
**time 1, time 3:** For  $T < 100^{\circ}\text{C}$  (212°F), continuation of program  
**time 1, time 3:** For  $T > 100^{\circ}\text{C}$  (212°F), stop  
**time 2, time 4:** Program stop if holding time less than 99:59  
**time 2, time 4:** Continuation of the program when holding time set to 99:59

## 10 Eurotherm 2132i Over-Temperature Limit Controller for Installing in Controllers B 180 and P 330 (optional)

### 10.1 Eurotherm 2132i Over-Temperature Limit Controller



The Eurotherm 2132i over-temperature limit controller monitors the furnace chamber temperature using an independent measurement circuit. If the furnace chamber temperature rises above the configured value (generally  $T_{max} + 30\text{ °C}/86\text{ °F}$ ), the heater is turned off by a safety fuse to protect the furnace – "FSH" alarm flashes on the over-temperature limit controller.

If the temperature falls back below the configured value, it must be acknowledged for operation to resume. To do this, the keys  and  must be pressed simultaneously on the over-temperature limit controller in order to enable the heater again.

A temperature selection monitor (option for melting furnaces), unlike the temperature selection limiter, can turn the heating back on after it exceeds the limit. No acknowledgment is necessary.

▶ **Note**

The overtemperature limiter and overtemperature selection monitor (optional) must be checked for proper functioning at regular intervals!

▶ **Note**

See Eurotherm 2132i instructions

## 11 Configuration/Customer-Specific Settings

### 11.1 Configuration



Particular settings which influence the operating behavior of the controller are performed in the configuration. The configuration is divided into two access levels which can be opened with different passwords.

Level 1 = Password 0

Level 2 = Password 2



### 11.2 Opening the Configuration on the B 130/B 150

Press the  key and briefly press the  key, then release the  key again. The display shows "Co 0" and waits for the entry of the security code.

Use  to enter the password for the desired configuration level and confirm with the save key . Page with the  key to show the parameters one after another.

Changed settings must be saved with the  key! During the storage process, the value flashes briefly in the display.

### 11.3 Opening the Configuration for B 180/P 300/P 310/P 330

Press the  key and briefly press the  key. "Co 0" appears in the display, and the system waits for the entry of the password.

Use the keyboard block to enter the password for the configuration level desired and confirm with the  key.

Page with the  key to show the parameters one after another.



Changed settings must be saved with the  key! During the save process, the value flashes briefly in the display.

#### Note

By changing regulation parameters, the function of the control unit can be significantly influenced.

### 11.4 Configuration Options in Configuration Level 1 (Password = "0")

#### 11.4.1 Converting °C/°F

On the configuration level, enter the password "0" and select the parameter "°F", use  or the  to set it to "1" and confirm with the save key .



The safety shutoff in the controller is automatically converted, but all other temperature specifications must be changed to °F.

The preset and subsequent heating programs are always programmed in °C and must be manually adapted after the conversion.





### 11.4.2 Settings for kW/h Counter

For the calculation of electrical power consumption in kW/h in the info menu, you must enter the furnace power from the type plate. The setting is generally already made by Nabertherm.

If this is not the case, select the parameter "PF" in the configuration level and enter the type plate power x 10 with  or the key block and confirm with the save key .  
Example: furnace power 3.6 kW \* 10 = "36" should be entered.

### 11.4.3 Setting the Interface Address

When operating multiple controllers in a data network, different addresses must be configured for the controllers.

On the configuration level, select parameter "Ad", enter the new address (1...99) with  or key block, and confirm with the save key .

#### Note

When operating the controller with furnace monitor software "MV Controltherm", the interface address may not be set higher than 16

### 11.4.4 Program Entry with/without Gradient (as of Version 3.xx)



Select the parameter "rA" in the configuration level, use  or the key block to set the desired input mode, and use the save key  to confirm.

0 = input of ramps without gradient over time and set temperature  
1 = input of ramps with gradient and set temperature

#### Note

The unit of time for the gradient input is preset to hours (h) and cannot be changed to minutes.  
Example: 100°C/h

### 11.4.5 Setting/Control of Power Failure Behavior (Version 3.xx or later)

In the configuration level, select parameter "Ur", set the desired power failure behavior with  or the key block, and confirm with the save key .

0 = e.g. ceramic/glass applications

Interrupt in wait segment

Interrupt in all segments,

continuation from actual value in ramps at  $T > 100^{\circ}\text{C}$

1 = e.g. metal/laboratory applications

Program continuation in any program state.

Hold times are not repeated, but are continued from the time of the power failure with the remaining time.

## 11.5 Configuration Options in Configuration Level 2 (Password = "2")

- PA active parameter set  
Configuration range 0 to 4 (see also auto tune)
  - TU Auto tune  
Configuration range 1 (start)
  - P1 Proportional range XP of the 1st parameter set  
Configuration range from 0 to 100 %
  - I1 Settle time Tn for the 1st parameter set  
Configuration range from 0 to 5000 sec
  - D1 Hold-back time Tv for the 1st parameter set  
Configuration range from 0 to 250 sec
- following parameters sets P2, i2, d2 ... P4, i4, d4

## 11.6 Auto Tune

The regulation parameters of the controller are already set at the factory for the optimum regulation of the furnace. If the regulation behavior is still not sufficient for your process, the regulation behavior can be improved using auto tune.

The controller has four different parameter sets which are already configured for different furnace models. The configured parameter set can be seen in parameter "PA" (see also Configuration). When performing auto tune, the regulation parameters of the selected parameter set are determined and stored using a special measurement procedure.

Start the auto tune process only with a cooled furnace ( $T < 60^{\circ}\text{C}$ ), since otherwise incorrect parameters will be determined for the regulation segment. On the program input level first enter a value for "T1" at which the temperature is to be optimized. Set all times "time" to "00:00"n.

In configuration level 2, select parameter "tu", set it to "1", and confirm with the  key. This will start the auto tune and "tune" will alternate with the furnace temperature in the display. Once the optimization is complete, the status field "end" will show in the display. The parameters determined are stored by the controller into the parameter set for the corresponding temperature range.

Auto tune is always performed at about 70% of the value set in "T1" in any case, to avoid destruction of the furnace, for instance when optimizing the maximum temperature. Auto tune may take more than 3 hours for some models, depending on the furnace type and temperature range. The regulation behavior may be degraded in other temperature ranges after an auto tune! Nabertherm assumes no liability for damage caused by manual or automatic changes to the regulation parameters (see also Temperature-dependent parameter sets).

### Note

Perform an auto tune, if necessary, for all temperature ranges.

## 12 Data Interface

### 12.1 RS-422 Data Interface (optional)

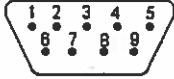

All controllers can be equipped with a RS-422 data interface, which is optionally implemented with a 9-pin D-Sub connector. This interface can be used to send or receive both control functions and archival data. Data exchange is indicated by the "com" (PC communication) indicator in the display.

The interface is immediately ready for operation; e.g for the Nabertherm furnace monitoring software "Controltherm MV"

When operating multiple controllers/furnaces on a data network, the interfaces must be set to different addresses and changed if necessary (see Setting the interface address).

#### Note

If the data connection line between the furnace and the PC or notebook must be longer than 20m, an optionally available interface power supply (order no. 540100193) may be necessary to avoid communication errors.

If the Nabertherm furnace monitor package "MV-Controltherm" is not used, the RS422 interface must be equipped with an additional +5 volt power supply. The power supply is needed by the galvanically isolated driver components of the controller. For this purpose, for instance, an external interface switching power supply for the 9-pin D-Sub plug connector can be ordered (order number 540 100 193).

## 13 Faults

### 13.1 Fault Messages

If a fault message occurs, one of the following fault messages (fault codes) is displayed:

Fault code	Meaning	Comment
F 10	The furnace is not reaching the configured temperature	E.g. heater defective, door not closed, or door contact switch incorrectly adjusted
F 30 – 32	Fault in thermocouple or measurement circuit	Thermocouple defective
F 40	Thermocouple polarity reversed	E.g. after replacement of thermocouple – switch polarity
F 50	Specification of temperature or time incorrect	Correct entry
F 60 – 61	Controller system fault	Controller defective
F 62	Ambient temperature too low <-10°C (-50 °F)	Heat room if necessary
F 63	Ambient temperature too high >70 °C (158 °F)	Ventilate room if necessary
F 64 – 69	Controller system fault	Controller defective
F 70	Furnace temperature has exceeded the permitted value "Tmax"	Switching system or controller defective
F 85	External fault	See furnace operating instructions
F 90	Power failure	Appears after power restored

Fault messages can be reset by turning the power switch off and back on. Leave the unit switched off for at least 5 seconds. If the fault message no longer occurs within a minute after power is turned on, the controller is ready to operate. If there is another fault message, contact Nabertherm service. Ventilation motors (if present) remain on even in case of a fault. The heater is always turned off

## 14 Fault Diagnosis

Fault	Cause	Action
<b>Controller does not light up</b>	Controller turned off	Power switch to "I"
	No power available	Power plug in outlet? Check building circuit breaker/fuse
<b>Furnace not heating</b>	Door/lid open	Close door/lid
	Door contact switch actuated	Check door contact switch
	"wait" displayed	Set waiting time to "00:00"
	No temperature input	Check temperatures T1/T2
<b>Program doesn't go to next segment</b>	In one time segment, the holding time is set to infinity	Set a holding time less than 99:59
<b>Regulator doesn't heat during optimization</b>	No temperature set in "T1"	The temperature to optimize must be entered in "T1"

## 14.1 Controller Check List

Customer: \_\_\_\_\_

Furnace type: \_\_\_\_\_

Furnace ser. no.: \_\_\_\_\_

Controller type: \_\_\_\_\_

Controller ser. no.: \_\_\_\_\_

Controller version: \_\_\_\_\_

↳(appears in the display after system switched on)

Fault code in the display:			
The following faults depend on external factors:	F 62 Ambient temperature too low: <-10 °C (-50 °F) F 63 Ambient temperature too high: > 70 °C (158 °F) F 90 Power failure/running program switched off at power switch		
Exact description of fault:			
Info menu Parameter Pr		Info menu Parameter OP	
Info menu Parameter SP		Info menu Parameter F1	
Info menu Parameter Pt		Info menu Parameter F2	
Info menu Parameter E		Info menu Parameter Ht	
Info menu Parameter tt		Info menu Parameter tA	
Programmed firing curve; please record all values (such as: T1, time 1, etc.)			
When does the fault occur?	At certain places in the program or at certain times of the day:  At certain temperatures:		
Since when has the fault existed?	<input type="checkbox"/> The fault occurred for the first time <input type="checkbox"/> The fault has been occurring for some time <input type="checkbox"/> Unknown		
Fault frequency:	<input type="checkbox"/> Fault occurs frequently <input type="checkbox"/> Fault occurs regularly <input type="checkbox"/> Fault occurs rarely <input type="checkbox"/> Unknown		
Replacement controller:	Has a replacement controller already been used? <input type="checkbox"/> yes <input type="checkbox"/> no Does the fault persist with the replacement controller? <input type="checkbox"/> yes <input type="checkbox"/> no Checked according to troubleshooting list (see furnace operating instructions)? <input type="checkbox"/> yes <input type="checkbox"/> no		

Please enter the following test program so that the furnace heats at full capacity:

Controller B130 / C280

Program point	Value
time 1	0
T1	500
T2	500
time 2	30
time 3	0

(all other values set to "0")

Controller B180 / B150 / P300 / P310 / P330

Program point	Value
time 1	0
T1	500
time 2	30

(all other values set to "0")

Close door/lid and start example program

Please check the following items:

- Is the furnace heating (temperature increase)?
- Does the display show "heat"?
- Does the green LED go on for time 1 or time 2?

During the heating phase open the Info menu for further detailed information.

The following data from the Info menu are important

Menu item	Value
SP	
OP	

Scroll through the menu by repeatedly pressing the Info button. To exit the menu, press the button again until the furnace temperature is displayed.

\_\_\_\_\_

Date

\_\_\_\_\_

Name

\_\_\_\_\_

Signature

## 15 Replacement Parts

### 15.1 Replacing a Built-in Controller



#### **Warning! Danger due to electrical current!**

Work on the electrical systems may only be performed by a qualified electrician!  
Replacement may only be performed by a technical expert!



#### **Note**

Be sure that the power switch is on "0"!  
Always unplug the power cord before opening the housing!  
If the furnace does not have a power cord, disconnect the power to the fixed connection.

#### **Disassembly**

- Remove the 4 screw fasteners from the front side of the controller.
- Tilt the top of the controller carefully out of the housing.
- If present, pull the connector of the flat flexible cable for the interface
- Disconnect the grounding conductor (green/yellow) at the controller.
- Pull both plug connectors (orange).
- Pull the controller gently by the wires out of the housing



Fig. 28: Replacing a controller

#### **Assembly**

- Plug both plug connectors onto the new controller.
- Fasten the ground connector to the controller.
- Check the ground connections of the orange and gray measurement lines.
- If applicable, fasten the plug of the interface line.
- Check for correct connection of the grounding conductor before installing the controller.
- Place the controller back into the installation space.
- Check that no cables are protruding or caught.



#### **Note**

Batteries and electrical parts do not belong in ordinary garbage. Never dispose of batteries in fire, since they can leak or explode. Dispose of unusable material at the appropriate disposal facility. Follow national environmental regulations!



## 16 Specifications



Electrical specifications are on the type plate located on the side of the furnace.

Supply voltage	~100 V – 240 V 50/60 Hz	
Power consumption	3.5 W	
Sensor input	Type S, K, R	
Sensor input	Type B	only B 180/C 295/P 300/ P 310/P 330
Heater output 1	12 V, max. 130 mA	
Heater output 2	12 V, max. 130 mA	only C 295/P 310
Heater output 3	Continuous 0 – 5 V, 0 – 10 V	only C 295/P 310
Safety relay	~250 V/16 A	
Extra relay	~250 V/3 A	not B 130

Real-time clock		only P 330
Buzzer		only P 330
Battery	3 V/285 mA Lithium Model: CR2430	only P 330

Protection rating:	I (protective ground)	
Protection class	Keyboard film IP 65	
	Installation housing IP 20	
	Furnace/Switching system	(see furnace operating instructions)

Interface	RS 422 isolated	optional
-----------	-----------------	----------

Measurement accuracy:	+/- 3°C	
Lowest possible rate	0.25°C/h for input without gradient 1°C/h for input with gradient	

Ambient conditions		
Storage temperature	- 20°C to + 75°C	
Working temperature	0 to 40°C	Ensure sufficient air circulation
Relative humidity:	5 – 90 %	not condensing

## 17 Electrical Connections (Circuit Diagram)

### 17.1 Furnaces up to 3.6 kW – B 130, B 150, B 180, C 280, P 330 through 12/2008

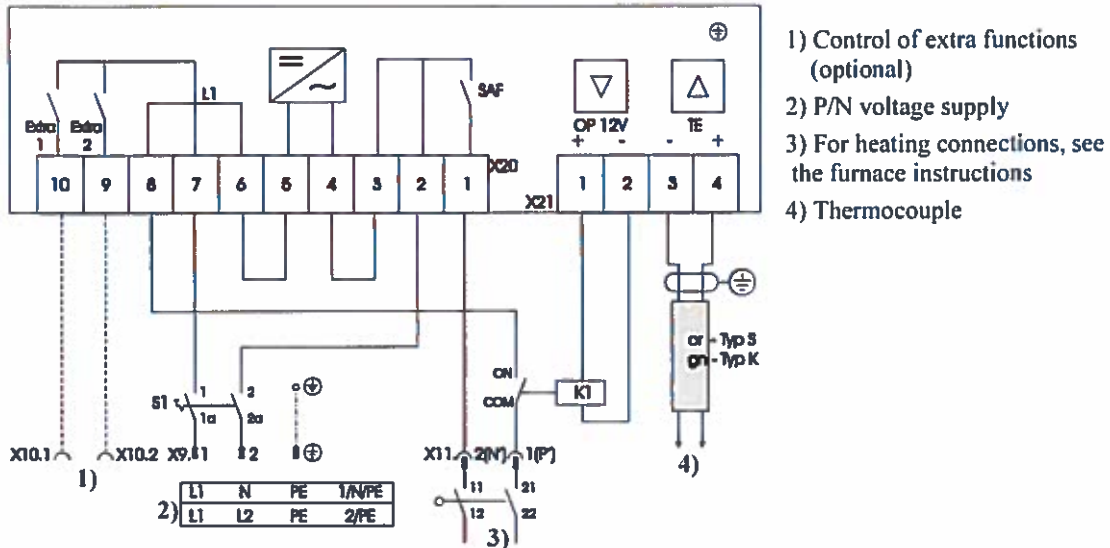

Fig. 29: Furnaces up to 3.6 kW

### 17.2 Furnaces up to 3.6 kW – B 130, B 150, B 180, C 280, P 330 as of 01/2009

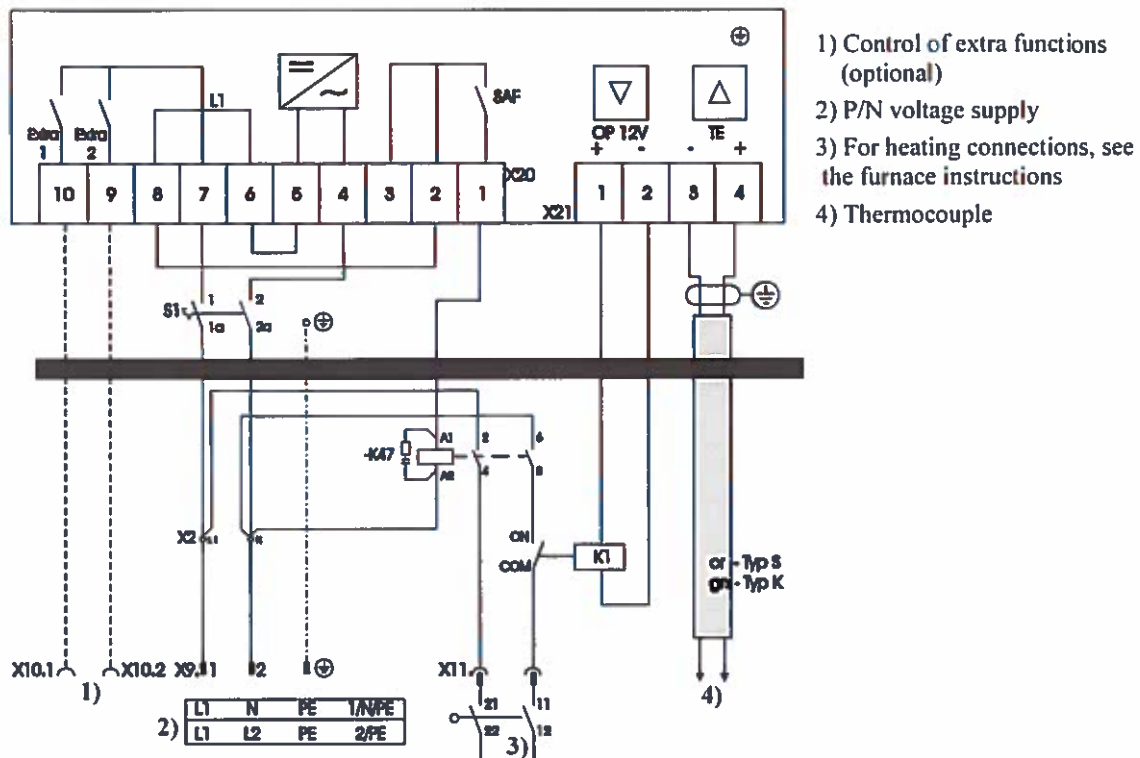

Fig. 30: Furnaces up to 3.6 kW



## 17.5 Furnaces > 3.6 kW with 2 Heating Circuits – P 310

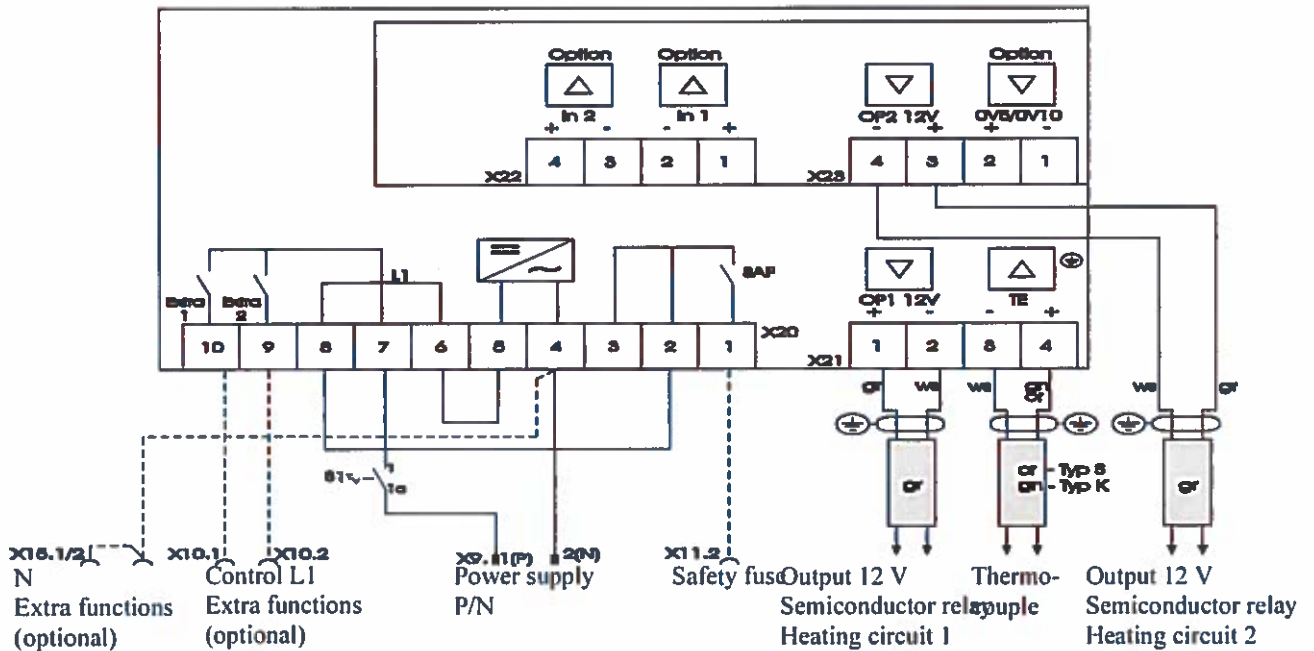

Fig. 33: Furnaces > 3.6 kW with two heating circuits – P 310

## 17.6 Replacement Controller for Models C/S 3; C/S 5; C/S 7; C/S 8; C/S 19; C/S 30

### 17.6.1 Replacement for S 3 – S 30 Controllers through 12/2008

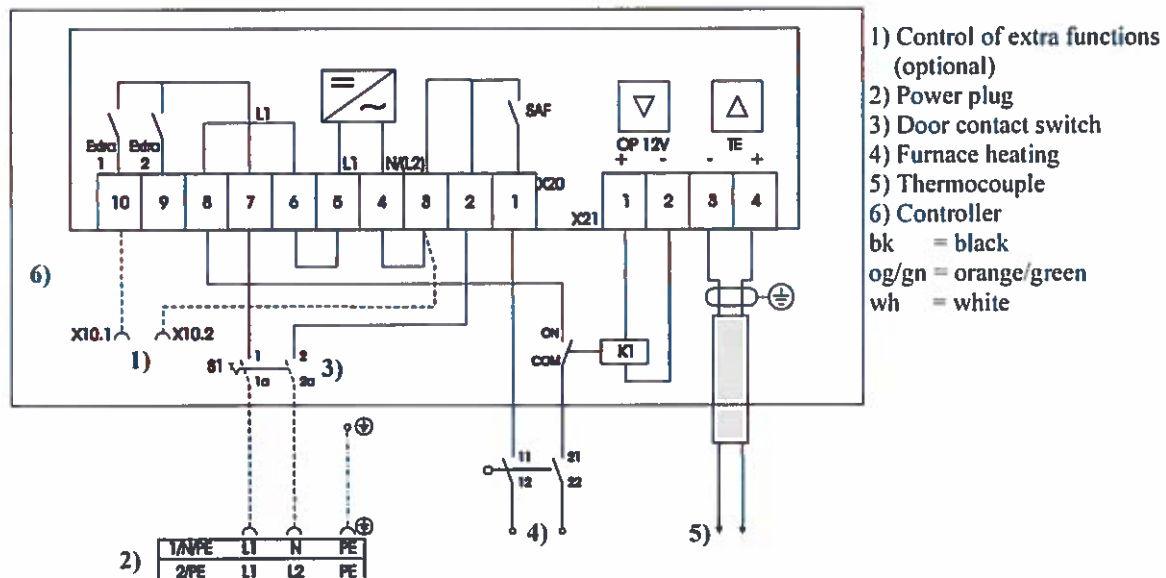

Fig. 34: Replacement for old S controller up to 3.6 kW

## 17.6.2 Replacement for S 3 – S 30 Controllers as of 01/2009

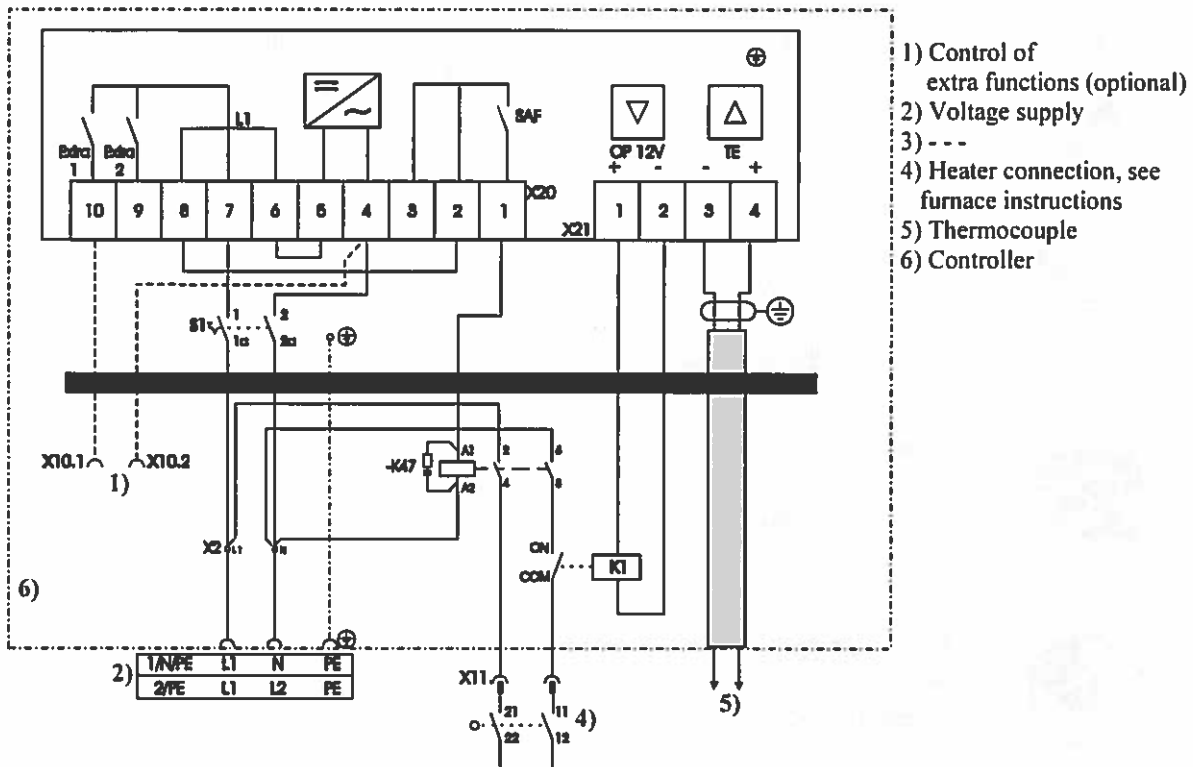

Fig. 35: Replacement for S controller

## 17.6.3 Replacement for C 3 – C 30 Controller

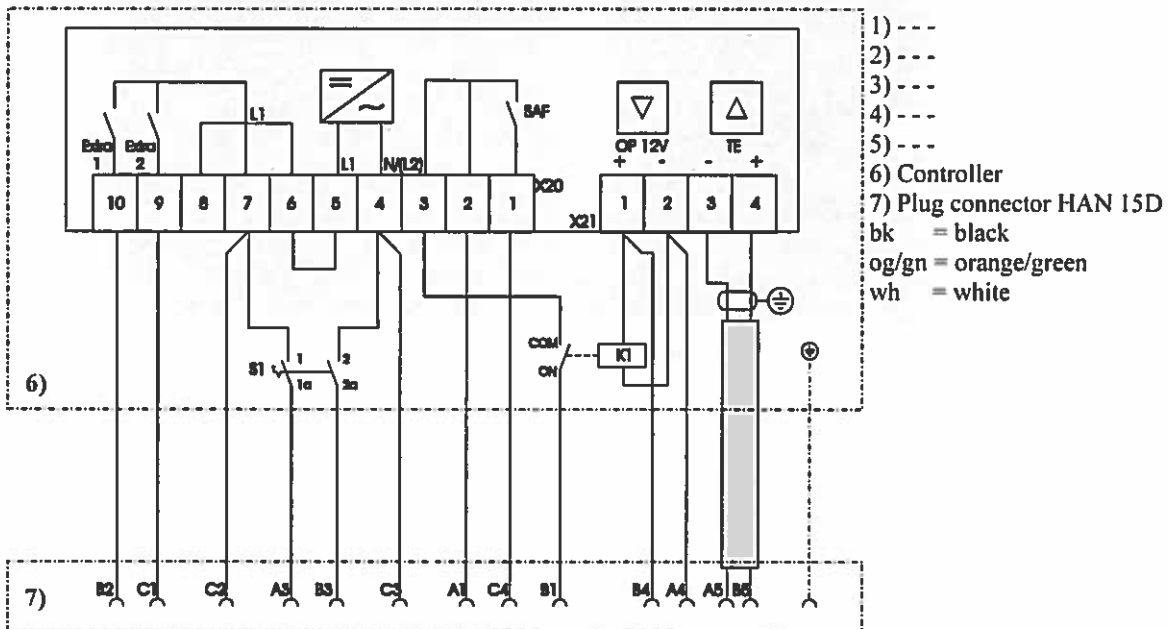

Fig. 36: Replacement C-controller

## 18 Nabertherm Service



Contact Nabertherm Service at any time for maintenance and repair.

If you have any questions, problems, or requirements, contact Nabertherm GmbH. By mail, phone or e-mail.



### Mail

Nabertherm GmbH  
Bahnhofstrasse 20  
28865 Lilienthal/Germany



### Phone or Fax

Phone: +49 (4298) 922-0  
Fax: +49 (4298) 922-129



### Web or e-mail

[www.nabertherm.com](http://www.nabertherm.com)  
[contact@nabertherm.com](mailto:contact@nabertherm.com)

When you contact us, please have the type plate details of the furnace or controller at hand.



Fig. 37: Example: Type plate

**19 For Your Notes**



A series of horizontal lines for writing notes, starting from the top of the page and extending down to the bottom.

**Headquarters:**

Nabertherm GmbH Bahnhofstr. 20 28865 Lilienthal/Bremen, Germany Tel +49 (4298) 922-0, Fax -129 [contact@nabertherm.de](mailto:contact@nabertherm.de) [www.nabertherm.com](http://www.nabertherm.com)

Reg. M03.0001 ENGLISH