

How to: IRIS

Preparing prints
Printing models
Maintaining IRIS

Welcome! This is a step-by-step guide on how to use the Mcor IRIS paper 3D printer. Because you are probably going to at one time, Mcor Support can be contacted at:

+353 41 686 2800 or support@mcortechologies.com,

or through their online support centre:

supportcenter.mcor technologies.com/support/home

Let's begin!

First, take a look at the machine:

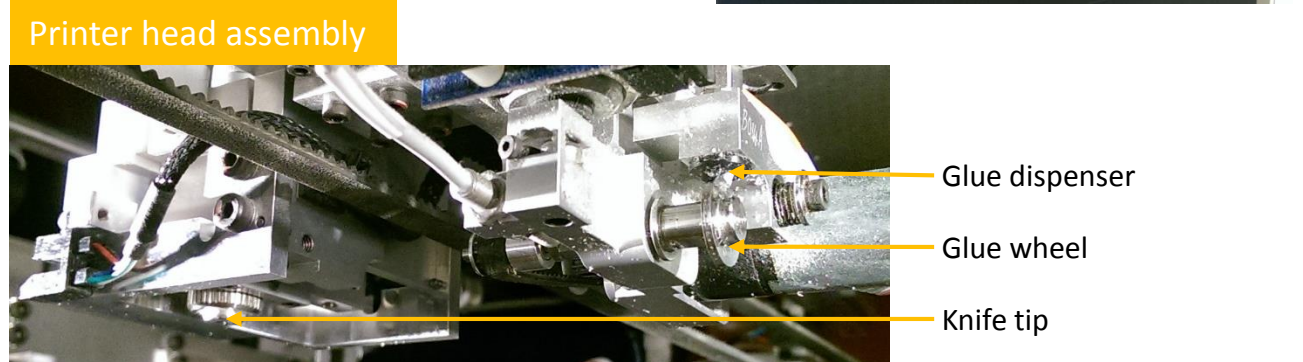
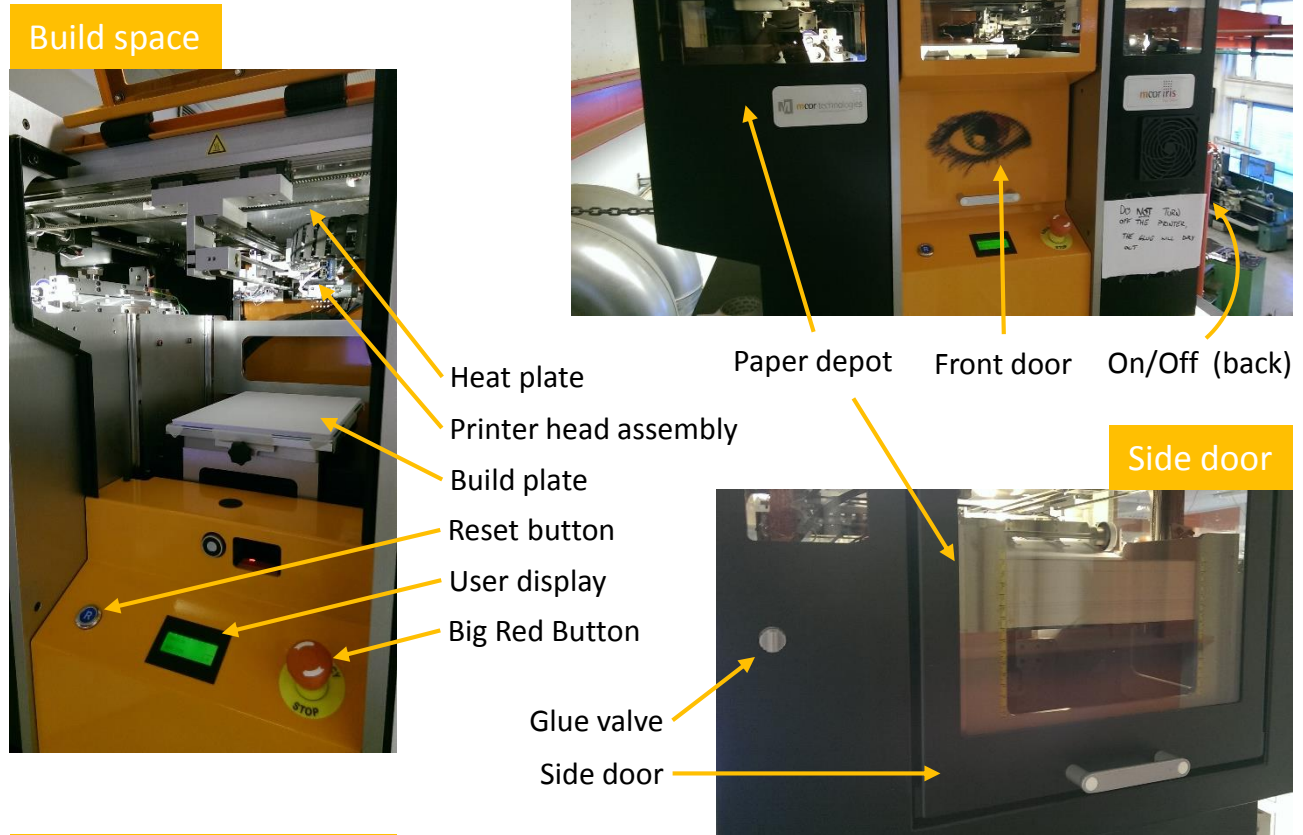

The display says it all

Below is the Standby Mode display, which should appear when the machine is on and not in use. Click the arrow to access the options shown on the right. It is pretty straight forward.

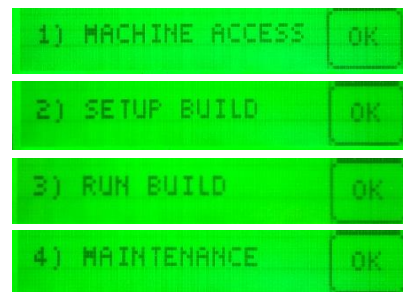

Now that you are familiar with the ins and outs of IRIS, do this:

Prepare the machine:

- 1 Open it up
- 2 Clean the machine
- 3 Change blade
- 4 Prepare the build plate
- 5 Load paper

Print a model:

- 6 Prepare the model
- 7 SliceIT
- 8 Start build
- 9 Pausing the build

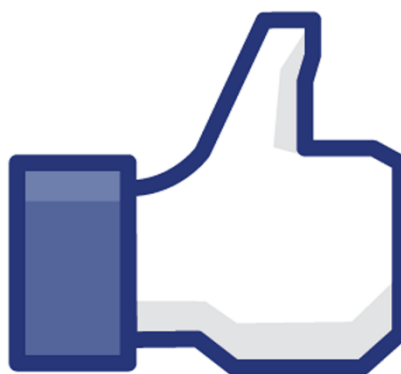

Release model from its paper prison!

Known errors and what to do.

Prepare the machine

1 Open it up

To simply open the machine, chose option 1) Machine Access on the display. This will unlock both doors. To prepare the machine for a build, chose option 2) Setup build – do that now!

2 Clean the machine

Printing with paper is a dirty process, so the machine should be cleaned regularly to prevent stops. Use folded strips of paper, a small brush or a moist sponge to wipe off the internal surfaces, removing paper fibres and glue residue. Closing the glue valve makes the wheel easier to clean.

REMEMBER TO OPEN THE VALVE AGAIN BEFORE YOU PRINT

Open: 

Closed: 

NB: Before every print, make sure there are no pieces of paper or dried glue stuck between the glue wheel's pulley and belt, and to the glue wheel it self. This is known to cause problems. The knife holster should also be cleaned of paper dust; make sure the knife rotates freely.

Mcor videos: [Cleaning printer](#) [Cleaning heat plate](#) [Cleaning rollers](#)

3 Change blade

The blade should be changed after every 5–7 000 meter cutting distance. One model can require anything from 50 to 5 000 meter. As the blade gets duller, the cuts in the paper becomes rugged.

Tip: In SliceIT (See point 7), click Machine Interface → Set Knife Usage to see current distance.

Mcor's video on how to change the blade: [Setting the cutting blade height](#)

4 Prepare build plate

The very first sheet of the build has to be manually fastened to the build plate with masking tape. To remove the build plate from the machine, loosen the screw in the front and lift up the plate. Centre a paper sheet on the plate and fasten it with tape around the edges. Then put it back in the machine and secure the screw.

Mcor video: [Preparing build plate](#)



5 Load paper

To load more paper, open the door on the side. Since you chose 2) Setup up machine, the paper tray should be at the lower position. The machine can hold up to 15 cm of paper sheets, 80gsm (about three stacks of regular office A4 paper). More paper can also be loaded during the build process by pausing the build (point 9).

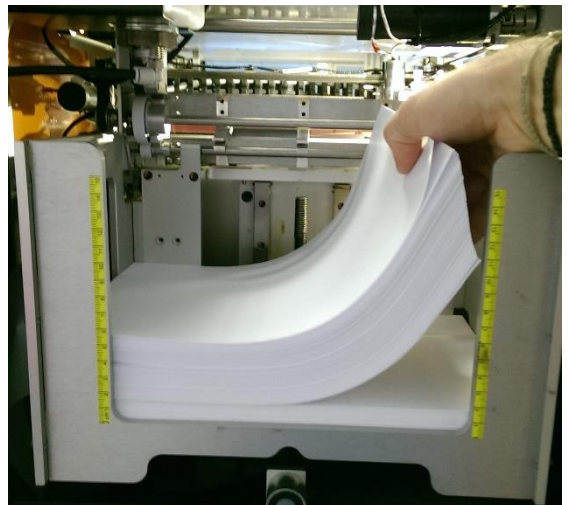

Finally, it is time to:

Print a model

6 Prepare the model

For this guide, download the IRIS Guide Model from Troll Labs wiki:

<https://www.ntnu.no/wiki/display/TrollLABS/MCOR+IRIS>

When creating your own models, keep this in mind:

- Details should be larger than 4 mm in diameter or width, relative to the XY-plane.
- The waste material must be removed manually after the print, which creates some limitations:
 - Closed spaces can not be made hollow.
 - Holes and slots in the model should go all the way through or be conical (larger diameter on top than bottom). Deep holes and slots can be very difficult to dig out.
 - Surfaces in the XY-plane should have slightly rounded edges. This makes it harder to accidentally rip off the top layers when removing the waste material around.
- All surface normals must point outwards.
- Accepted file formats: STL, OBJ, VRML and Collada.

7 SliceIT

SliceIT is IRIS's print preparation program, in which you add and orient your model(s) inside the build space. **NB:** SliceIT has to run while the print is in progress. Explore the command line:

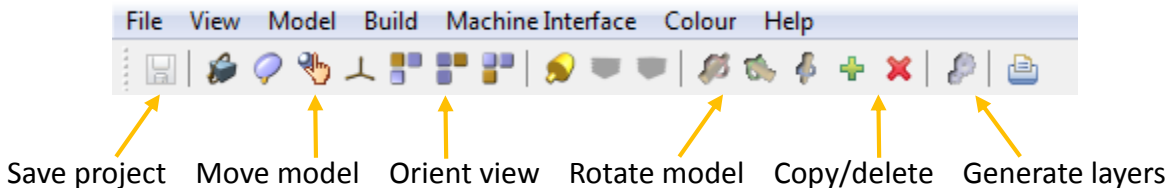

To print a model:

1. Start new project: File → New Project.
2. Right-click project name → Add 3D File to Project. This time, find and chose the example model.
3. Add, move and orient your model(s) inside the build space.
4. When happy, click Generate Layers. This does just that, and gives you information about the build, like on the right.

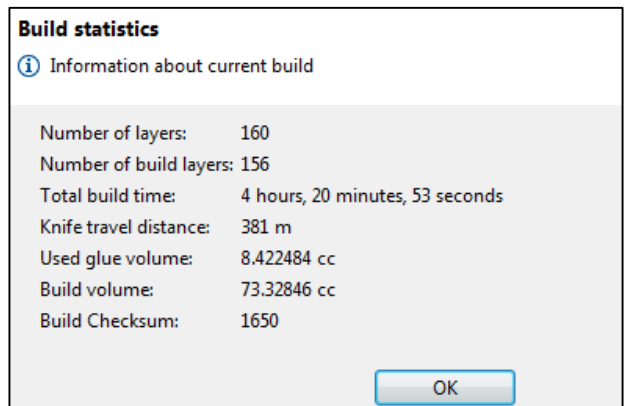
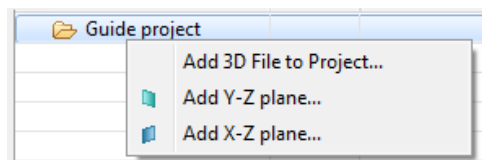

Pro tips:

- Unless layer orientation is critical, orient your model flat to the bottom, making it as low as possible, to reduce build time. If you plan on printing many models, combine those of same or similar height – this is most efficient and makes the digging easier.
- Orient your model(s) with their longest axes parallel to the long side of the page, as this is the direction the glue wheel rolls. This can significantly reduce your build time, like in this example:

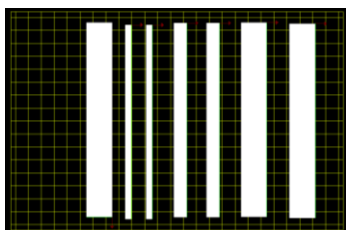

Same pieces:

<- 16 hours
7 hours ->

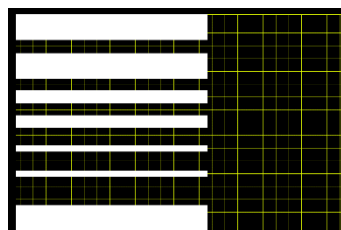

8 Start build

Return to IRIS and click on the Standby arrow.

- If you have done what you should and already prepared the machine, chose option 3) Run Build.
- If not, chose option 2) Setup Build and do point 2–5 of this guide in shame.

The machine should now be ready for printing, displaying «Ready to Print».

Go to SliceIT, click Machine Interface in the toolbar and chose Print Model.

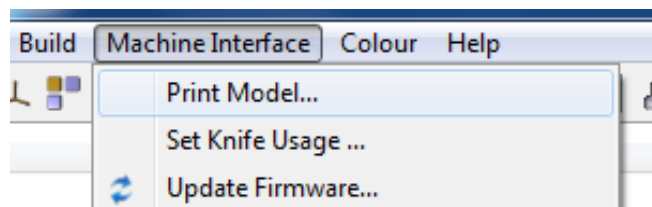

The display should now say «Part Building. Press OK to pause». Now we wait and hope for the best. (In the lower left corner of SliceIT you can see the current layer and remaining build time)

9 Pausing the build

If you want to open the machine while it is building, or simply want to pause the build, go ahead and click OK. The display will change to «Finishing current page, please wait». When it is done, the display will say «Build paused, select an option». Select:

- 1) Machine Access 2) Load Paper 3) Continue Build 4) Terminate Build.

NB: For emergency stops, push the Big Red Button. This will immediately stop the build and unlock the doors. The display will say «Following Error, contact service». Resolve the emergency and then rotate the big red button to release it. Restart the machine using the On/Off button on the back side and let it power up. Do what the display says.

Once the build is finished,

Release model from its paper prison!

If you have come this far, congratulations! You will now have to do the rest manually. The model has to be dug out of the paper block. You should have a good idea of where it is, so remove the outermost waste material forcefully and the material close to your model carefully. A tong, flathead screwdriver, stationary knife and tweezers makes the job a lot easier (on your hands).

Begin with the rim.



Dig, dig, dig



Voilà!

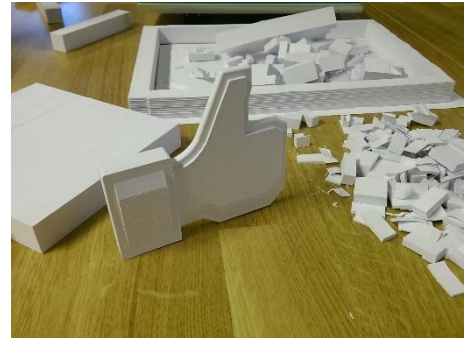

Known errors and what you do

If the error can not be solved in the ways listed here, contact Mcor Support. They will probably ask for the data, log and error files, which can all be found in the SlicelTWorkspace directory on the PC.

Displayed Error	Known cause(s)	Action
«Current Limit»	A motor is overworked, probably because built up dirt, paper debris or glue residue is causing extra strain on it.	Mcor Support can tell you which motor caused the problem if you send them the error files. Thoroughly clean the parts driven by the overworked motor, let IRIS rest and restart the machina via power button.
«Command Error»	A problem with the communication between SlicelT and IRIS.	Restart IRIS and SlicelT, and restart the build from the layer it stopped at.
«Top sheet could not be loaded»	Last sheet of paper was not placed correctly.	Open IRIS, remove the last sheet placed on the build and restart build.
«Following Error»	Something is prohibiting IRIS from printing. Known causes: Jammed paper debris, Emergency button not released, knife not rotating.	Find and remove/resolve the cause of the stop and restart IRIS via power button. If this does not work, clean IRIS thoroughly.