

AC Servo System 1S-series

Startup Guide for Multi-axis Setup and Tuning

R88M-1L[]/-1M[] (AC Servomotors)
R88D-1SN[]-ECT (AC Servo Drives)
SYSMAC-SE20[][] (Automation Software)

Startup
Guide



NOTE

All rights reserved. No part of this publication may be reproduced, stored in a retrieval system, or transmitted, in any form, or by any means, mechanical, photocopying, recording, or otherwise, without the prior written permission of OMRON.

No patent liability is assumed with respect to the use of the information contained herein. Moreover, because OMRON is constantly striving to improve its high-quality products, the information contained in this manual is subject to change without notice. Every precaution has been taken in the preparation of this manual. Nevertheless, OMRON assumes no responsibility for errors or omissions. Neither is any liability assumed for damages resulting from the use of the information contained in this publication.

Introduction

The Servo System 1S-Series Startup Guide for Multi-axis Setup and Tuning (hereinafter, may be referred to as "this Guide") describes the procedures for installation and setup of 1S Servo Drives, where an NJ/NX-series CPU Unit is used in combination with 1S-series AC Servomotors/Servo Drives and NX-series Safety Unit, by using the Sysmac Studio. A simple installation model is used for the discussion. You can perform the procedures that are presented in this Guide to quickly gain a basic understanding of a 1S-series AC Servomotors/Servo Drives.

This Guide does not contain safety information and other details that are required for actual use. Thoroughly read and understand the manuals for all of the devices that are used in this Guide to ensure that the system is used safely. Review the entire contents of these materials, including all safety precautions, precautions for safe use, and precautions for correct use.

Intended Audience

This Guide is intended for the following personnel.

- Personnel in charge of introducing FA systems
- Personnel in charge of designing FA systems

The personnel must also have the following knowledge.

- Knowledge of electrical systems (an electrical engineer or the equivalent)
- Knowledge of NJ/NX-series CPU Units
- Knowledge of Servomotors/Drives
- Knowledge of operation procedure of Sysmac Studio

Applicable Products

This Guide covers the following products.

- CPU Units of NJ/NX-series Machine Automation Controllers
- Automation Software Sysmac Studio
- 1S-series Servomotors/Servo Drives

Special Information

The icons that are used in this Guide are described below.



Precautions for Safe Use

Precautions on what to do and what not to do to ensure safe usage of the product.



Precautions for Correct Use

Precautions on what to do and what not to do to ensure proper operation and performance.



Additional Information

Additional information to read as required.

This information is provided to increase understanding or make operation easier.

Terms and Conditions Agreement

Warranties

(a) Exclusive Warranty. Omron's exclusive warranty is that the Products will be free from defects in materials and workmanship for a period of twelve months from the date of sale by Omron (or such other period expressed in writing by Omron). Omron disclaims all other warranties, express or implied.

(b) Limitations. OMRON MAKES NO WARRANTY OR REPRESENTATION, EXPRESS OR IMPLIED, ABOUT NON-INFRINGEMENT, MERCHANTABILITY OR FITNESS FOR A PARTICULAR PURPOSE OF THE PRODUCTS. BUYER ACKNOWLEDGES THAT IT ALONE HAS DETERMINED THAT THE PRODUCTS WILL SUITABLY MEET THE REQUIREMENTS OF THEIR INTENDED USE.

Omron further disclaims all warranties and responsibility of any type for claims or expenses based on infringement by the Products or otherwise of any intellectual property right. (c) Buyer Remedy.

Omron's sole obligation hereunder shall be, at Omron's election, to (i) replace (in the form originally shipped with Buyer responsible for labor charges for removal or replacement thereof) the non-complying Product, (ii) repair the non-complying Product, or (iii) repay or credit Buyer an amount equal to the purchase price of the non-complying Product; provided that in no event shall Omron be responsible for warranty, repair, indemnity or any other claims or expenses regarding the Products unless Omron's analysis confirms that the Products were properly handled, stored, installed and maintained and not subject to contamination, abuse, misuse or inappropriate modification. Return of any Products by Buyer must be approved in writing by Omron before shipment. Omron Companies shall not be liable for the suitability or unsuitability or the results from the use of Products in combination with any electrical or electronic components, circuits, system assemblies or any other materials or substances or environments. Any advice, recommendations or information given orally or in writing, are not to be construed as an amendment or addition to the above warranty.

See <http://www.omron.com/global/> or contact your Omron representative for published information.

Limitation on Liability; Etc

OMRON COMPANIES SHALL NOT BE LIABLE FOR SPECIAL, INDIRECT, INCIDENTAL, OR CONSEQUENTIAL DAMAGES, LOSS OF PROFITS OR PRODUCTION OR COMMERCIAL LOSS IN ANY WAY CONNECTED WITH THE PRODUCTS, WHETHER SUCH CLAIM IS BASED IN CONTRACT, WARRANTY, NEGLIGENCE OR STRICT LIABILITY.

Further, in no event shall liability of Omron Companies exceed the individual price of the Product on which liability is asserted.

Suitability of Use

Omron Companies shall not be responsible for conformity with any standards, codes or regulations which apply to the combination of the Product in the Buyer's application or use of the Product. At Buyer's request, Omron will provide applicable third party certification

documents identifying ratings and limitations of use which apply to the Product. This information by itself is not sufficient for a complete determination of the suitability of the Product in combination with the end product, machine, system, or other application or use. Buyer shall be solely responsible for determining appropriateness of the particular Product with respect to Buyer's application, product or system. Buyer shall take application responsibility in all cases. NEVER USE THE PRODUCT FOR AN APPLICATION INVOLVING SERIOUS RISK TO LIFE OR PROPERTY WITHOUT ENSURING THAT THE SYSTEM AS A WHOLE HAS BEEN DESIGNED TO ADDRESS THE RISKS, AND THAT THE OMRON PRODUCT(S) IS PROPERLY RATED AND INSTALLED FOR THE INTENDED USE WITHIN THE OVERALL EQUIPMENT OR SYSTEM.

Programmable Products

Omron Companies shall not be responsible for the user's programming of a programmable Product, or any consequence thereof.

Performance Data

Data presented in Omron Company websites, catalogs and other materials is provided as a guide for the user in determining suitability and does not constitute a warranty. It may represent the result of Omron's test conditions, and the user must correlate it to actual application requirements. Actual performance is subject to the Omron's Warranty and Limitations of Liability

Change in Specifications

Product specifications and accessories may be changed at any time based on improvements and other reasons. It is our practice to change part numbers when published ratings or features are changed, or when significant construction changes are made. However, some specifications of the Product may be changed without any notice. When in doubt, special part numbers may be assigned to fix or establish key specifications for your application. Please consult with your Omron's representative at any time to confirm actual specifications of purchased Product.

Errors and Omissions

Information presented by Omron Companies has been checked and is believed to be accurate; however, no responsibility is assumed for clerical, typographical or proofreading errors or omissions.

Precautions

- When building a system, check the specifications for all devices and equipment that will make up the system and make sure that the OMRON products are used well within their rated specifications and performances. Safety measures, such as safety circuits, must be implemented in order to minimize the risks in the event of a malfunction.
- Thoroughly read and understand the manuals for all devices and equipment that will make up the system to ensure that the system is used safely. Review the entire contents of these manuals, including all safety precautions, precautions for safe use, and precautions for correct use.
- Confirm all regulations, standards, and restrictions that the system must adhere to.
- Check the user program for proper execution before you use it for actual operation.

Trademarks

- Sysmac and SYSMAC are trademarks or registered trademarks of OMRON Corporation in Japan and other countries for OMRON factory automation products.
- Windows is either registered trademarks or trademarks of Microsoft Corporation in the USA and other countries.
- EtherCAT[®] is registered trademark and patented technology, licensed by Beckhoff Automation GmbH, Germany.
- Microsoft product screen shot(s) reprinted with permission from Microsoft Corporation.
- Other company names and product names in this Guide are the trademarks or registered trademarks of their respective companies.

Software Licenses and Copyrights

The NJ-series CPU Units and Sysmac Studio incorporate certain third party software. The license and copyright information associated with this software is available at http://www.fa.omron.co.jp/nj_info_e/.

Related Manuals

The following manuals are related. Use these manuals for reference.

Manual name	Cat. No.	Model	Application	Description
Sysmac Studio Version 1 Operation Manual	W504	SYSMAC-SE2□□□	Learning about the operating procedures and functions of the Sysmac Studio.	Describes the operating procedures of the Sysmac Studio.
Sysmac Studio Drive Functions Operation Manual	I589-E1	SYSMAC-SE2□□□	Learning about the operating procedures and functions of the Sysmac Studio for Drives	Describes the operating procedures of the Sysmac Studio to setup Drives
NJ-series CPU Unit Hardware User's Manual	W500	NJ501-□□□□ NJ301-□□□□	Learning the basic specifications of the NJ-series CPU Units, including introductory information, designing, installation, and maintenance. Mainly hardware information is provided.	Provides an introduction to the entire NJ-series system along with the following information on the CPU Unit. <ul style="list-style-type: none"> • Features and system configuration • Overview • Part names and functions • General specifications • Installation and wiring • Maintenance and inspection Use this manual together with the <i>NJ/NX-series CPU Unit Software User's Manual</i> (Cat. No. W501).
NJ/NX-series CPU Unit Software User's Manual	W501	NJ501-□□□□ NJ301-□□□□	Learning how to program and set up an NJ/NX-series CPU Unit. Mainly software information is provided.	Provides the following information on a Controller built with an NJ/NX-series CPU Unit. <ul style="list-style-type: none"> • CPU Unit operation • CPU Unit features • Initial settings • Language specifications and programming based on IEC 61131-3 Use this manual together with the <i>NJ-series CPU Unit Hardware User's Manual</i> (Cat. No. W500).
NJ/NX-series CPU Unit Motion Control User's Manual	W507	NJ501-□□□□ NJ301-□□□□ NJ101-□□□□	Learning about motion control settings and programming concepts.	Describes the settings and operation of the CPU Unit and programming concepts for motion control. When programming, use this manual together with the <i>NJ-series CPU Unit Hardware User's Manual</i> (Cat. No. W500) and <i>NJ/NX-series CPU Unit Software User's Manual</i> (Cat. No. W501).
NJ/NX-series Instructions Reference Manual	W502	NJ501-□□□□ NJ301-□□□□	Learning detailed specifications on the basic instructions of an NJ/NX-series CPU Unit.	Describes the instructions in the instruction set (IEC 61131-3 specifications). When programming, use this manual together with the <i>NJ-series CPU Unit Hardware User's Manual</i> (Cat. No. W500) and <i>NJ/NX-series CPU Unit Software User's Manual</i> (Cat. No. W501).

Manual name	Cat. No.	Model	Application	Description
NJ/NX-series Motion Control Instructions Reference Manual	W508	NJ501-□□□□ NJ301-□□□□	Learning about the specifications of the motion control instructions that are provided by OMRON.	Describes the motion control instructions. When programming, use this manual together with the <i>NJ-series CPU Unit Hardware User's Manual</i> (Cat. No. W500), <i>NJ/NX-series CPU Unit Software User's Manual</i> (Cat. No. W501), and <i>NJ/NX-series CPU Unit Motion Control User's Manual</i> (Cat. No. W507).
NJ/NX-series Troubleshooting Manual	W503	NJ501-□□□□ NJ301-□□□□	Learning about the errors that may be detected in an NJ/NX-series Controller.	Describes concepts on managing errors that may be detected in an NJ/NX-series Controller and information on individual errors. Use this manual together with the <i>NJ-series CPU Unit Hardware User's Manual</i> (Cat. No. W500) and <i>NJ/NX-series CPU Unit Software User's Manual</i> (Cat. No. W501).
1S-series AC Servomotors/Servo Drives with Built-in EtherCAT Communications User's Manual	I586	R88D-1S□-ECT R88M-1□	Learning detailed specifications of a 1S-series Servo Drive.	Describes how to install and wire the Servo Drive, set parameters needed to operate the Servo Drive, and remedies to be taken and inspection methods to be used in case that problems occur.

Revision History

A manual revision code appears as a suffix to the catalog number on the front and back covers of the manual.

Cat. No.	I827-E1-01
-----------------	-------------------

↑
Revision code

Revision code	Date	Revised content
01	April 2017	Original production

CONTENTS

Introduction	3
Intended Audience	3
Applicable Products	3
Special Information	3
Terms and Conditions Agreement	4
Precautions	6
Trademarks	6
Software Licenses and Copyrights	6
Related Manuals	7
Revision History	9
1. Servo system configuration and peripheral products	11
1.1. Outline	11
1.2. Servo System constructed in this guide.....	12
2. Before You Begin	14
2.1. Installing the Sysmac Studio.....	14
2.2. Assembling the Hardware	15
2.3. Wiring the Devices	16
3. Performing setup	20
3.1. Two axis servo system operation.....	20
3.2. System setup procedures	22
3.3. Creating project with Auto connection	22
3.4. Creating the EtherCAT Network Configuration.....	24
3.5. Creating motion axes	26
3.6. Program making and transfer to the CPU Unit.....	32
3.7. Drives and motors parameters setup.....	34
3.8. Easy Tuning (Multiple Drives)	38
ANNEX	44
A-1 Settings when control input signals are not wired	44
A-2 Program making with structured text	51

1. Servo system configuration and peripheral products

1.1. Outline

The 1S-series AC Servo Drives with Built-in EtherCAT communications support 100-Mbps EtherCAT. When you use the 1S-series Servo Drive with a Machine Automation Controller NJ/NX-series CPU Unit, you can construct a high-speed and sophisticated positioning control system.

Also, you need only one communications cable to connect the Servo Drive and the Controller. Therefore, you can realize a position control system easily with reduced wiring effort.

With auto tuning, adaptive filter, notch filter, and damping control, you can set up a system that provides stable operation by suppressing vibration in low-rigidity machines.

For machine composed with multiple 1S-series AC Servo Drives, Sysmac Studio provides a set of functions to set-up and tune parameters with less effort.



Additional Information

For additional information about 1S servo drive, please refer to 1S-series AC Servomotors and Servo Drives User's Manual (with Built-in EtherCAT Communications) (Cat. No. I586)

1.2. Servo System constructed in this guide

This 1S-series Startup Guide for multi-axis setup and tuning (hereafter referred to as “this Guide”) contains instructions to set-up and tune an X-Y stage system composed of two 1S-series AC Servo Drives.

The following figure shows the system configuration and devices that are used in this Guide.

The system configuration is shown in the following figure.

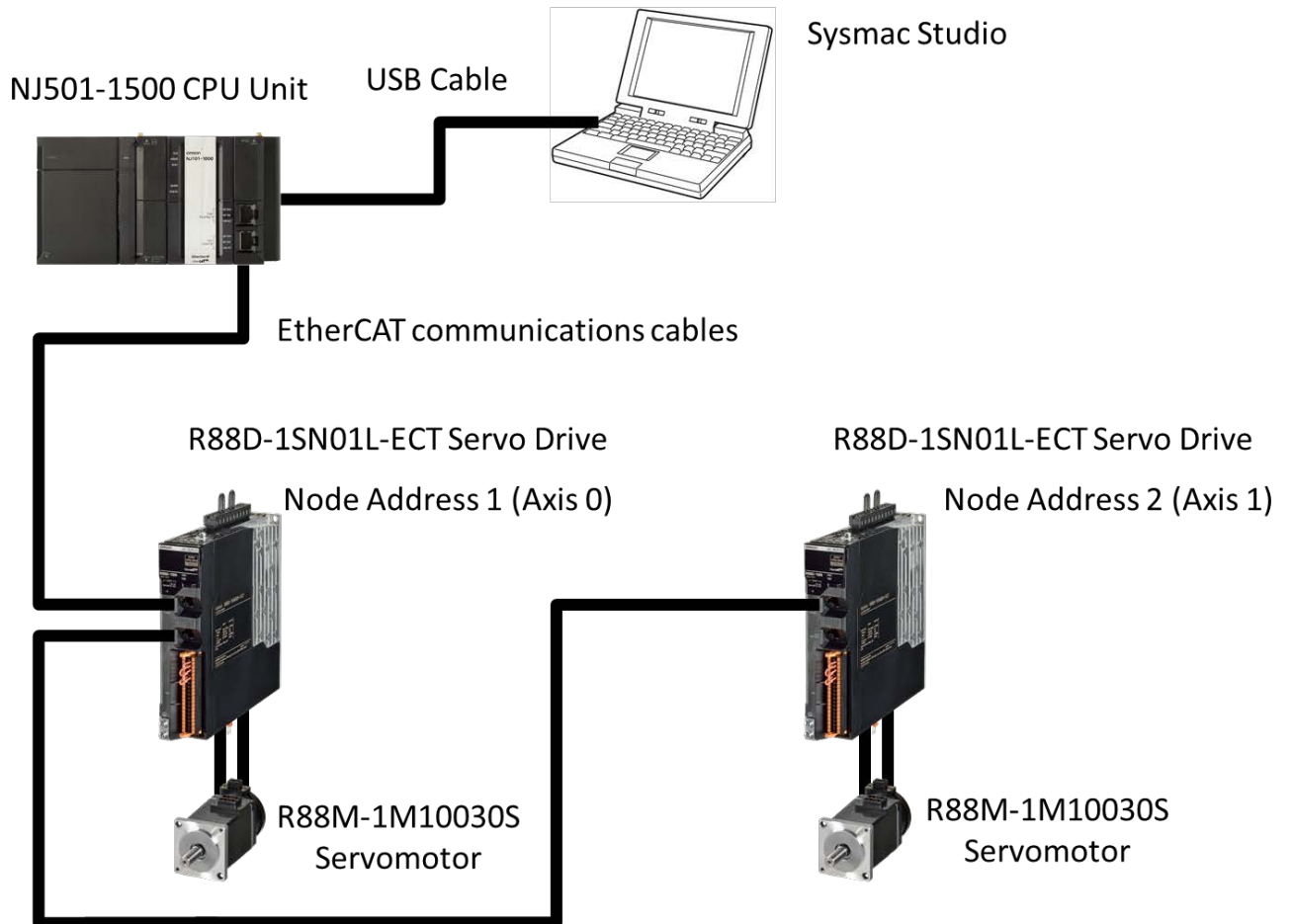

- **Configuration devices**

The models of the devices that are described in this Guide are given in the following table. When selecting devices for an actual application, refer to the device manuals.

Device name	Model	Manual name
NJ-series CPU Unit	NJ501-1500	NJ-series CPU Unit Hardware User's Manual (Cat. No. W500)
NJ-series Power Supply Unit	NJ-PA3001	
EtherCAT communications cables	XS5W-T421-CMD-K	
AC Servo Drives	R88D-1SN01L-ECT	1S-series AC Servomotors and Servo Drives User's Manual (with Built-in EtherCAT Communications) (Cat. No. I586)
AC Servo Motors	R88M-1M10030S	
Power cables	R88A-CA1A003S	
Encoder Cables	R88A-CR1A003C	

- **Automation software**

Product	Number of license	Model
Sysmac Studio Standard Edition Version 1.18 or higher	None (DVD only)	SYSMAC-SE200D
	1 license	SYSMAC-SE201L

2. Before You Begin

2.1. Installing the Sysmac Studio

The Sysmac Studio is the Support Software that you use for an NJ-series Controller. On it, you can set-up the Controller configurations, parameters, and programs, and you can debug and simulate operation.

Install the Sysmac Studio on your computer.

Refer to the *NJ-series Startup Guide for CPU Units* (Cat. No. W513) for the procedure to install the Sysmac Studio.



2.2. Assembling the Hardware

This section describes how to assemble the hardware used in the system.

This section gives an overview of the assembly procedures. Refer to the manuals for the devices that are used in the system for detailed assembly procedures and safety precautions.



Precautions for Safe Use

Always turn OFF the power supply to the Controller and to the Servo Drives before you attempt any of the following.

- Mounting or removing the CPU Unit and Other Units
- Assembling Racks
- Setting DIP switches or rotary switches.
- Connecting cables or wiring the system
- Connecting or disconnecting the connectors

The Power Supply Unit continues to supply power to the Controller for up to several seconds after the power supply is turned OFF. The PWR indicator remains lit as long as power is supplied. Make sure that the PWR indicator is not lit before you perform any of the above operations.

Mounting the Units

Connect the Power Supply Unit, CPU Unit, and End Cover.

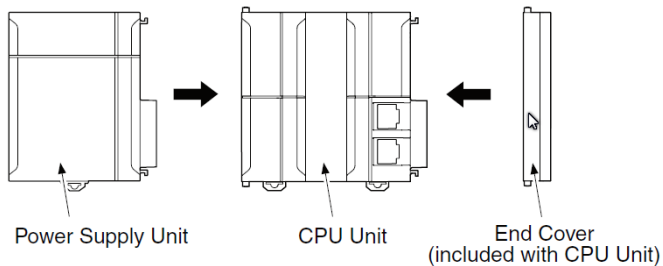

After joining the connectors between the Units, use the sliders at the top and bottom of each Unit to lock the Units together. Lock the sliders firmly into place.

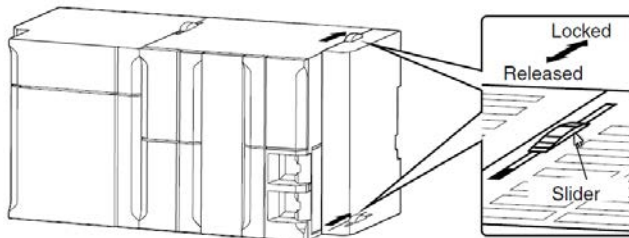

2.3. Wiring the Devices

This section describes how to wire the hardware devices.

This section gives an overview of the wiring procedures. Refer to the manuals for the devices that are used in the system for detailed wiring procedures and safety precautions.

Wiring the Rack Power Supply Unit

Wire the Power Supply Unit to the power supply.

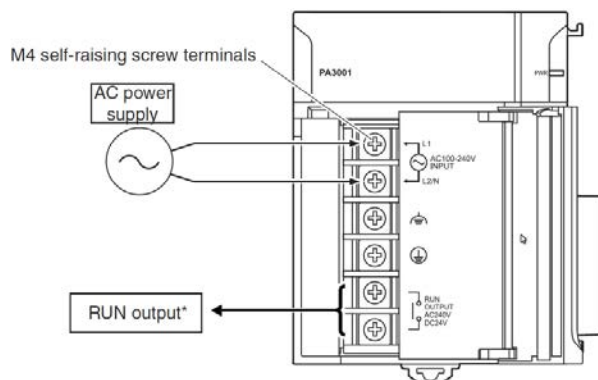

*The RUN output is ON when the CPU Unit is in RUN mode. It is OFF when the CPU Unit is in PROGRAM mode or when a major fault level Controller error occurs.



Additional Information

This Guide uses an NJ-PA3001 AC Power Supply Unit. An NJ-PD3001 DC Power Supply Unit can also be used.

Wiring the Servo Drive Power Supply

Wire the Servo Drives to the power supply as shown in the following figure.

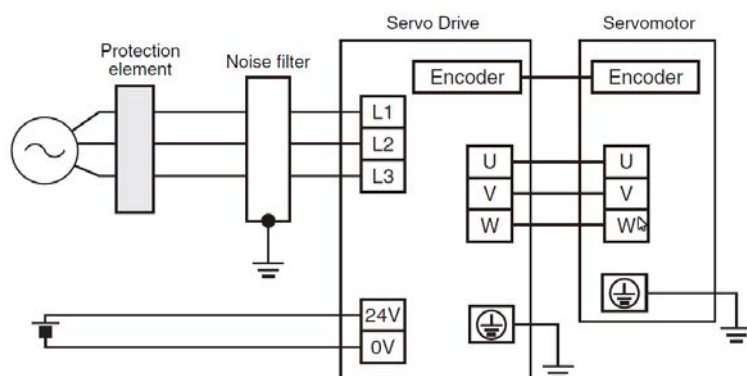

Additional Information

For further details about wiring method, please refer to 1S-series AC Servomotors and Servo Drives User's Manual (with Built-in EtherCAT Communications) (Cat. No. I586)

Laying EtherCAT Communications Cables

Connect the EtherCAT slave communications cables between the built-in EtherCAT port on the CPU Unit and the EtherCAT slaves as shown in the following figure.

Connect the communications cable from the built-in EtherCAT port to the input port on the first slave, and then connect the communications cable to the next slave to the output port on the first slave.

Do not connect anything to the output port of the slave at the end of the network.

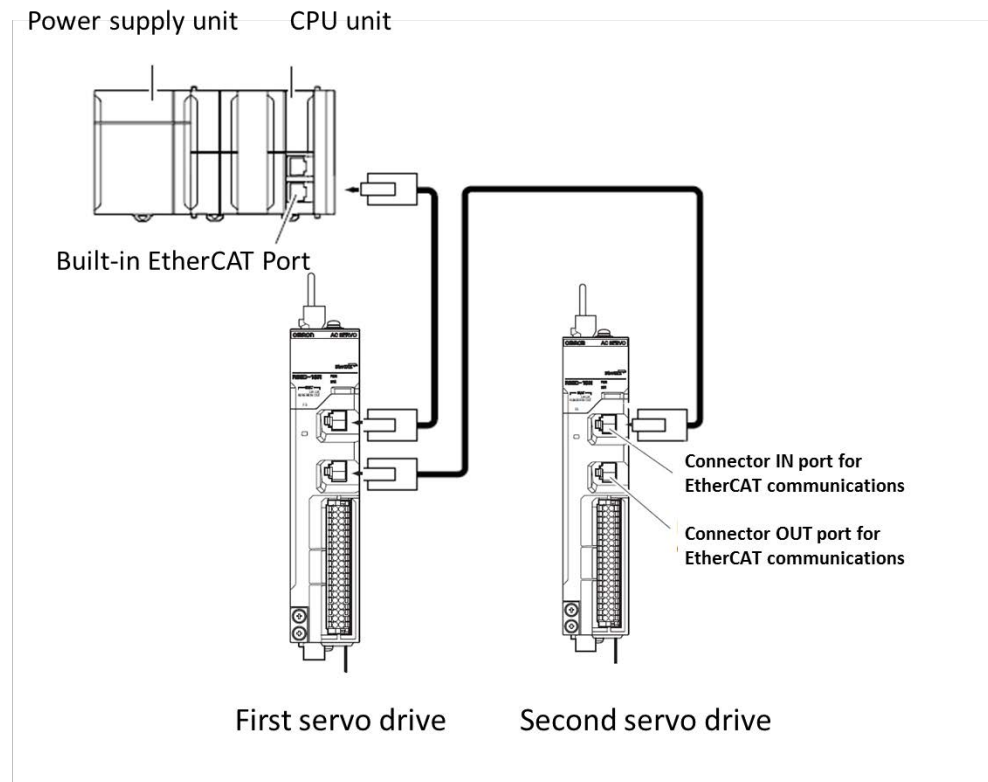

Setting the Node Addresses of the Servo Drives

Set the node addresses of the Servo Drives as shown below.

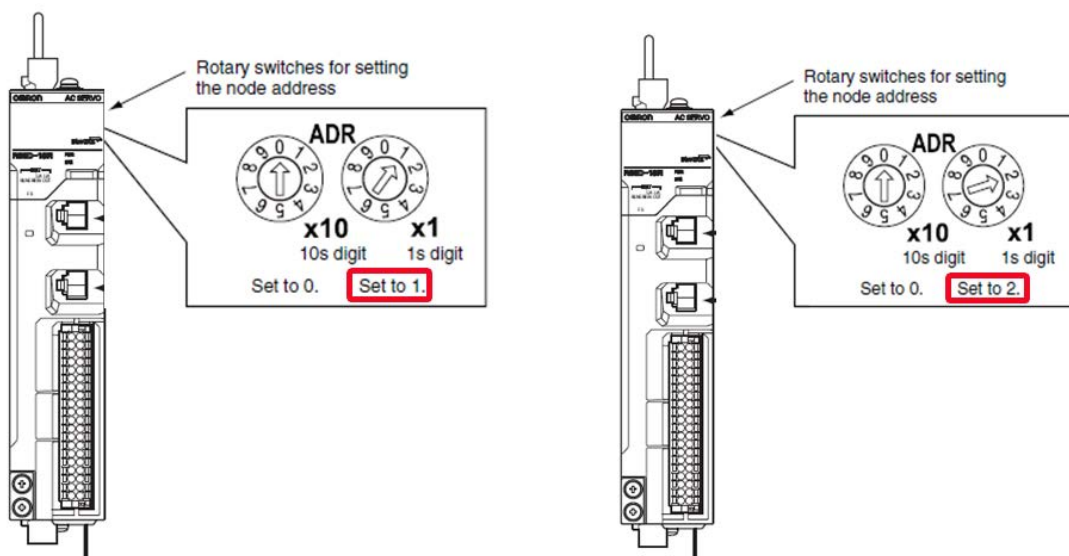

Wiring the Servo Drives and the Servomotors

Wire the Servo Drives and the Servomotors as shown in the following figure.

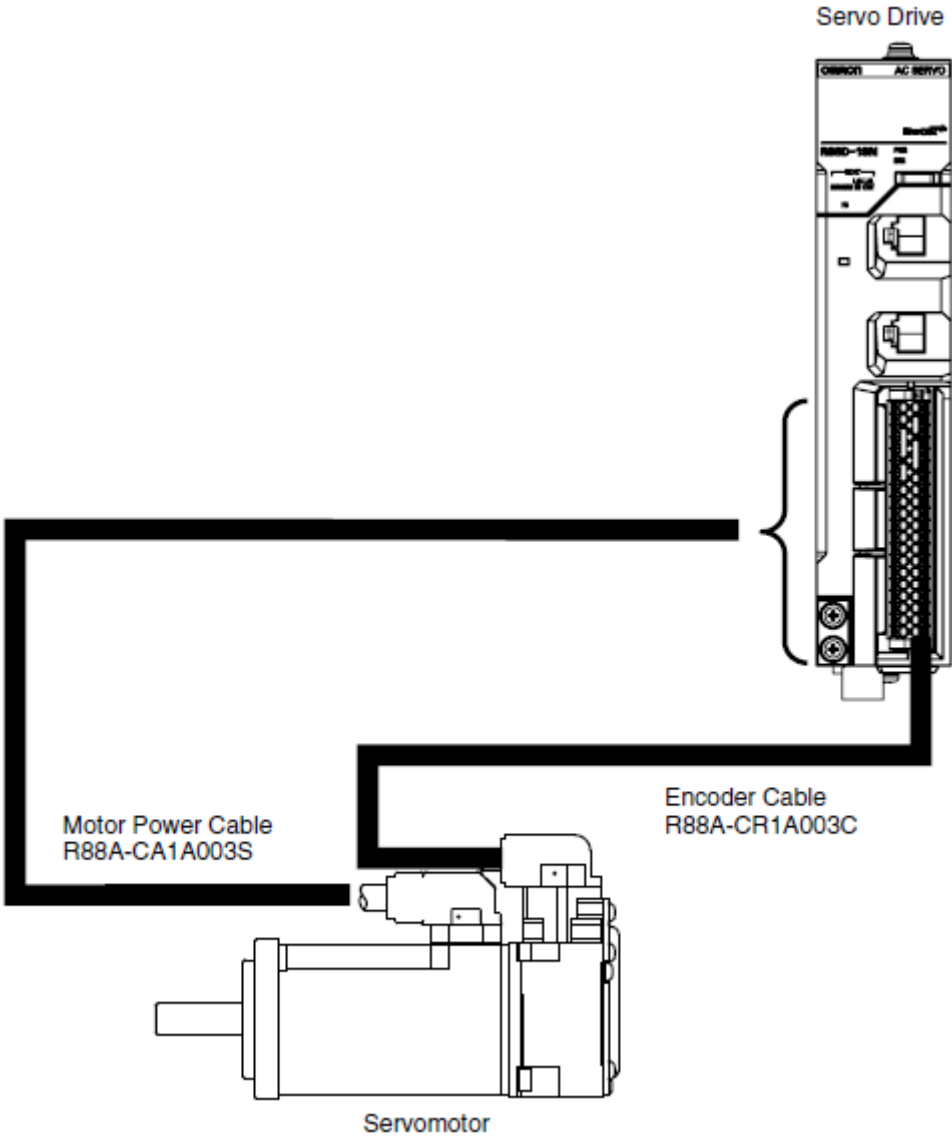

Wiring the Control Input Signals for the Servo Drives

Wire the control input signals for the Servo Drive using the R88A-CN101C Control I/O connector (CN1).

For details on wiring, refer to the AC Servomotors/Servo Drives 1S-series with Built-in EtherCAT Communications User's Manual (Cat. No. I586).

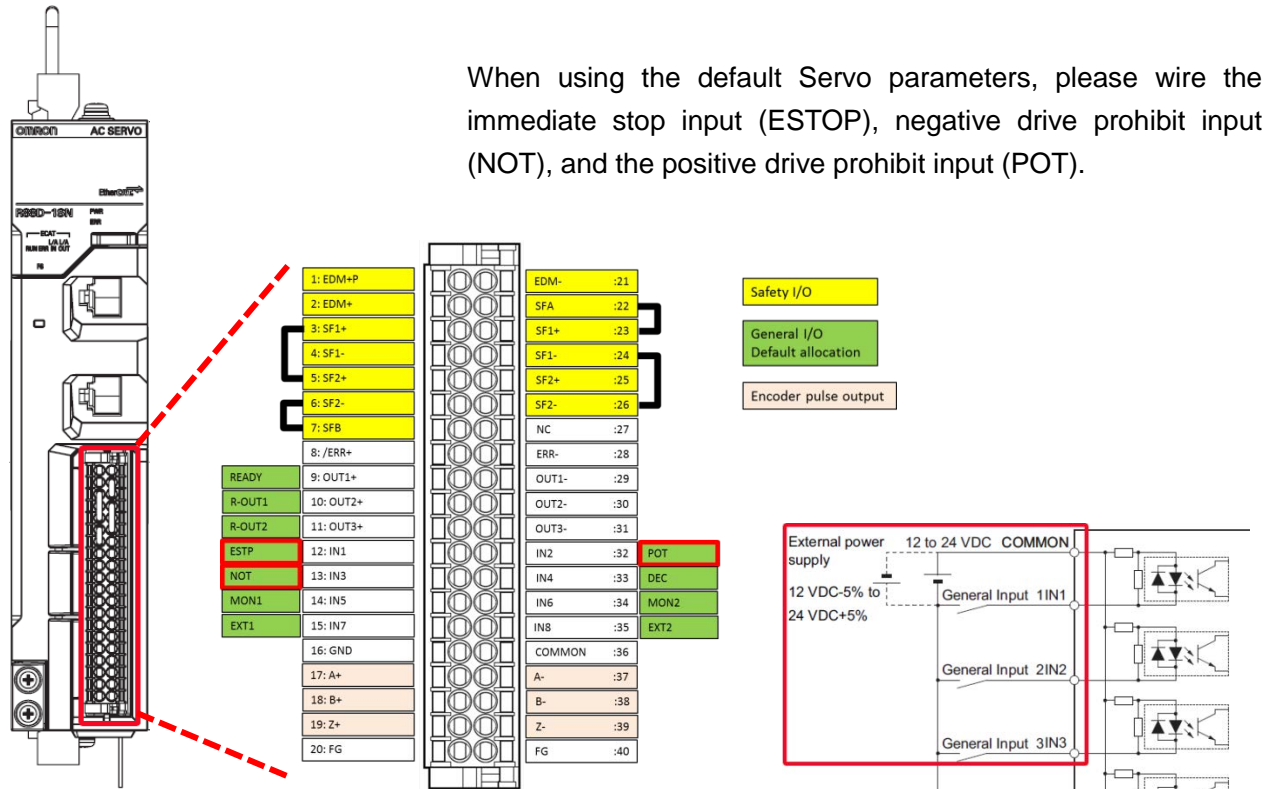

*Control I/O Connector (CN1):

Used for command input signals, I/O signals, and as the safety device connector. The short-circuit wire is installed on the safety signals before shipment.



Additional Information

- If you use the default Servo parameters, you must wire the immediate stop input, negative drive prohibit input, and the positive drive prohibit input.

If these inputs are not wired, the CPU Unit will remain in the drive prohibit signal and emergency stop signal detected state, and a minor fault level Controller error will occur. The minor fault level Controller errors that will occur are an Immediate Stop Input Error and a Drive Prohibition Input Error. (The event codes are 68220000 and 64E30000.)

- If the above signals are temporarily not wired while commissioning the system, you can temporarily change the Servo parameters to prevent these errors from occurring in the CPU Unit.

Refer to [A-1 Settings When Control Input Signals Are Not Wired](#) for details on the settings that you must change in this case.

3. Performing setup

3.1. Two axis servo system operation

This section describes the operation of two-axis Servo system that is set up in this Guide. In this system, axis 0 and axis 1 are set up for an XY stage.

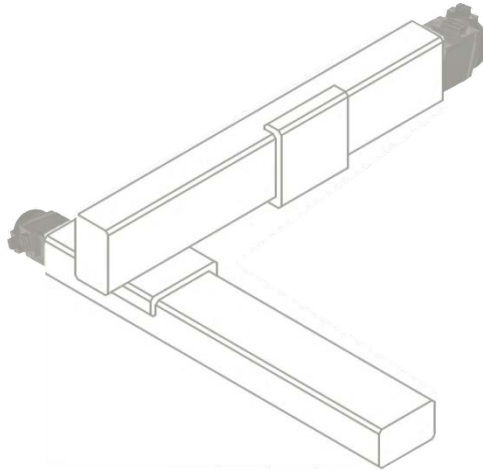

The mechanical configuration of axis 0 and axis 1 are as shown in the following table.

Item	Axis 0 / Axis 1 mechanical configuration
Motor rated speed	3000 r/min
Ball screw pitch	10 mm
Encoder resolution	23 bits/rotation (8,338,608)

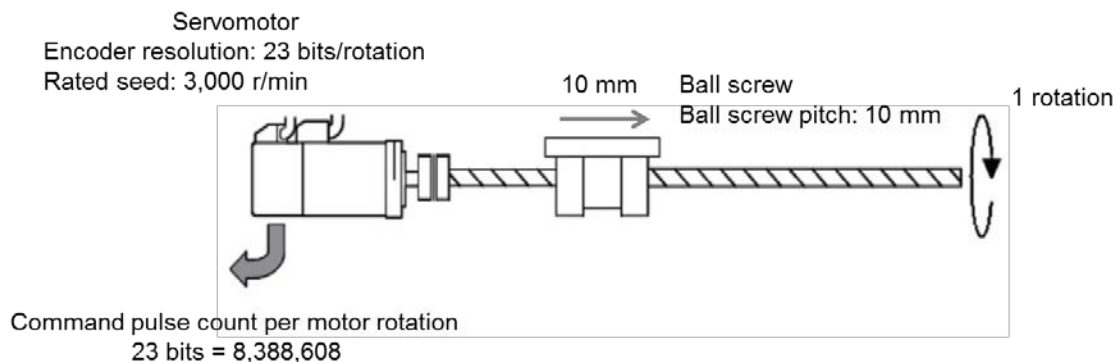

The XY stage will repeatedly travel between two points using linear interpolation with a 2 seconds dwell time after each movement.

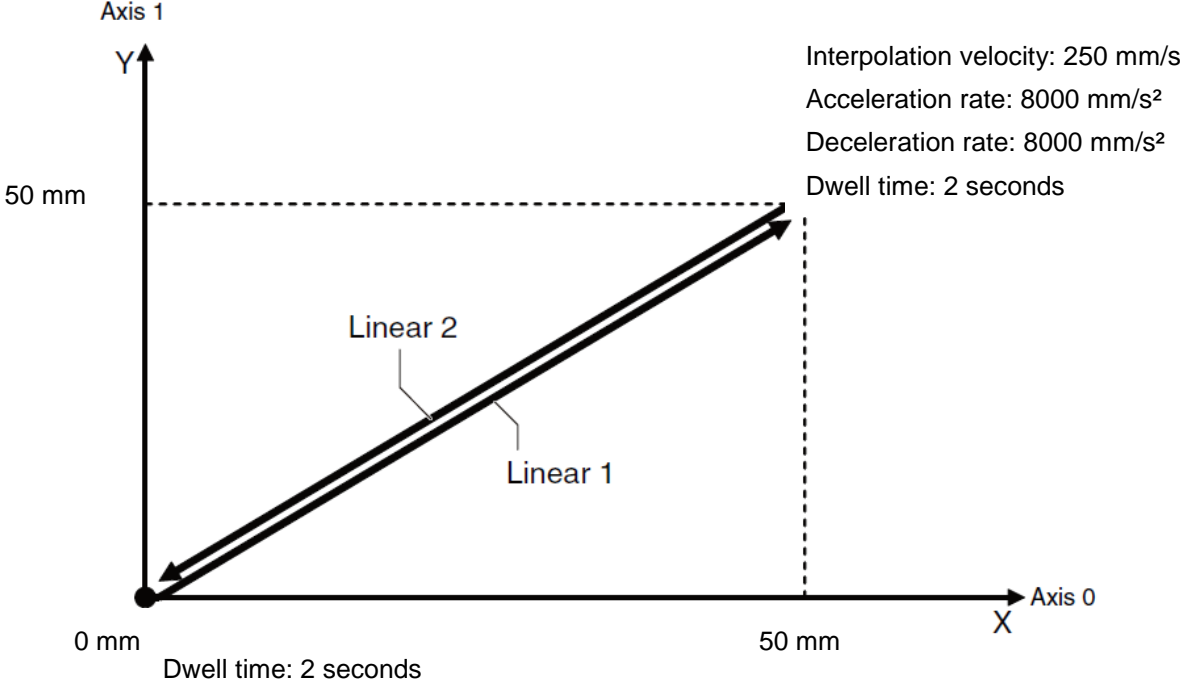

The speed waveforms for axis 0 and axis 1 are shown below

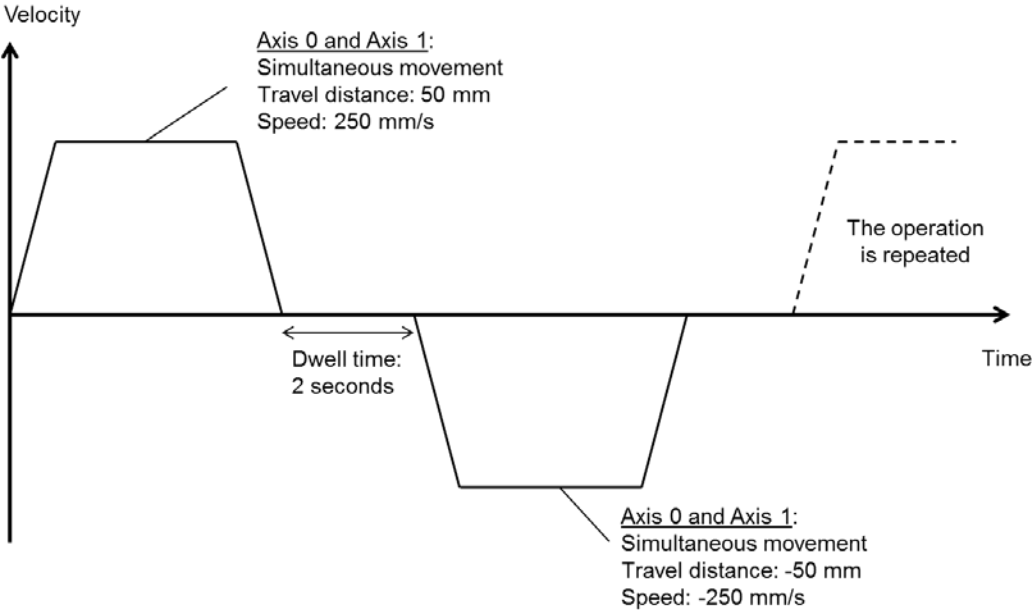

3.2. System setup procedures



- 1 [Create a project with Auto connection](#)
- 2 [Create the EtherCAT Network configuration](#)
- 3 [Create motion axes](#)
- 4 [Program making and transfer to the CPU Unit](#)
- 5 [Drives and motors setup](#)
- 6 [Multiple drive Easy tuning for gain adjustment](#)

3.3. Creating project with Auto connection

Start the Sysmac Studio:

Select **All Programs – OMRON – Sysmac Studio – Sysmac Studio** from the Windows Start Menu.

Create a project in the Sysmac Studio

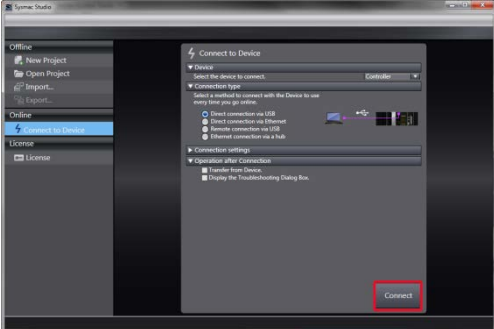
1.	<p>Click the  Button in the Project window</p> 
2.	<p>In the Connect to Device Dialog Box,</p> <p>Click the  button</p> 

Sysmac Studio will browse and connect to the controller

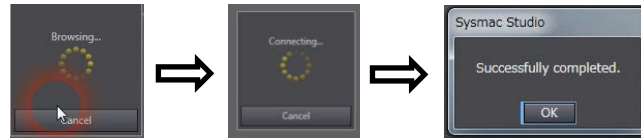

This concludes the procedure to create a project file with auto connection

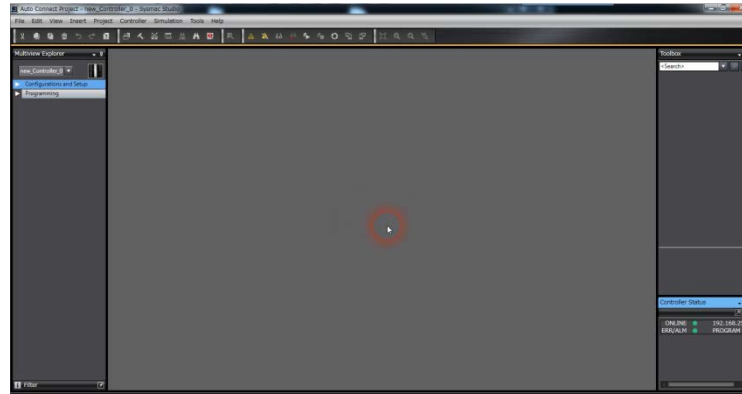

Additional Information

For creating a project offline or specific procedures please refer to the Sysmac Studio Version 1 Operation Manual (Cat. No. W504).

3.4 Creating the EtherCAT Network Configuration

Two R88D-1SN01L-ECT Servo Drives are registered in the EtherCAT network configuration

1. Double-click **EtherCAT** under **Configurations and Setups** in the Multiview Explorer.

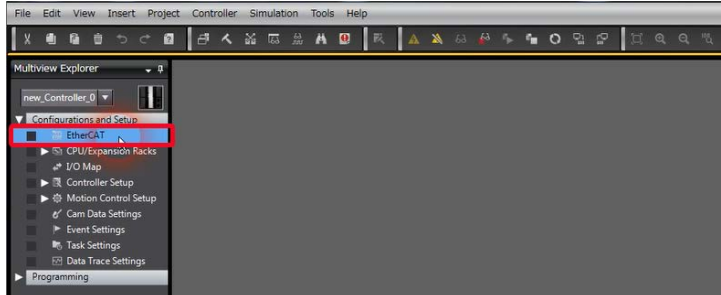

The EtherCAT page is displayed in the Edit Pane.

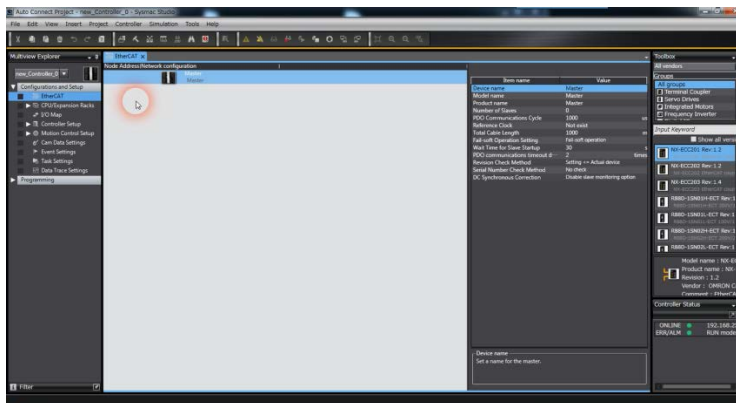

2. Right click on the **Master** and select **Compare and Merge with Actual Network Configuration**

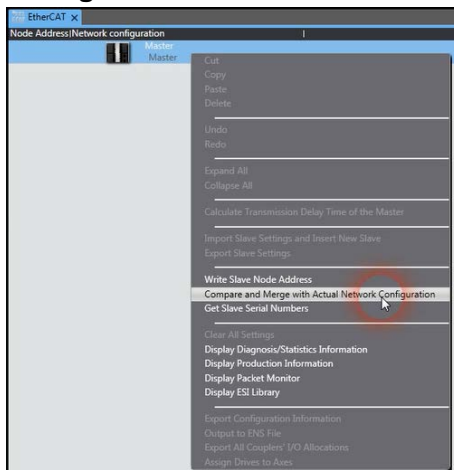

3. The Compare and Merge with Actual Network Configuration window is displayed
Click on **Apply actual network configuration** to apply the actual network configuration.

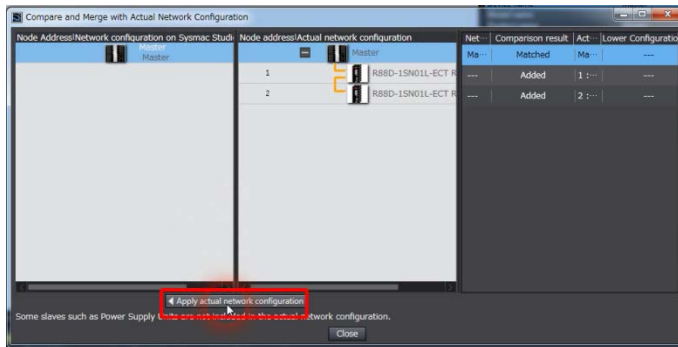

Click **Apply** to confirm:

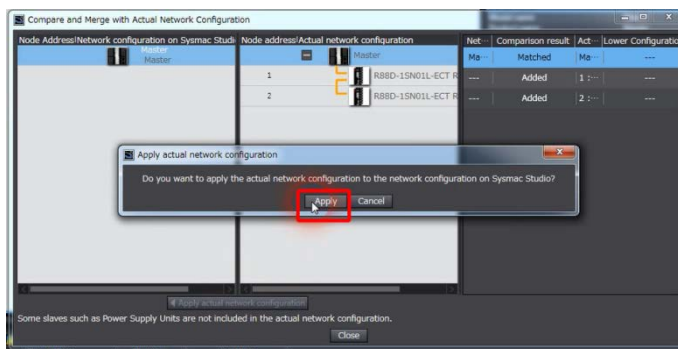

A pop-up message confirmed the network configuration.

Click the **Close** Button

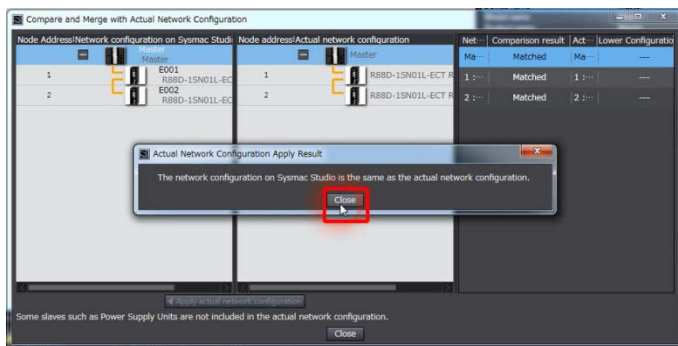

Confirm the detected configuration and close the window

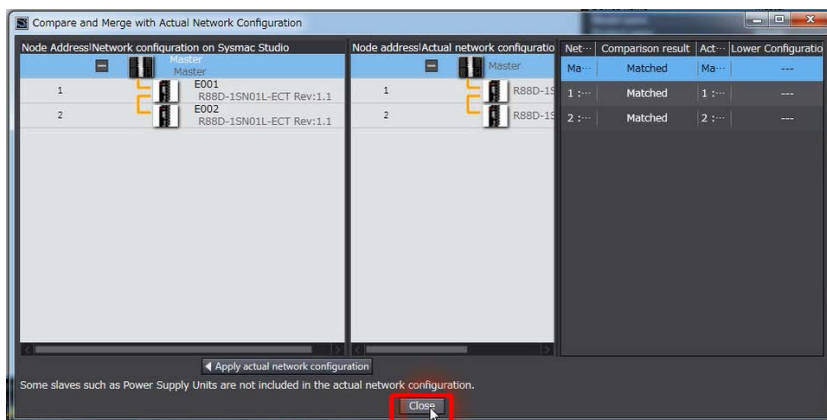

Disconnect from the controller

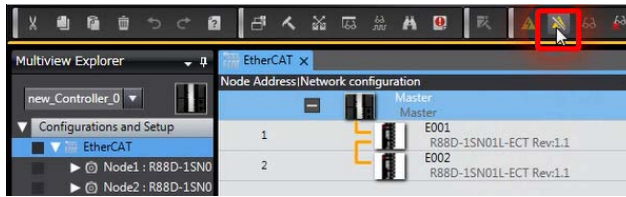

3.5 Creating motion axes

This section describes how to add axes used to control Servo Drives. Axes will be created based on detected Servo Drives.

1. Right click on the **Master** and select **Assign Drives to Axes**

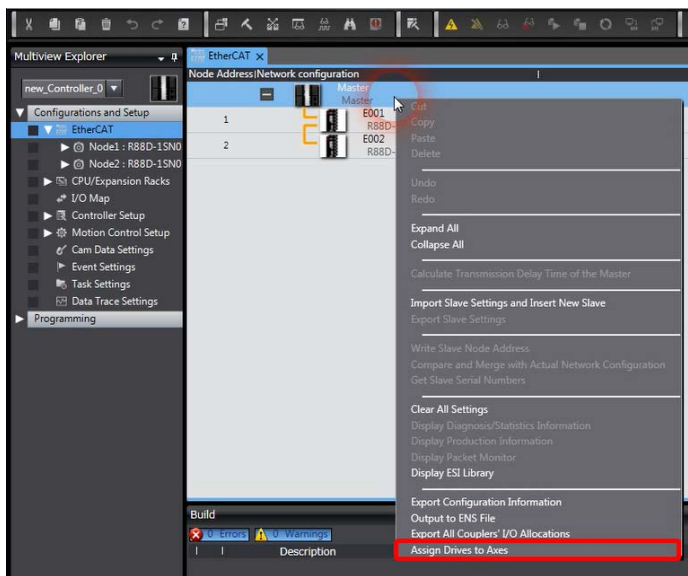

Confirm axes allocation by clicking the **Yes** Button

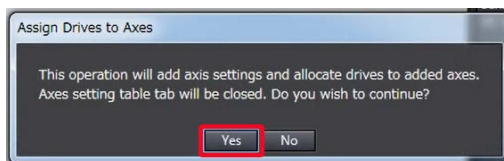

Confirm the list of Axes added and Click the **Ok** Button

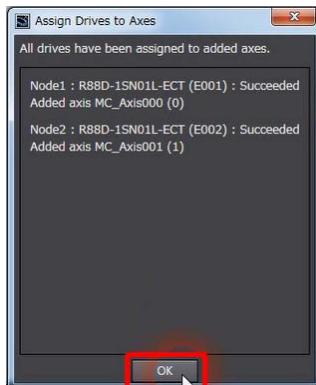

Right-click **Axis Settings** in the Multiview Explorer and select **Axis setting table**.

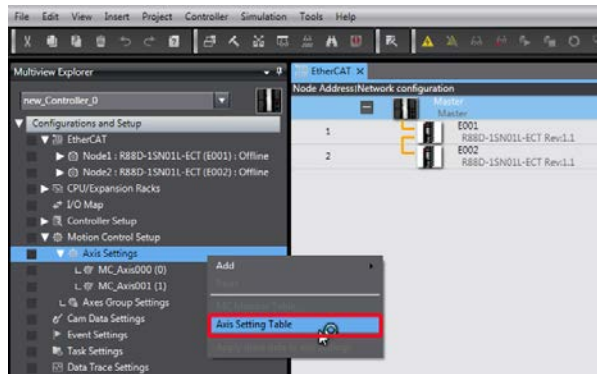

Axis number has been set to 0 and 1, **Axis type** to Servo axis and **Output device 1** to Node: 1 and Node: 2 on CH1 (Channel 1).

Axis Name	1 MC_Axis000	2 MC_Axis001
Axis Basic Settings		
Axis number	0	1
Axis use	Used axis	Used axis
Axis type	Servo axis	Servo axis
Feedback control	No control loop	No control loop
Input device 1	-	-
Channel	-	-
Input device 2	-	-
Channel	-	-
Input device 3	-	-
Channel	-	-
Output device 1	Node: 1	Node: 2
Channel	CH1	CH1
Output device 2	-	-
Channel	-	-
Output device 3	-	-
Channel	-	-

Project transfer to synchronize Sysmac Studio project and the CPU unit

2. Click the **Connect Button** on the Toolbar



Click the **Transfer to Controller** Button on the Toolbar

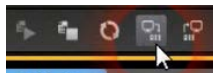

Click the **Execute** Button to transfer the project from the computer to the CPU unit

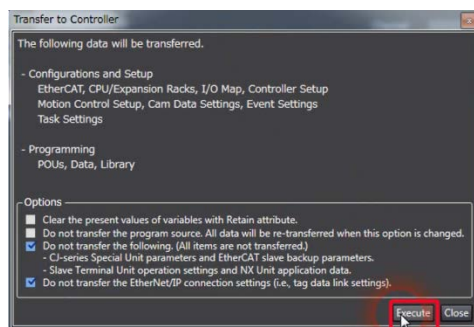

Click the **Yes** Button

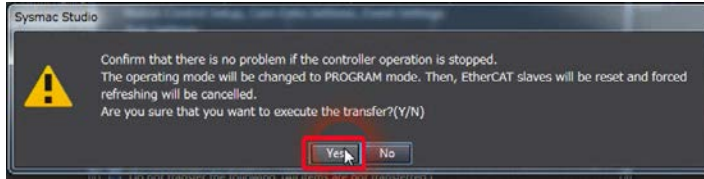

The operating mode changes to PROGRAM mode, and the Sysmac Studio starts transferring the project to the CPU Unit. During the transfer, a progress bar appears in the Synchronize Pane.



After download completion, Click The Yes Button to switch to RUN mode.

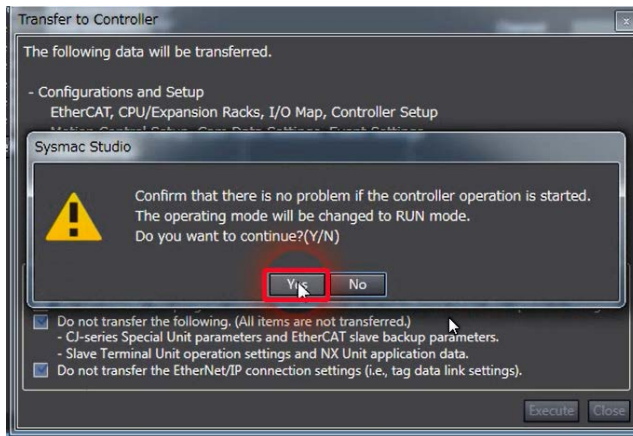

The transfer is completed, Click the Ok Button



Apply Drive/Motor data to axis via network reading

3. Right-click **Axis Settings** in the Multiview Explorer and select **Apply drive data to axis settings**.

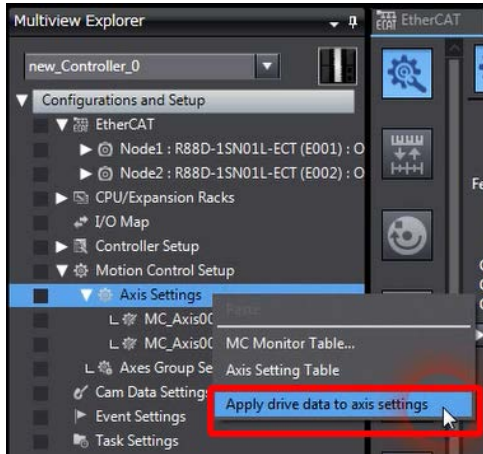

Click the **Yes** Button to acquire data from the servo drive via EtherCAT Network

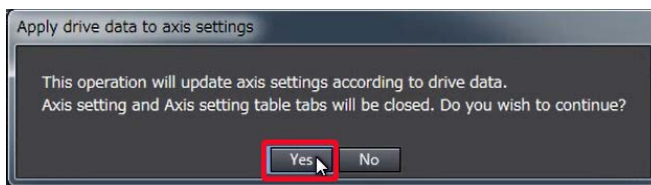

Applied axis settings are based on drive and motor data:

Command pulse count per motor rotation is set to 8,388,608 following the 23 bits resolution of the motor.

Maximum velocity and **Maximum jog velocity** are set based on rated speed of the motor.

Maximum positive torque limit and **Maximum negative torque limit** are set based on drive/motor maximum torque limit.

Encoder type is set to Absolute encoder.

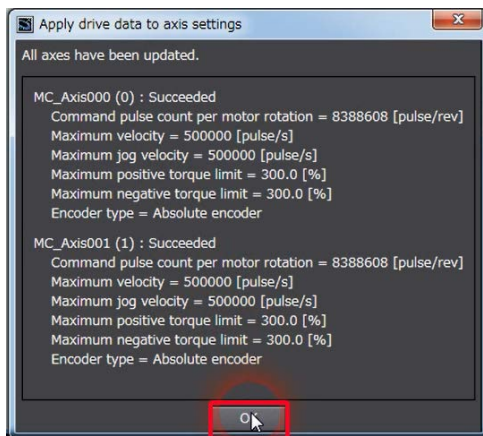

After confirmation, Click the **Ok** Button.

Modification of axis settings to match the XY stage System

3. Disconnect from the Controller

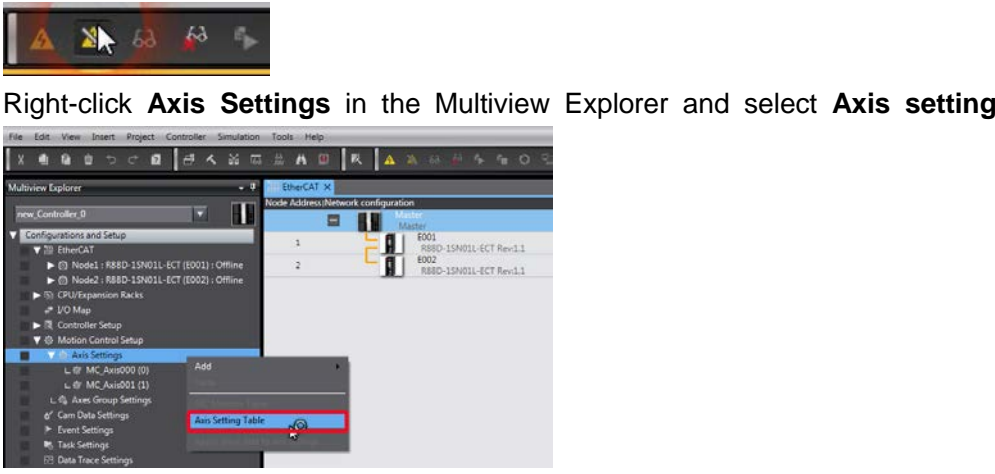

Right-click **Axis Settings** in the Multiview Explorer and select **Axis setting table**.

Edit axis settings according to the XY stage ball screw system

Axis Name	1 MC_Axis000	2 MC_Axis001
Unit Conversion Settings		
Unit of display	mm	mm
Command pulse count per motor rotation	8388608 pulse/rev	8388608 pulse/rev
Gearbox usage	Do not use gearbox	Do not use gearbox
Work travel distance per motor rotation	10 mm/rev	10 mm/rev
Work travel distance per work rotation	10000 mm/rev	10000 mm/rev
Work gear ratio (Numerator of the reduction ratio)	1	1
Motor gear ratio (Denominator of the reduction ratio)	1	1
Operation Settings		
Maximum velocity	500 mm/s	500 mm/s
Velocity warning value	0 %	0 %
Start velocity	0 mm/s	0 mm/s
Maximum jog velocity	100 mm/s	100 mm/s

Note: Alternatively, Unit conversion settings can also be modified before transferring the project; in that case operation settings will be scaled based on mm units and drive data.

Adding Axes Group Settings

4. Right-click **Axes Group Settings** under **Configurations and Setup - Motion Control Setup** in the **Multiview Explorer** and select **Add - Axes Group Settings** from the menu.

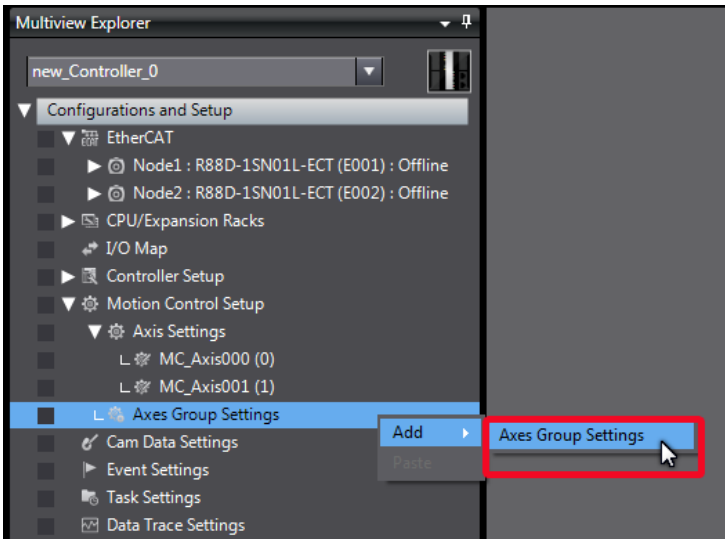

An axes group is added to the Multiview Explorer.
The new axes group is displayed as **MC_Group000**.

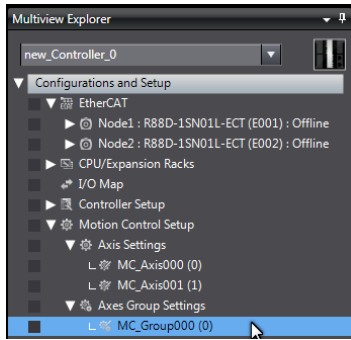

Right-click the group that you added in the Multiview Explorer and select **Edit** from the menu.

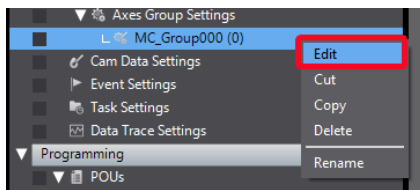

The axes group settings are displayed on the Axes Group Basic Settings Display in the Edit Pane.

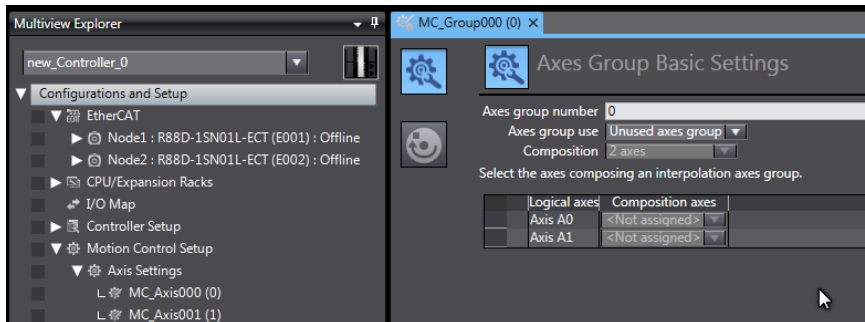

Set the Axes Group Basic Settings for axes group 0 as shown in the following figure.

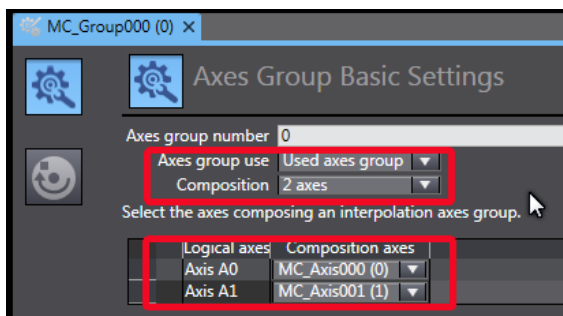

This concludes the axes group settings.

3.6 Program making and transfer to the CPU Unit

Create the instructions to perform linear interpolation of two axes.

The following instructions are created. To do so, we will use axis variables, an axes group, and motion control instructions.

Rung 0: Axes Servo ON

Rung 1: Axes homing to zero position preset

Rung 2: Axis group enable

Rung 3: Absolute position assigned to input variables

Rung 4: Movement cycle (50mm>2sec>50mm>2sec repeating)

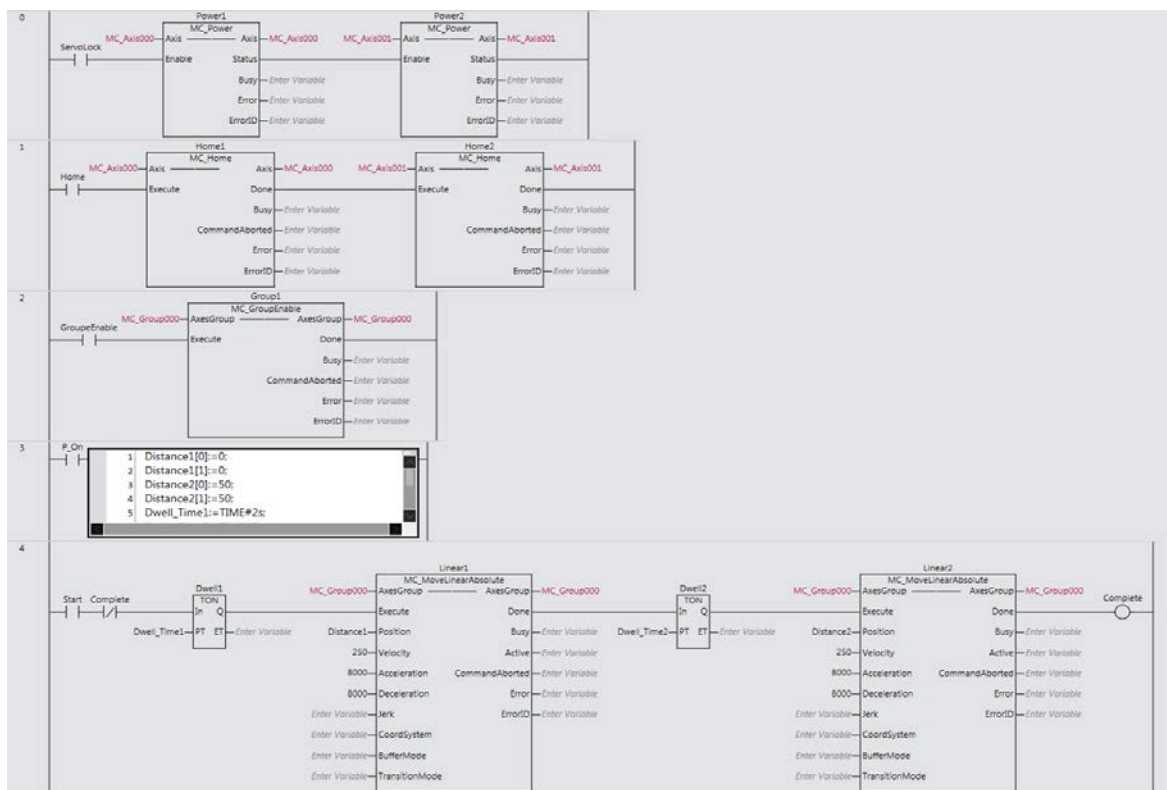

Please refer to [A-2 Appendix](#) for the equivalent Structured Text program example





Refer to the *NJ/NX-series Startup Guide for CPU Units* (Cat. No. W513) for details on how to create ladder diagrams.

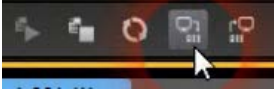
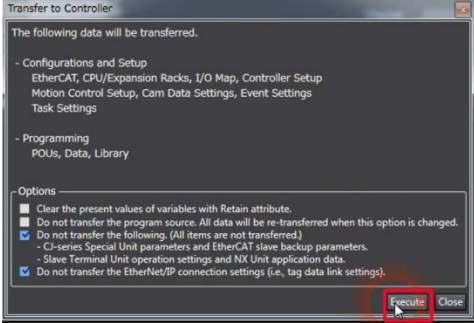

Precautions for Correct Use

The sample programming that is provided in this Guide includes only the programming that is required to operate the Servomotors. When programming actual applications, also program EtherCAT communications, device interlocks, I/O with other devices, and other control procedures.

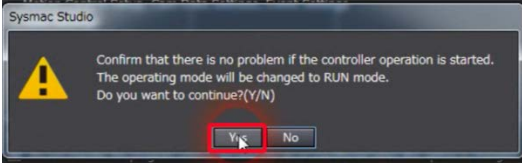
Transfer to the CPU Unit

1.	<p>Click the Connect Button on the Toolbar</p> 
2.	<p>Click the Transfer to Controller Button on the Toolbar</p> 
3.	<p>Click the Execute Button to transfer the project from the computer to the CPU unit</p>  <p>Click the Yes Button</p>  <p>The operating mode changes to PROGRAM mode, and the Sysmac Studio starts transferring the project to the CPU Unit. During the transfer, a progress bar appears in the Synchronize Pane.</p>  <p>After download completion, Click The Yes Button to switch to RUN mode.</p>  <p>The transfer is completed, Click the Ok Button</p> 

3.7 Drives and motors parameters setup

This section explains the procedure to setup parameters of drives and motors.

The absolute encoder must be set up the first time it is used, and when the rotation data is initialized to 0.

1. Right-click the Servo Drive and select **Setup and Tuning** from the menu.

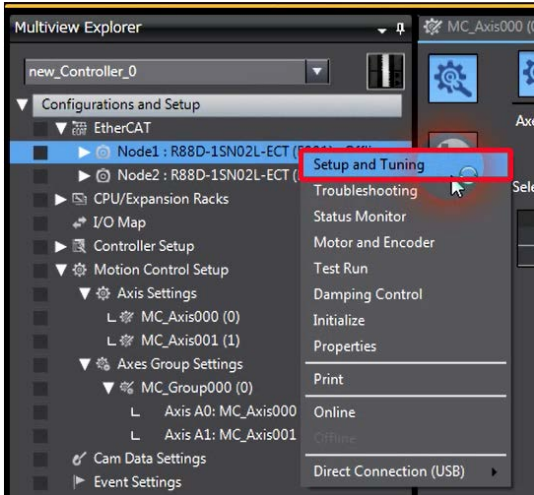

The Setup and Tuning Portal appears.

2. Click the **Quick Parameter Setup and I/O Monitor** Button.

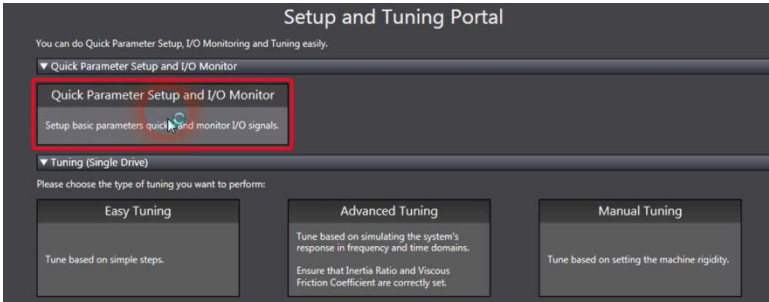

The following dialog box appears. Click the **Yes** Button.

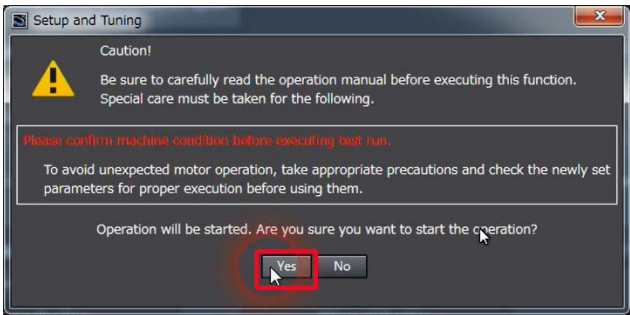

The Motor and Encoder setting Page appears.

3. Click the **Launch Motor and Encoder view** Button.

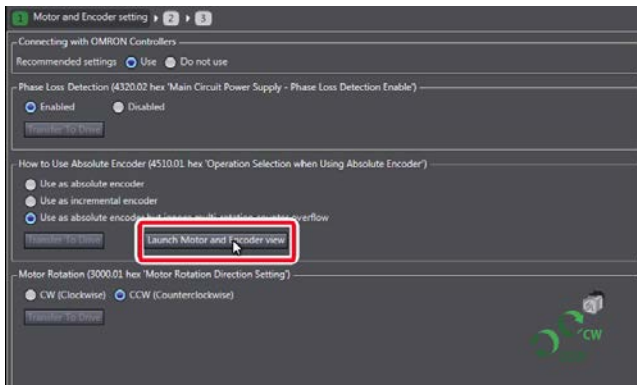

The Encoder Properties Tab Page appears.

4. Click the **Clear system** Button.

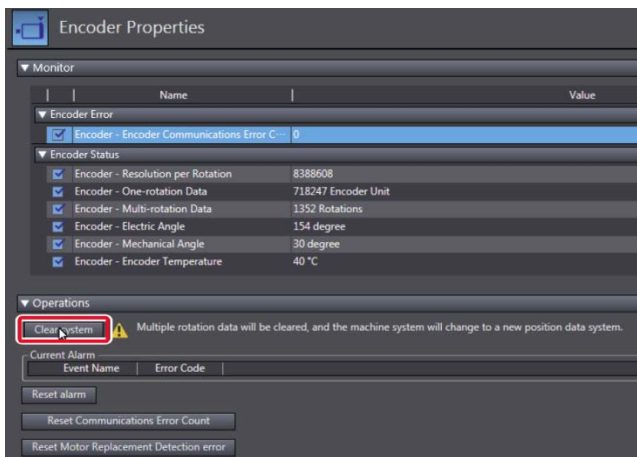

An Absolute Value Clear Error (error display number: 2701) will occur, and a dialog box indicating "Restart the drive to complete the operation."

5. Click the **Yes** Button.

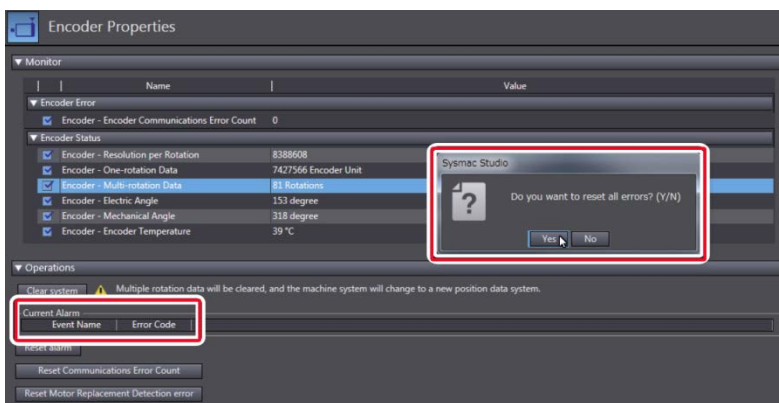

The multiple rotation data of the absolute encoder is cleared.
Return to the Wizard window.

Check the motor rotation direction and modify settings if required

6. Adjust the motor rotation direction and transfer to the drive

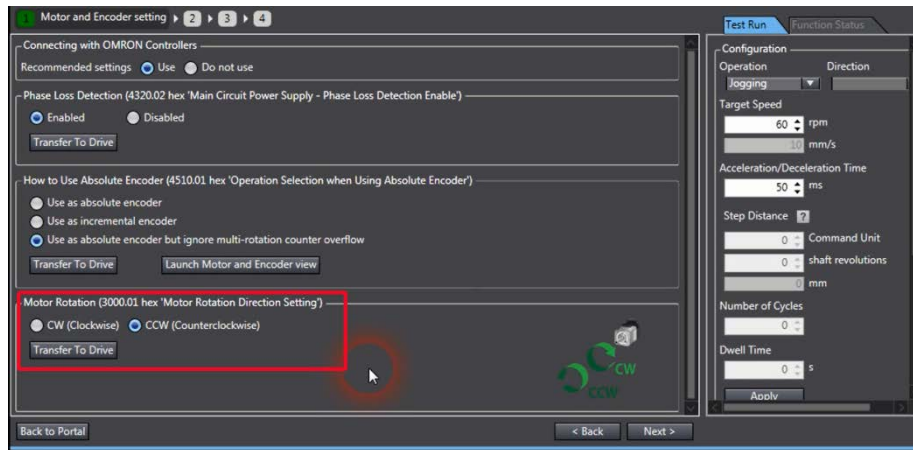

7. Validate the motor operation

Apply the test run configuration, activate the Servo ON and initiate the movement

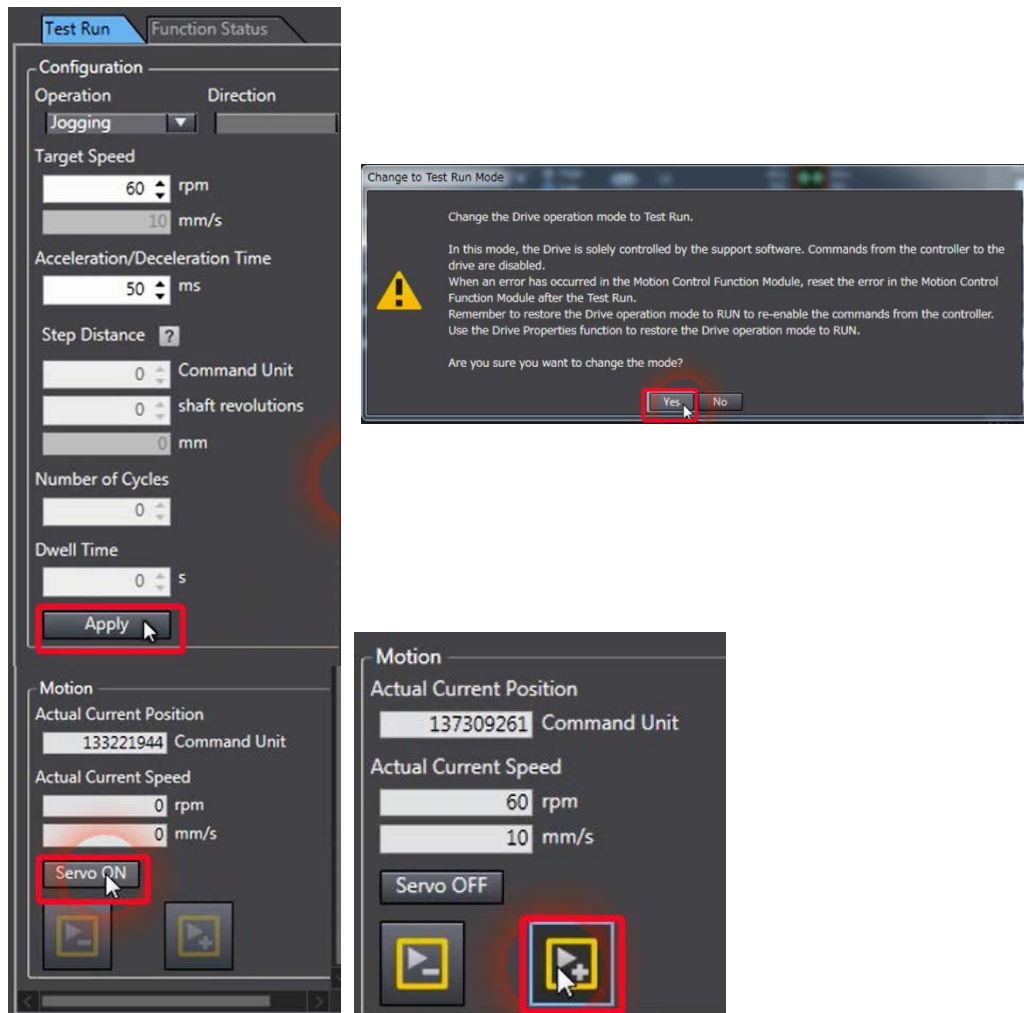

Note: In case of Error 87.00 ESTP input, please check your wiring connection or disable the error stop input (IN1) as explained in [A-1 Settings When Control Input Signals Are Not Wired](#) for details on the settings that you must change in this case.

8. Click the **Back to Portal** Button

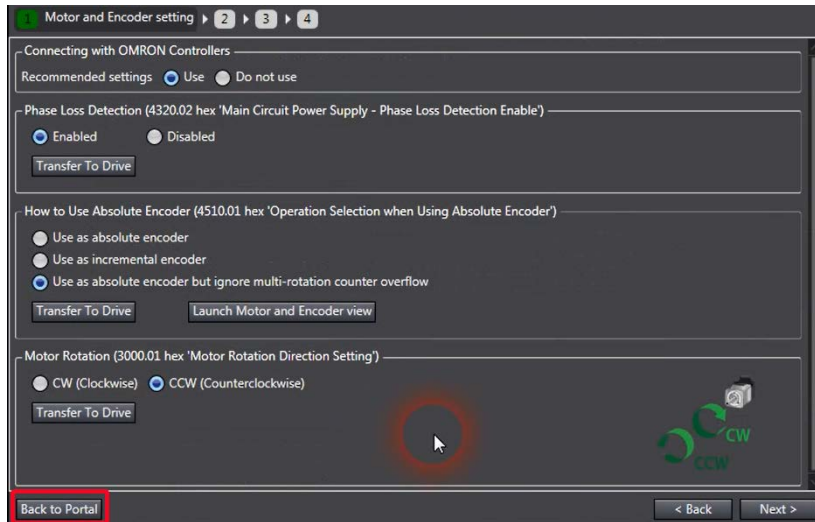

9. Please repeat the same operation for the node 2.

10. Following above procedure, drives have been restarted to apply Input settings. Please Reset the EtherCAT Slave Communication Error in the CPU Unit with Troubleshooting window.

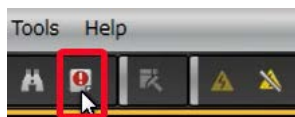

Click on **Reset All** button

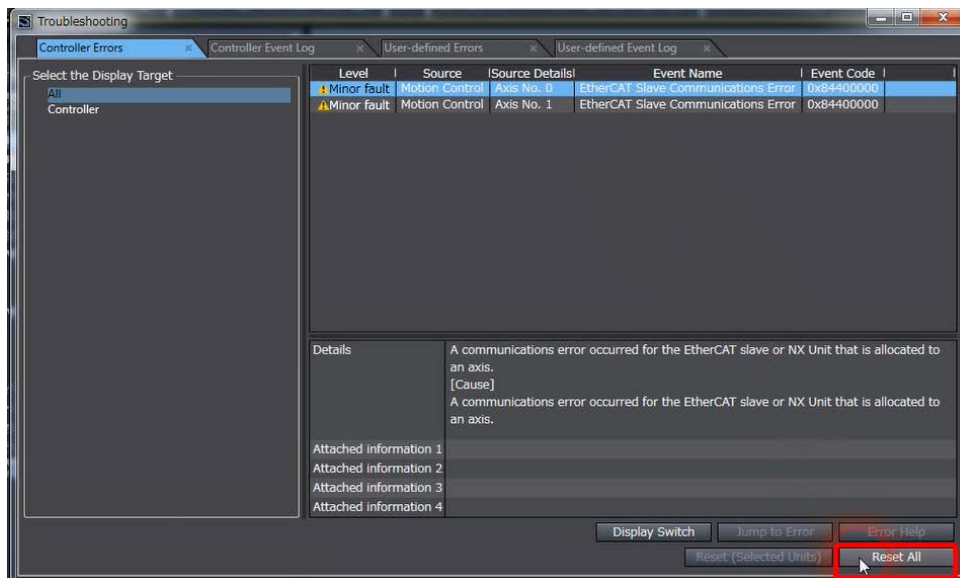

3.8 Easy Tuning (Multiple Drives)

In this section we will explain how to perform Easy tuning for multiple Drives simultaneously. The Motion Controller will perform the motion profile. Before running the program, be sure to place the XY system in the homing position required.

Confirm operating mode of the CPU Unit is in RUN mode and then use control BOOL variables (set/reset) to control the motion control instructions.

Double-click **Section0** under **Programming - POU's - Programs - Program0** in the Multiview Explorer.

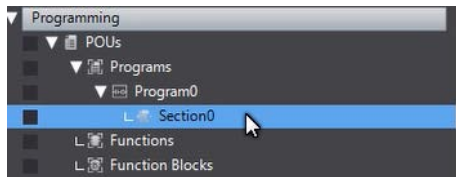

The ladder program is displayed in the Edit Pane.

Change the BOOL variables in the following order :

ServoLock changes to TRUE, Power 1 and Power 2 are executed.



Home changes to TRUE, Home1 and Home2 are executed. Axes position is now at zero position. (Preset position is used)

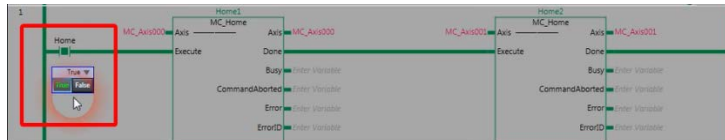

GroupeEnable changes to TRUE, Group1 is executed.

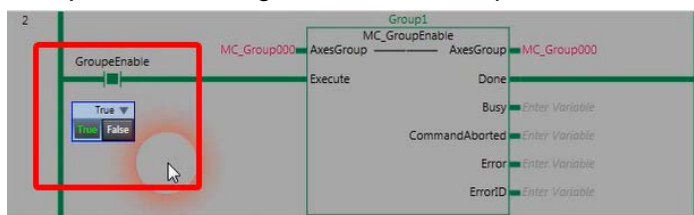

Start changes to TRUE.

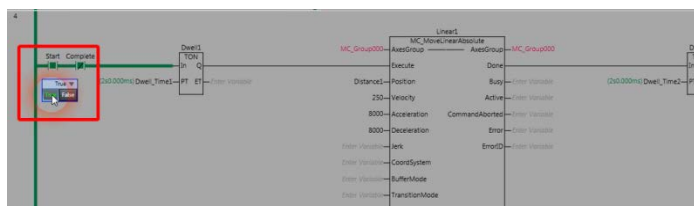

Linear1 is executed and positioning is started for both axes. When the positioning for Linear1 is completed, linear1 execution stops and Linear2 is executed. This operation is repeated with 2 seconds Dwell time between each movement.

Perform the easy tuning (Multiple drives)

1. Right-click **Node1: R88D-1SN01L-ECT** under **Configurations and Setup -EtherCAT** in the Multiview Explorer, and select **Setup and Tuning** from the menu.

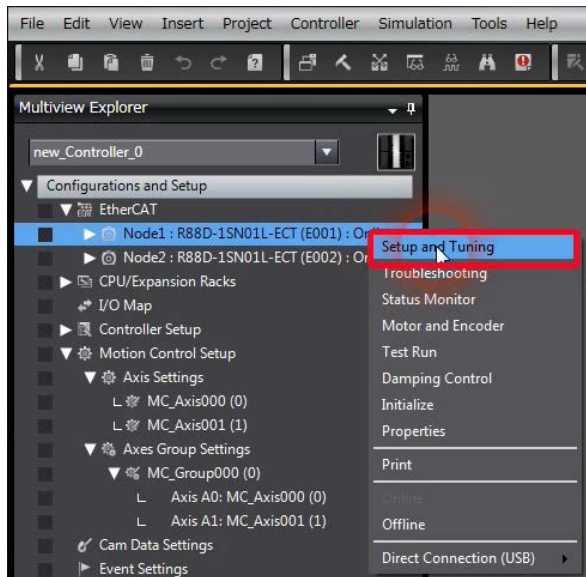

The Setup and Tuning Portal appears in Edit Pane

2. Click the **Easy Tuning** Button under **Tuning (Multiple Drives)**

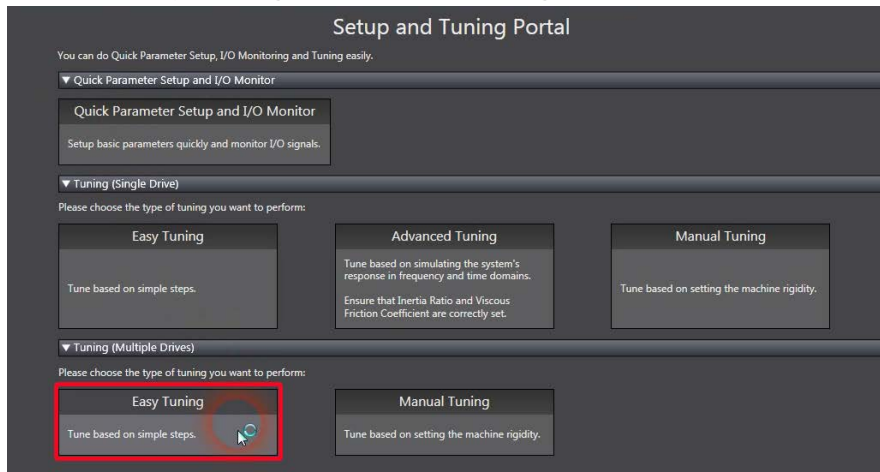

Select Drives to Tune and click the **Ok** Button

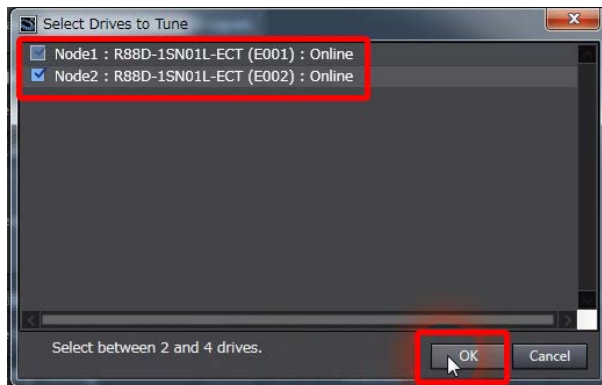

3. Tuning configuration

Select **Simple** mode and click **Next**

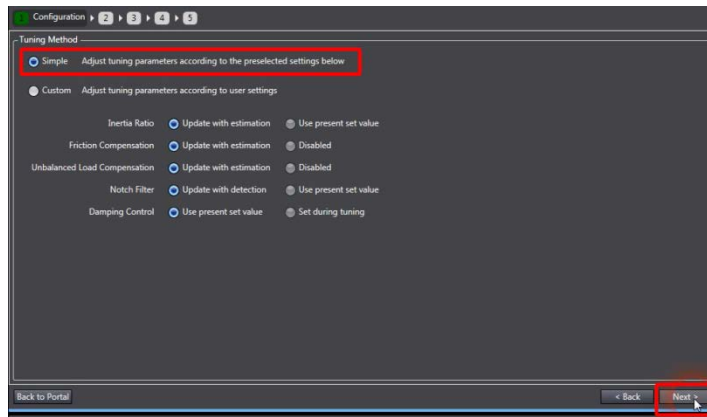

4. Profile and criteria

The motion profile generator is the Motion Controller.
Adjust criteria to achieve tuning and click **Next** button

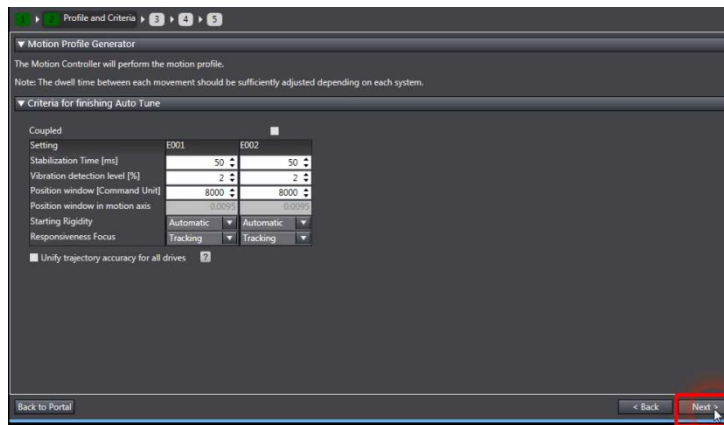

Precautions for Correct Use

The Load Characteristic Estimation function may not operate properly under the following conditions. In such cases, set the related objects manually.

	Conditions that interfere with the Load Characteristic Estimation function
Load inertia	<ul style="list-style-type: none"> · If the load inertia is small, i.e. less than 3 times the rotor inertia or large, i.e. the applicable load inertia or more · If the load inertia changes easily
Load	<ul style="list-style-type: none"> · If the machine rigidity is extremely low · If there is a non-linear element (play), such as a backlash
Operation	<ul style="list-style-type: none"> · If the speed continues at lower than 100 r/min · If the acceleration/deceleration is 2,000 r/min/s or lower · If the acceleration/deceleration torque is small compared with the unbalanced load and the friction torque · If the speed or torque oscillates due to the high gain or small effect of each filter.

5. Auto Tune Monitor

Click the Start Button

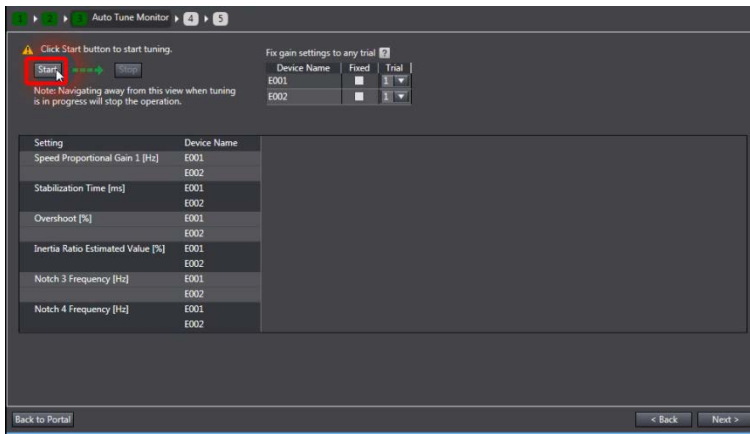

Gain will be increased gradually until achieving the specified settling time. The positioning window, specify the position deviation to determine that the positioning is completed. If it detects a vibration above the vibration detection level during tuning, an adjustment failure will occur.

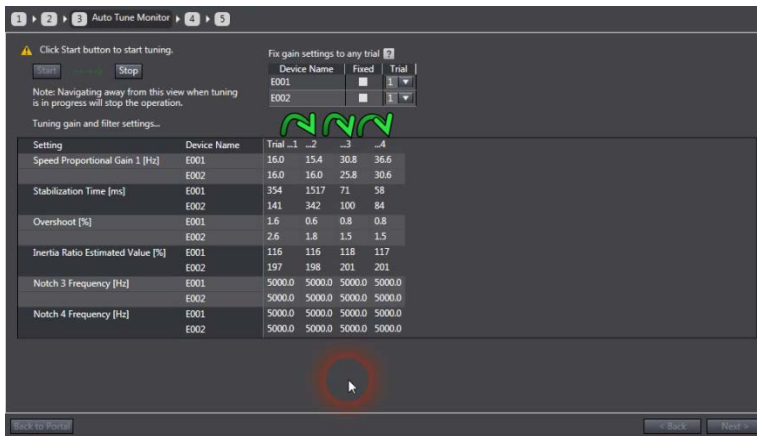

Criteria achieved, click the Ok Button

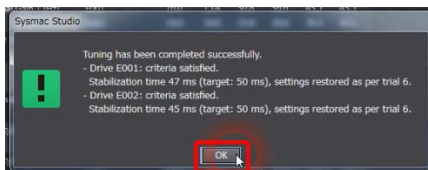

Click the Next Button

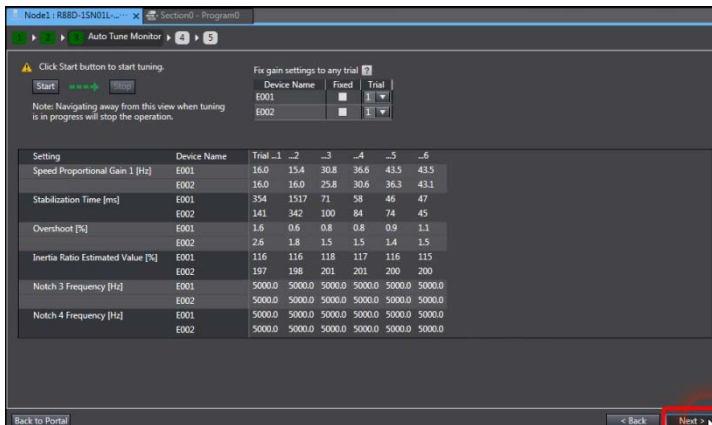

6. Check Behavior

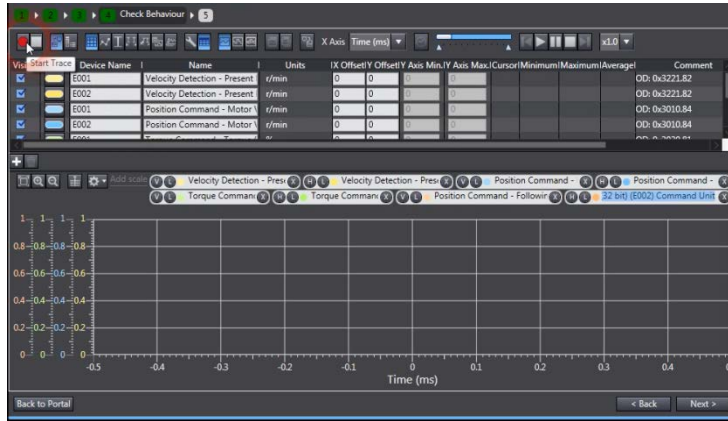

Click the **Record** Button



Monitor data will be traced and automatically scaled

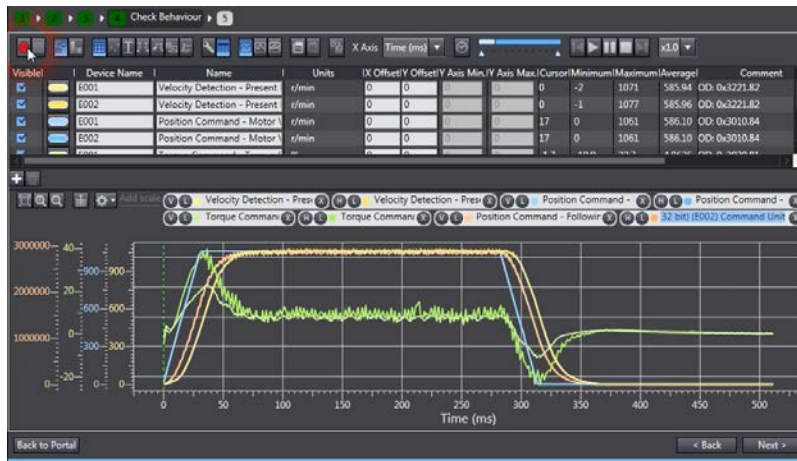

Confirm the behavior and click the **Next** Button

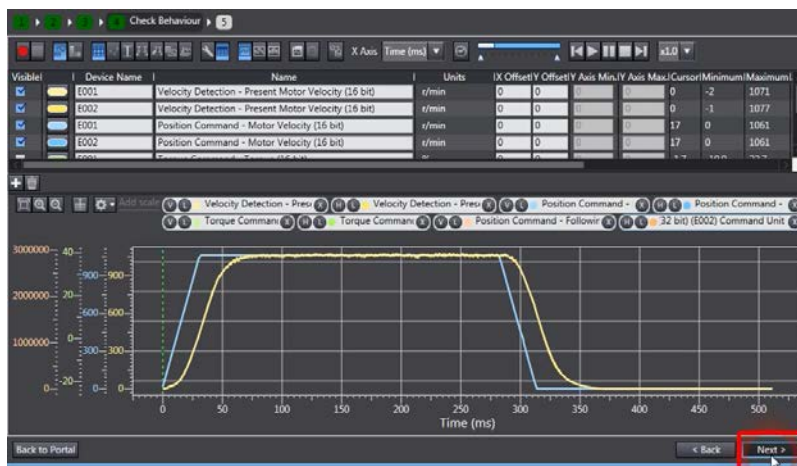

7. Finish

Confirm new gain parameters and save to EEPROM

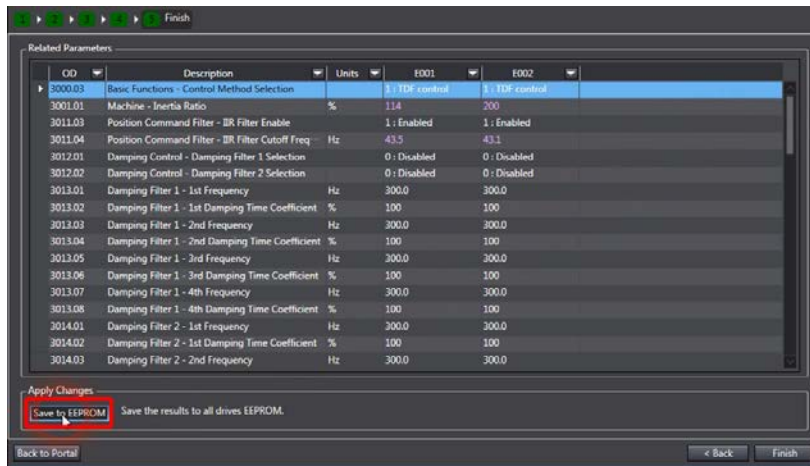

Click the **Ok** Button

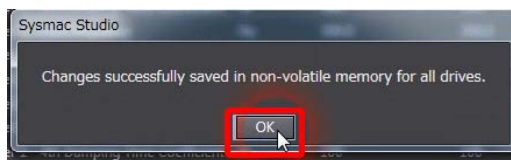

The easy tuning wizard for multiple drives is completed

Click the **Finish** Button

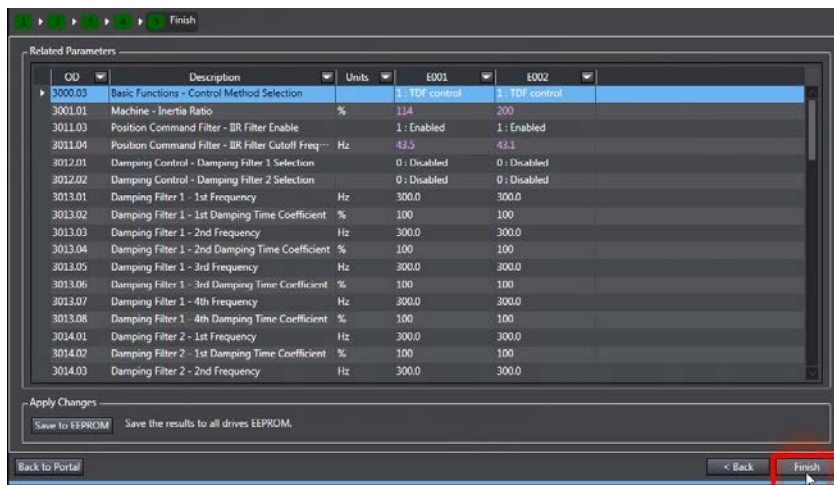

A-1 Settings when control input signals are not wired

An error will occur in the CPU Unit if the Servo parameters for the Servo Drive are left at their default values when the Servo Drive control input signals are not wired. This is because the CPU Unit stops operation when a drive prohibit or immediate stop signal is detected. The minor fault level Controller errors that occur are as follows:

- Error Stop Input (Event code: 68220000)
- Drive Prohibition Input Error (Event code: 64E30000)

This section describes how to temporarily change the Servo parameters to prevent these errors from occurring in the CPU Unit.

The procedure described here assume that a project with a Servo Drive registered to the EtherCAT network configuration has been transferred to the CPU Unit and that the CPU Unit is currently online.

Precautions for Correct Use

If the control input signals are not wired, it will not be possible to stop operation for limit inputs or immediate stop inputs in the event that unexpected motor operation occurs. Remove the coupling from the motor shaft or take other suitable measures to prevent a hazardous condition from occurring.

Perform the following before you perform the procedures that are given in this section.

- Place the Sysmac Studio online with the CPU Unit.
- Transfer to the CPU Unit the project that contains the EtherCAT network configuration in which the Servo Drives are registered.

1. Right-click the Servo Drive and select **Setup and Tuning** from the menu.

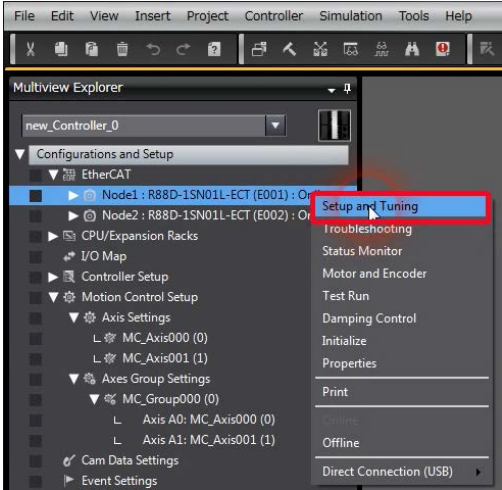

The Setup and Tuning Portal appears.

2. Click the **Quick Parameter Setup and I/O Monitor Button**.

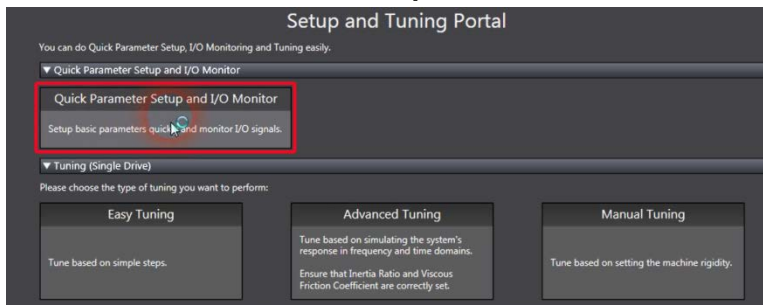

The following dialog box appears. Click the **Yes Button**.

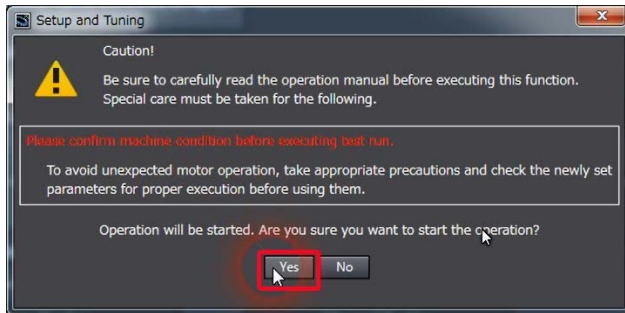

The Motor and Encoder setting Page appears.

3. Click the **Next Button**

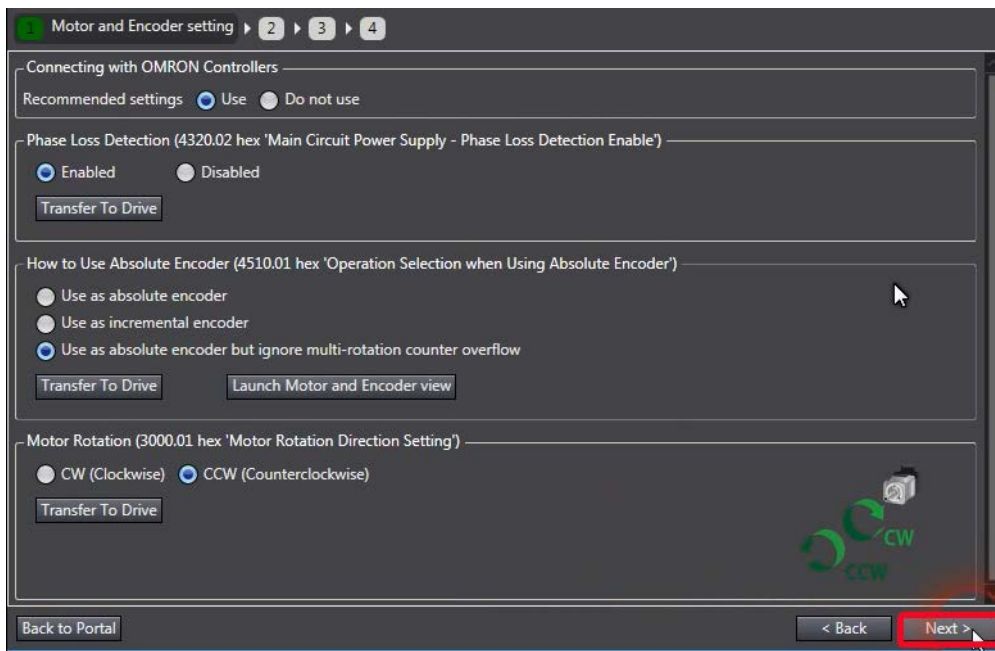

The Input Signals setting Page appears.

5. Change the signal allocation of the below listed input signal, and then click the **Transfer to Drive Button**.

- Error Stop Input
- Positive Drive Prohibit Input
- Negative Drive Prohibit Input

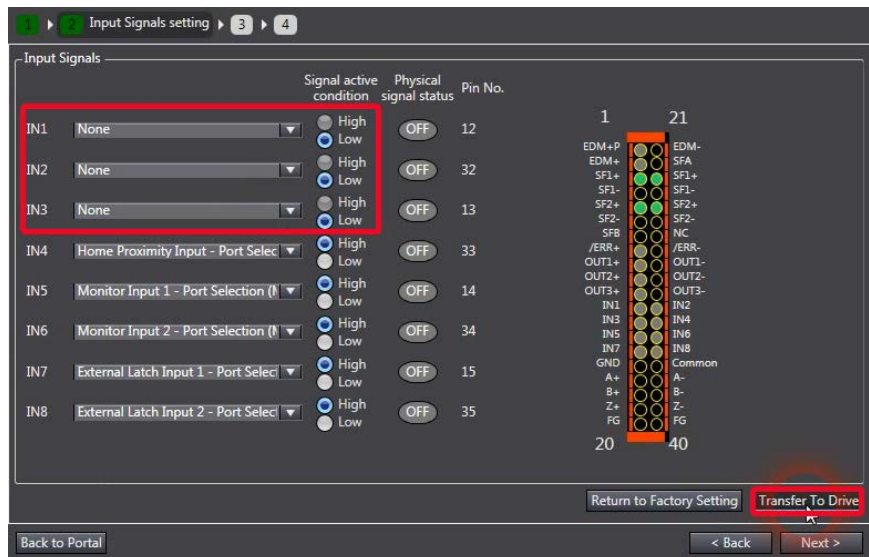

The following dialog box appears. Click the **Yes Button**

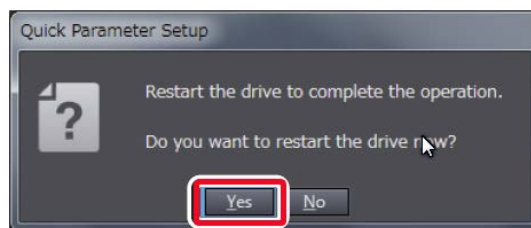

The drive restarts and you return to the Input Signals setting Page.

6. Click the **Next Button**

The Output Signals setting Page appears

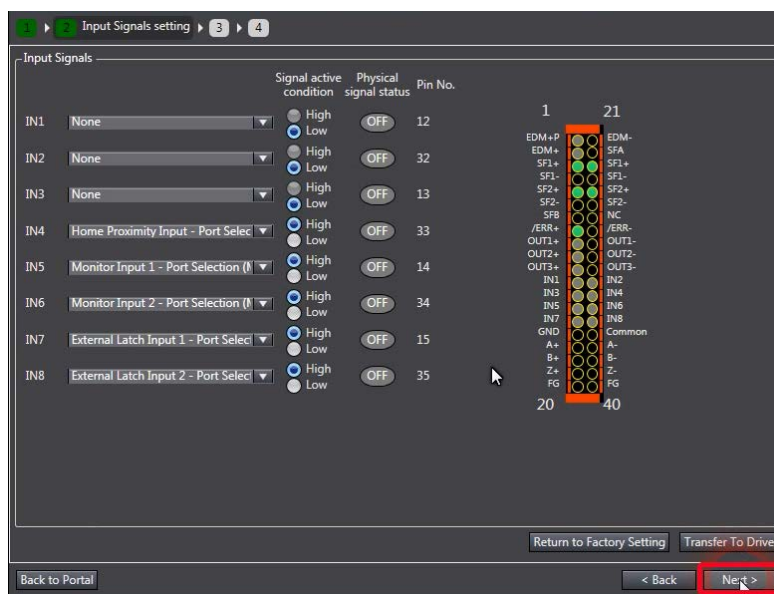

7. Click the **Next** Button

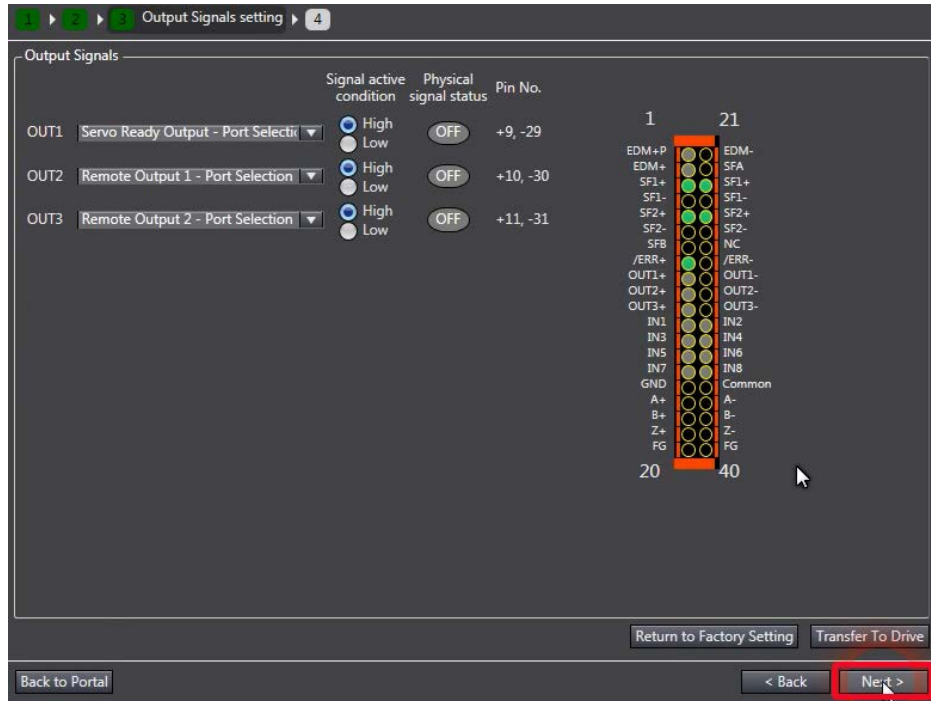

8. Please Set Node2: R88D-1SN01L-ECT(E002) in the same way as Node1. Please click to the **Copy Settings** Button

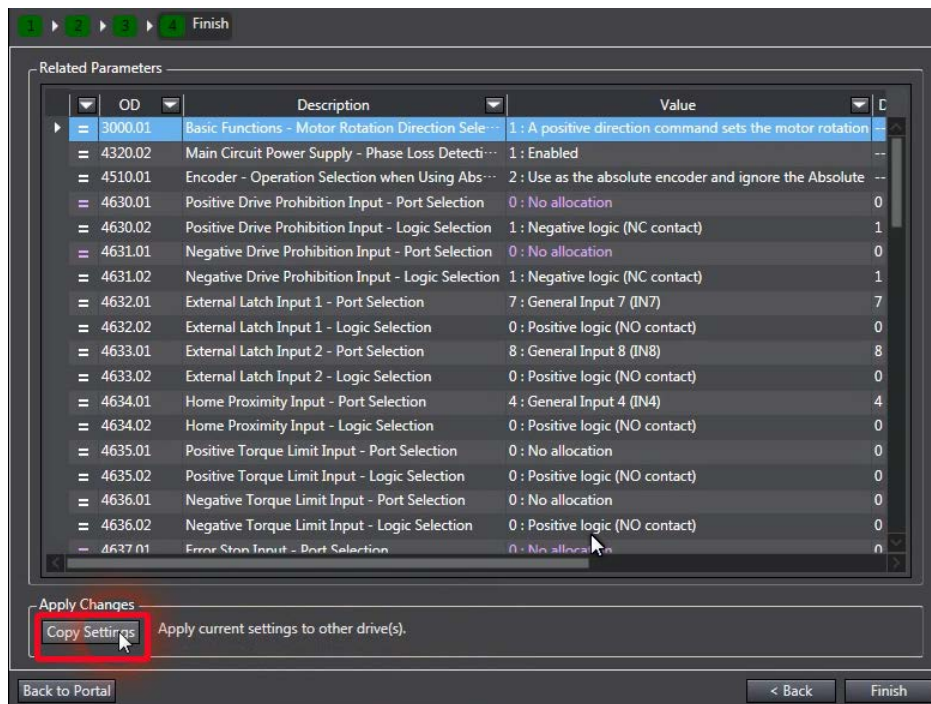

The Copy Settings window appears.

9. Check boxes and click the **Execute** button to start the procedure

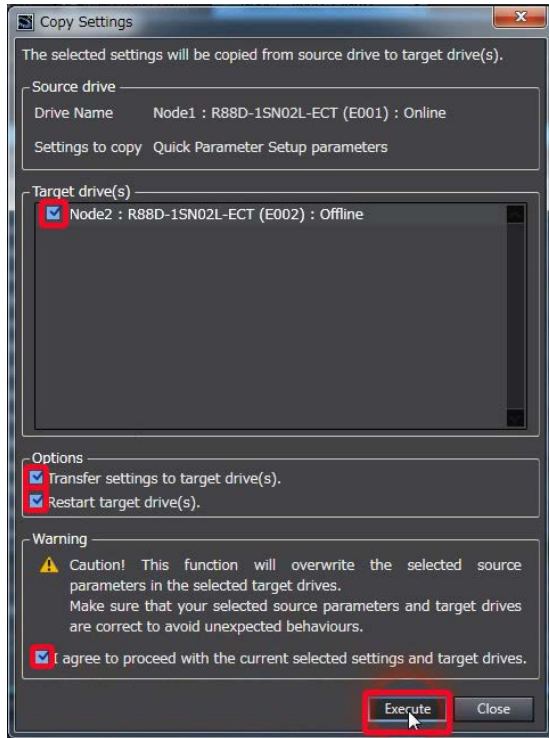

Click the **Yes** Button to confirm the copy settings

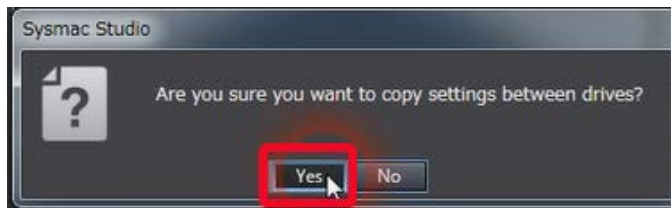

Click the **Yes** Button to transfer settings to target drive

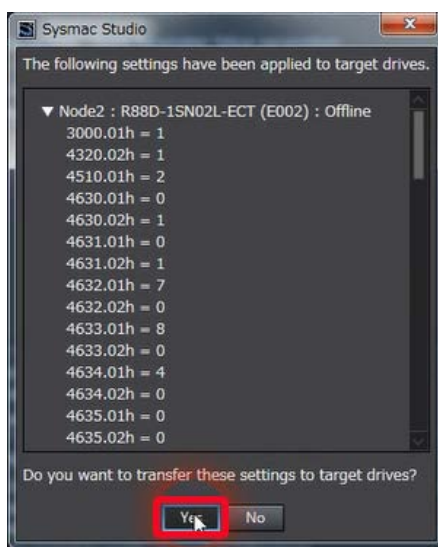

The target drive is restarting

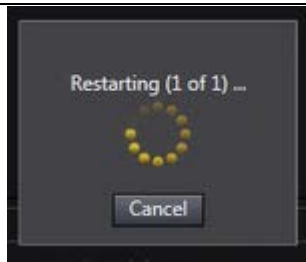

Settings are now effective in the target drive, click the **Ok** Button

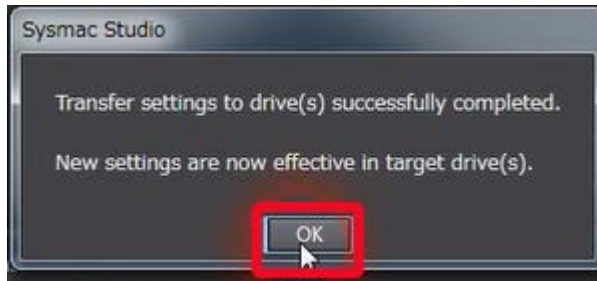

Click the **Close** Button

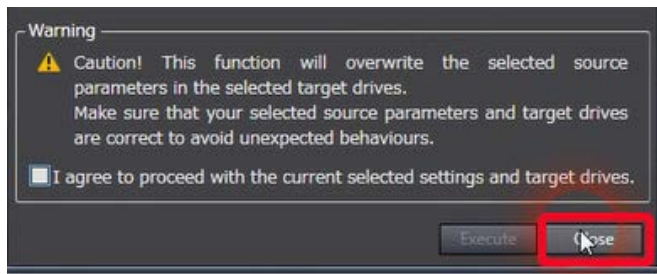

Click the **Finish** Button

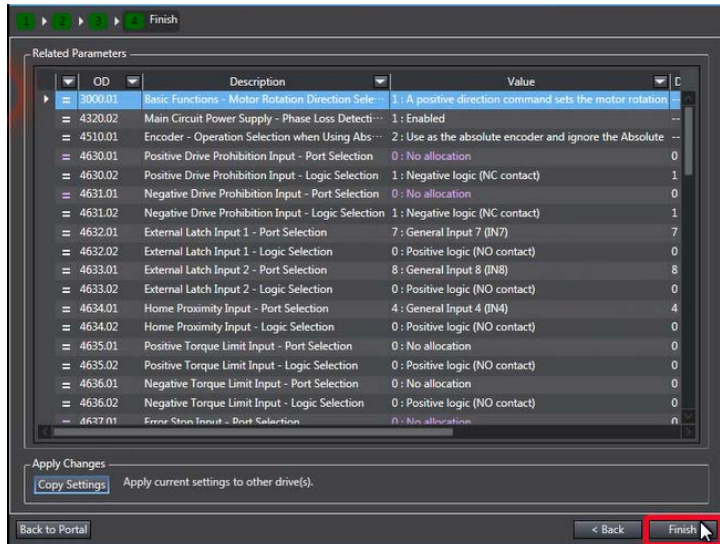

This concludes the procedure to change Input settings of Node 1 and Node 2.

- Following above procedure, drives have been restarted to apply Input settings. Please Reset the EtherCAT Slave Communication Error in the CPU Unit with Troubleshooting window.

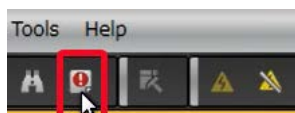

Click on **Reset All** button

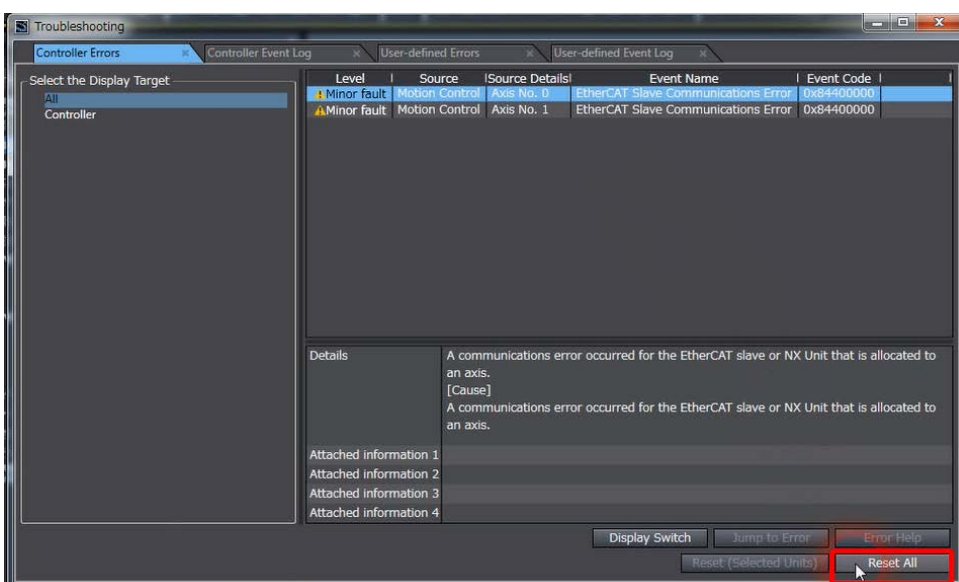

Confirm the below message and lick on **Yes** button

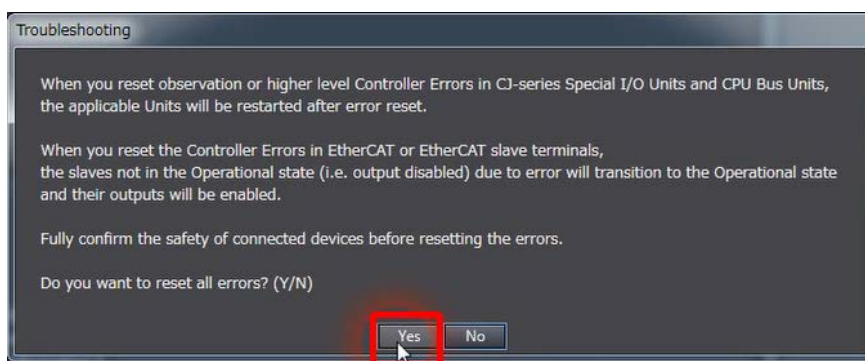

Errors are now resetted

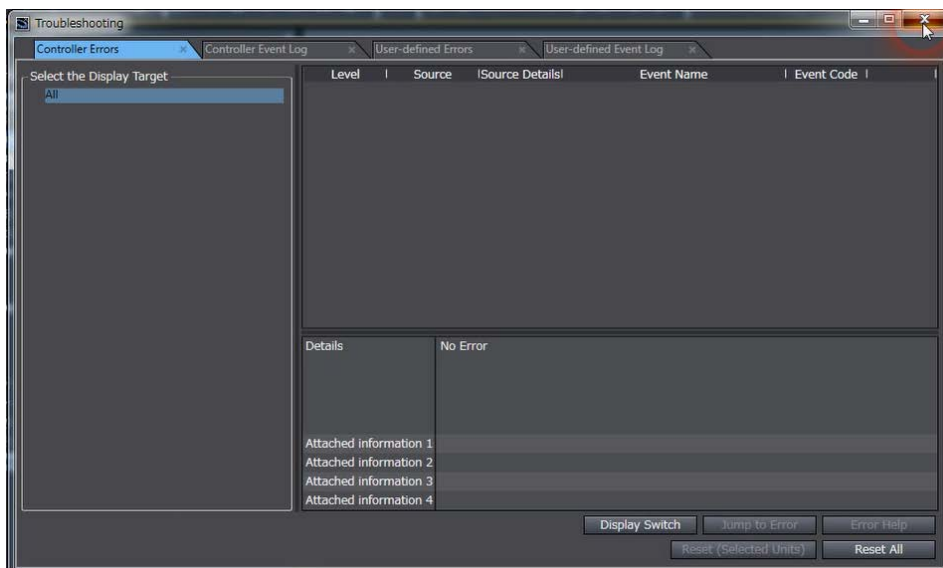

A-2 Program making with structured text

Below is an alternative program to move the XY stage with structured text.

```
Power1(Axis:=MC_Axis000, Enable:=ServoLock);
```

```
Power2(Axis:=MC_Axis001, Enable:=ServoLock);
```

```
Home1(Axis:=MC_Axis000, Execute:=Home);
```

```
Home2(Axis:=MC_Axis001, Execute:=Home);
```

```
Group1(AxesGroup:=MC_Group000, Execute:=GroupEnable);
```

```
Distance1[0]:=0;
```

```
Distance1[1]:=0;
```

```
Distance2[0]:=50;
```

```
Distance2[1]:=50;
```

```
Dwell_Time1:=TIME#2s;
```

```
Dwell_Time2:=TIME#2s;
```

```
Dwell1(In:=Start AND NOT Complete, PT:=Dwell_Time1, Q=>Go_Linear1);
```

```
Dwell2(In:=Start AND NOT Complete AND MoveLinear1.Done, PT:=Dwell_Time2,  
Q=>Go_Linear2);
```

```
MoveLinear1(AxesGroup:=MC_Group000, Execute:=Go_Linear1, Position:=Distance1,  
Velocity:=250, Acceleration:=8000, Deceleration:=8000);
```

```
MoveLinear2(AxesGroup:=MC_Group000, Execute:=Go_Linear2, Position:=Distance2,  
Velocity:=250, Acceleration:=8000, Deceleration:=8000, Done=>Complete);
```

Note: Do not use this document to operate the Unit.

OMRON Corporation Industrial Automation Company

Tokyo, JAPAN

Contact: www.ia.omron.com

Regional Headquarters

OMRON EUROPE B.V.

Wegalaan 67-69, 2132 JD Hoofddorp
The Netherlands
Tel: (31)2356-81-300/Fax: (31)2356-81-388

OMRON ELECTRONICS LLC

2895 Greenspoint Parkway, Suite 200
Hoffman Estates, IL 60169 U.S.A
Tel: (1) 847-843-7900/Fax: (1) 847-843-7787

OMRON ASIA PACIFIC PTE. LTD.

No. 438A Alexandra Road # 05-05/08 (Lobby 2),
Alexandra Technopark,
Singapore 119967
Tel: (65) 6835-3011/Fax: (65) 6835-2711

OMRON (CHINA) CO., LTD.

Room 2211, Bank of China Tower,
200 Yin Cheng Zhong Road,
PuDong New Area, Shanghai, 200120, China
Tel: (86) 21-5037-2222/Fax: (86) 21-5037-2200

Authorized Distributor:

© OMRON Corporation 2017 All Rights Reserved.
In the interest of product improvement,
specifications are subject to change without notice.

Cat. No. I827-E1-01

0317 (0317)