



**Controller**

KUKA Roboter GmbH

## **KR C4 compact**

**Operating Instructions**

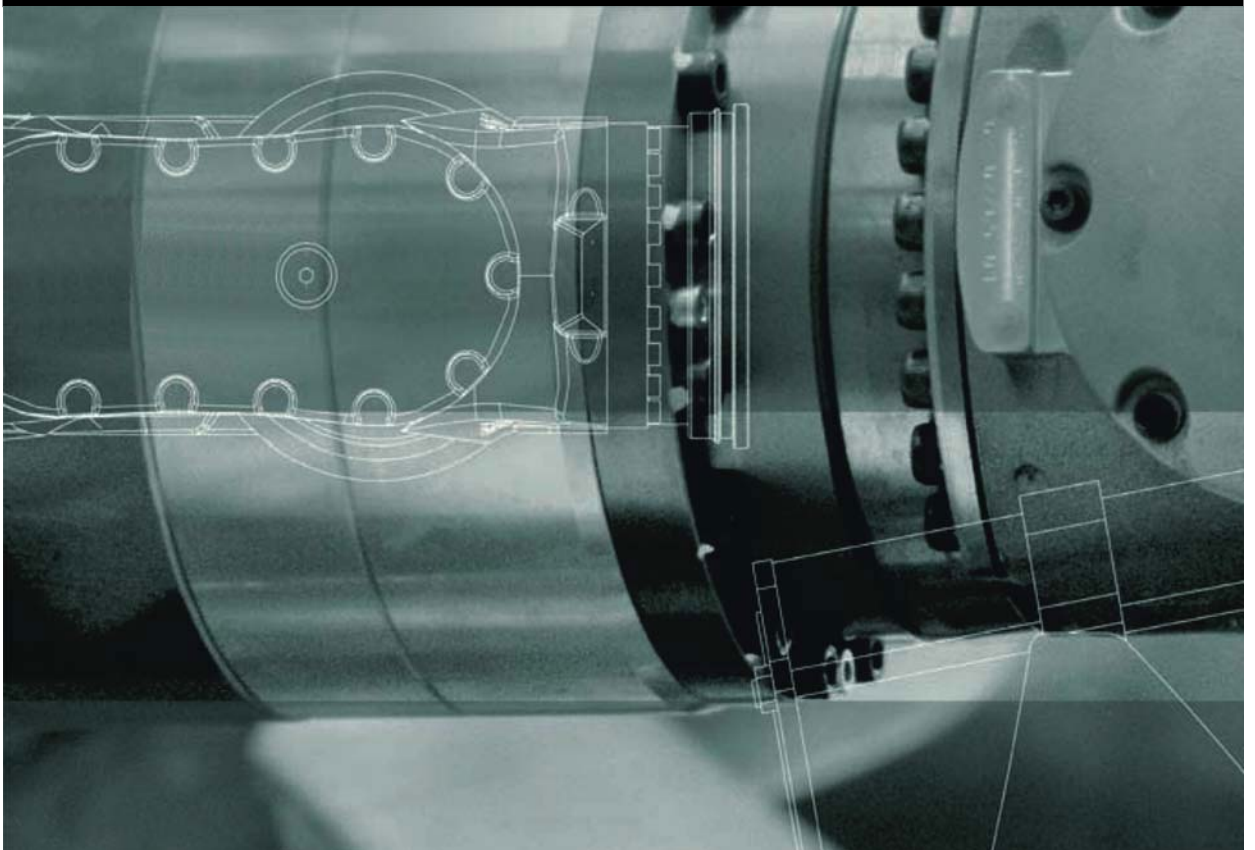

Issued: 15.04.2014

Version: BA KR C4 compact V5



© Copyright 2014

KUKA Roboter GmbH  
Zugspitzstraße 140  
D-86165 Augsburg  
Germany

This documentation or excerpts therefrom may not be reproduced or disclosed to third parties without the express permission of KUKA Roboter GmbH.

Other functions not described in this documentation may be operable in the controller. The user has no claims to these functions, however, in the case of a replacement or service work.

We have checked the content of this documentation for conformity with the hardware and software described. Nevertheless, discrepancies cannot be precluded, for which reason we are not able to guarantee total conformity. The information in this documentation is checked on a regular basis, however, and necessary corrections will be incorporated in the subsequent edition.

Subject to technical alterations without an effect on the function.

Translation of the original documentation

KIM-PS5-DOC

Publication:	Pub BA KR C4 compact (PDF) en
Book structure:	BA KR C4 compact V5.3
Version:	BA KR C4 compact V5

## Contents

<b>1</b>	<b>Introduction</b>	<b>7</b>
1.1	Industrial robot documentation	7
1.2	Representation of warnings and notes	7
1.3	Trademarks	7
1.4	Terms used	8
<b>2</b>	<b>Purpose</b>	<b>9</b>
2.1	Target group	9
2.2	Intended use	9
<b>3</b>	<b>Product description</b>	<b>11</b>
3.1	Description of the industrial robot	11
3.2	Overview of the KR C4 compact robot controller	11
3.3	Control box	12
3.3.1	Control PC	12
3.3.2	Cabinet Control Unit, Small Robot	13
3.3.3	Low-voltage power supply unit	14
3.3.4	Batteries	14
3.3.5	Mains filter	14
3.4	Drive box (Drive Configuration (DC))	14
3.5	Description of interfaces	15
3.5.1	Control PC interfaces	16
3.5.1.1	Motherboard D3076-K PC interfaces	17
3.5.1.2	Motherboard D3236-K PC interfaces	18
3.6	Cooling	19
<b>4</b>	<b>Technical data</b>	<b>21</b>
4.1	Dimensions	22
4.2	Cabinet Interface Board, Small Robot	23
4.3	Dimensions of the smartPAD holder (optional)	24
4.4	Dimensions of handle brackets	25
4.5	Plates and labels	25
<b>5</b>	<b>Safety</b>	<b>27</b>
5.1	General	27
5.1.1	Liability	27
5.1.2	Intended use of the industrial robot	27
5.1.3	EC declaration of conformity and declaration of incorporation	28
5.1.4	Terms used	28
5.2	Personnel	30
5.3	Workspace, safety zone and danger zone	31
5.4	Triggers for stop reactions	31
5.5	Safety functions	32
5.5.1	Overview of the safety functions	32
5.5.2	Safety controller	33
5.5.3	Mode selection	33
5.5.4	“Operator safety” signal	33
5.5.5	EMERGENCY STOP device	34

5.5.6	Logging off from the higher-level safety controller .....	34
5.5.7	External EMERGENCY STOP device .....	35
5.5.8	Enabling device .....	35
5.5.9	External enabling device .....	36
5.5.10	External safe operational stop .....	36
5.5.11	External safety stop 1 and external safety stop 2 .....	36
5.5.12	Velocity monitoring in T1 .....	36
5.6	Additional protective equipment .....	36
5.6.1	Jog mode .....	36
5.6.2	Software limit switches .....	37
5.6.3	Mechanical end stops .....	37
5.6.4	Mechanical axis range limitation (optional) .....	37
5.6.5	Axis range monitoring (optional) .....	37
5.6.6	Options for moving the manipulator without drive energy .....	38
5.6.7	Labeling on the industrial robot .....	38
5.6.8	External safeguards .....	39
5.7	Overview of operating modes and safety functions .....	39
5.8	Safety measures .....	40
5.8.1	General safety measures .....	40
5.8.2	Transportation .....	41
5.8.3	Start-up and recommissioning .....	41
5.8.3.1	Checking machine data and safety configuration .....	42
5.8.3.2	Start-up mode .....	43
5.8.4	Manual mode .....	44
5.8.5	Simulation .....	45
5.8.6	Automatic mode .....	45
5.8.7	Maintenance and repair .....	46
5.8.8	Decommissioning, storage and disposal .....	47
5.8.9	Safety measures for "single point of control" .....	47
5.9	Applied norms and regulations .....	48
<b>6</b>	<b>Planning</b> .....	<b>51</b>
6.1	Overview of planning .....	51
6.2	Electromagnetic compatibility (EMC) .....	51
6.3	Installation conditions .....	51
6.4	Connection conditions .....	52
6.5	Power supply connection .....	53
6.6	Safety interface X11 .....	53
6.6.1	Safety interface X11 .....	54
6.6.2	Wiring example for E-STOP circuit and safeguard .....	57
6.6.3	Wiring example for safe inputs and outputs .....	59
6.7	Safety functions via Ethernet safety interface (optional) .....	61
6.7.1	Schematic circuit diagram for enabling switches .....	64
6.7.2	SafeOperation via Ethernet safety interface (optional) .....	65
6.7.3	Ethernet interface (1xRJ45) X66 .....	68
6.8	Mastering test .....	68
6.9	EtherCAT interface X65 .....	68
6.10	Service Interface X69 .....	69
6.11	PE equipotential bonding .....	70

6.12	Performance level .....	70
6.12.1	PFH values of the safety functions .....	70
<b>7</b>	<b>Transportation</b> .....	<b>73</b>
7.1	Transporting the robot controller .....	73
<b>8</b>	<b>Start-up and recommissioning</b> .....	<b>75</b>
8.1	Start-up overview .....	75
8.2	Installing the robot controller .....	76
8.3	Connecting the connecting cables .....	76
8.4	Plugging in the KUKA smartPAD .....	77
8.5	Connecting the PE equipotential bonding .....	78
8.6	Connecting the robot controller to the power supply .....	78
8.7	Reversing the battery discharge protection measures .....	78
8.8	Configuring and connecting connector X11 .....	79
8.9	Switching on the robot controller .....	79
<b>9</b>	<b>Operation</b> .....	<b>81</b>
9.1	KUKA smartPAD teach pendant .....	81
9.1.1	Front view .....	81
9.1.2	Rear view .....	83
<b>10</b>	<b>Maintenance</b> .....	<b>85</b>
10.1	Maintenance symbols .....	85
10.2	Checking CCU_SR relay outputs .....	86
10.3	Cleaning the robot controller .....	87
<b>11</b>	<b>Repair</b> .....	<b>89</b>
11.1	Repair and procurement of spare parts .....	89
11.2	Opening the housing cover .....	89
11.3	Removing the control box from the drive box .....	90
11.4	Exchanging the motherboard .....	91
11.5	Exchanging the motherboard battery .....	91
11.6	Exchanging DIMM memory modules .....	91
11.7	Exchanging the hard drive .....	92
11.8	Exchanging the Cabinet Control Unit, Small Robot .....	93
11.9	Exchanging the batteries .....	95
11.10	Exchanging the Dual GbE network card .....	97
11.11	Exchanging the low-voltage power supply unit .....	97
11.12	Exchanging the control box fans .....	98
11.13	Exchanging the drive box fans .....	99
11.14	Exchanging the KPP_SR .....	100
11.15	Exchanging the KSP_SR .....	101
11.16	Installing the KUKA System Software (KSS) .....	102
<b>12</b>	<b>Troubleshooting</b> .....	<b>103</b>
12.1	LED display on Cabinet Control Unit, Small Robot .....	103
12.2	Fuses on the Cabinet Control Unit, Small Robot .....	107
<b>13</b>	<b>Decommissioning, storage and disposal</b> .....	<b>109</b>

13.1	Decommissioning .....	109
13.2	Storage .....	109
13.3	Disposal .....	109
<b>14</b>	<b>KUKA Service .....</b>	<b>111</b>
14.1	Requesting support .....	111
14.2	KUKA Customer Support .....	111
	<b>Index .....</b>	<b>119</b>

# 1 Introduction

## 1.1 Industrial robot documentation

The industrial robot documentation consists of the following parts:

- Documentation for the manipulator
- Documentation for the robot controller
- Operating and programming instructions for the System Software
- Instructions for options and accessories
- Parts catalog on storage medium

Each of these sets of instructions is a separate document.

## 1.2 Representation of warnings and notes

### Safety

These warnings are relevant to safety and **must** be observed.

 <b>DANGER</b>	These warnings mean that it is certain or highly probable that death or severe injuries <b>will</b> occur, if no precautions are taken.
---	---

 <b>WARNING</b>	These warnings mean that death or severe injuries <b>may</b> occur, if no precautions are taken.
--	--

 <b>CAUTION</b>	These warnings mean that minor injuries <b>may</b> occur, if no precautions are taken.
--	--

<b>NOTICE</b>	These warnings mean that damage to property <b>may</b> occur, if no precautions are taken.
---------------	--

	These warnings contain references to safety-relevant information or general safety measures. These warnings do not refer to individual hazards or individual precautionary measures.
---	---

This warning draws attention to procedures which serve to prevent or remedy emergencies or malfunctions:



<b>SAFETY INSTRUCTIONS</b>	Procedures marked with this warning <b>must</b> be followed exactly.
----------------------------	--

### Notes

These notices serve to make your work easier or contain references to further information.

	Tip to make your work easier or reference to further information.
---	---

## 1.3 Trademarks

- **Windows** is a trademark of Microsoft Corporation.
-  is a trademark of Beckhoff Automation GmbH.
-  is a trademark of ODVA.

## 1.4 Terms used

Term	Description
CIP Safety	<b>Common Industrial Protocol Safety</b> CIP Safety is an Ethernet/IP-based safety interface for connecting a safety PLC to the robot controller. (PLC = master, robot controller = slave)
CCU_SR	<b>Cabinet Control Unit Small Robot</b>
CIB_SR	<b>Cabinet Interface Board Small Robot</b>
Dual NIC card	Dual network card
EDS	<b>Electronic Data Storage</b> (memory card)
EMD	<b>Electronic Mastering Device</b>
EMC	Electromagnetic compatibility
KCB	<b>KUKA Controller Bus</b>
KEB	<b>KUKA Extension Bus</b>
KEI	<b>KUKA Extension Interface</b>
KLI	<b>KUKA Line Interface</b> . Connection to higher-level control infrastructure (PLC, archiving)
KOI	<b>KUKA Option Interface</b>
KONI	<b>KUKA Option Network Interface</b>
KPC	Control PC
KPP_SR	<b>KUKA Power Pack Small Robot</b>
KRL	KUKA Robot programming language ( <b>KUKA Robot Language</b> )
KSB	<b>KUKA System Bus</b> . Internal KUKA bus for internal networking of the controllers with each other
KSI	<b>KUKA Service Interface</b>
KSP_SR	<b>KUKA Servo Pack Small Robot</b>
KSS	<b>KUKA System Software</b>
Manipulator	The robot arm and the associated electrical installations
PMB_SR	<b>Power Management Board Small Robot</b>
RDC	<b>Resolver Digital Converter</b>
SATA connections	Data bus for exchanging data between the processor and the hard drive
USB	<b>Universal Serial Bus</b> . Bus system for connecting additional devices to a computer
EA	External axis (linear unit, Posiflex)



## 2 Purpose

### 2.1 Target group

This documentation is aimed at users with the following knowledge and skills:

- Advanced knowledge of electrical and electronic systems
- Advanced knowledge of the robot controller
- Advanced knowledge of the Windows operating system



For optimal use of our products, we recommend that our customers take part in a course of training at KUKA College. Information about the training program can be found at [www.kuka.com](http://www.kuka.com) or can be obtained directly from our subsidiaries.

### 2.2 Intended use

**Use** The robot controller KR C4 compact is intended solely for operating the following components:

- KUKA industrial robots

**Misuse** Any use or application deviating from the intended use is deemed to be misuse and is not allowed. This includes e.g.:

- Use as a climbing aid
- Operation outside the permissible operating parameters
- Use in potentially explosive environments
- Use in underground mining



## 3 Product description

### 3.1 Description of the industrial robot

The industrial robot consists of the following components:

- Manipulator
- Robot controller
- smartPAD teach pendant
- Connecting cables
- Software
- Options, accessories

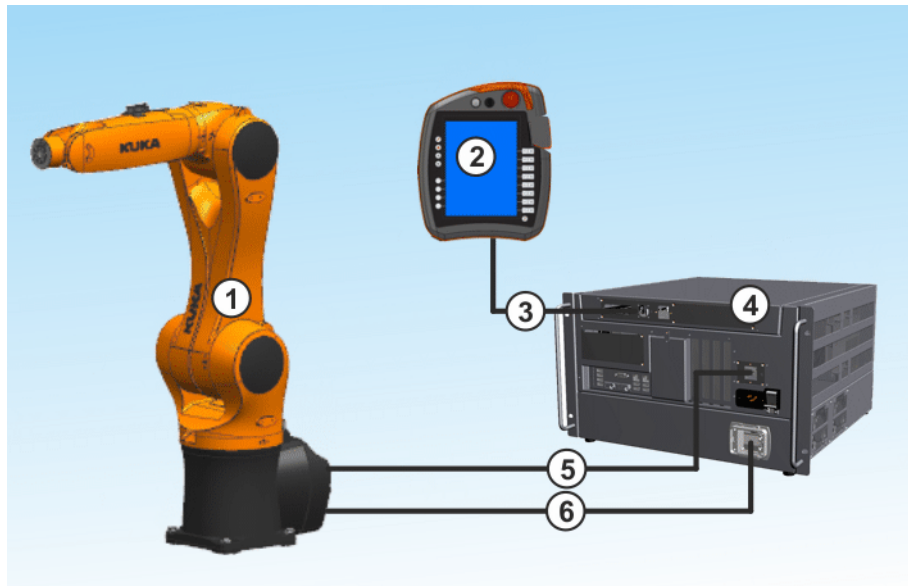

**Fig. 3-1: Example of an industrial robot**

- 1 Manipulator
- 2 Teach pendant
- 3 Connecting cable, smartPAD
- 4 Robot controller
- 5 Connecting cable, data cable
- 6 Connecting cable, motor cable

### 3.2 Overview of the KR C4 compact robot controller

The robot controller is used for controlling the following systems:

- KUKA Small Robots

The robot controller consists of the following components:

- Control PC
- Power unit
- Safety logic
- smartPAD teach pendant
- Connection panel

The robot controller can be installed in a 19" rack.

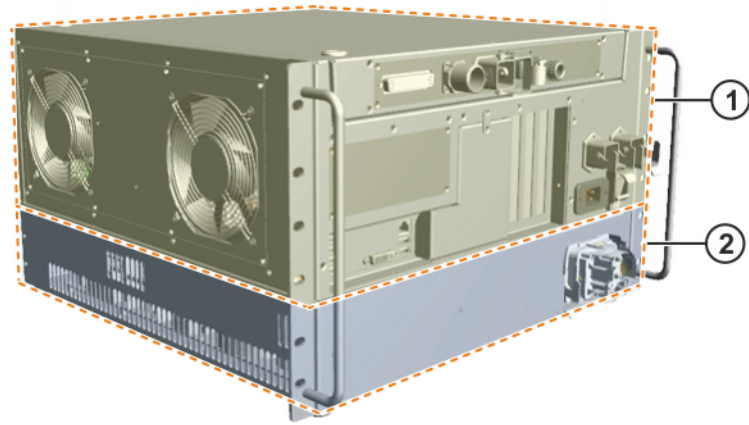
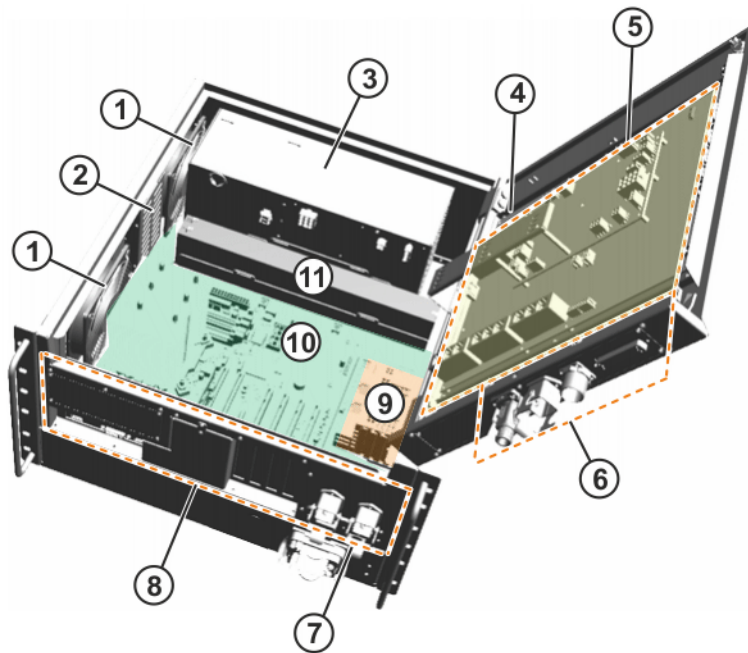

**Fig. 3-2: Overview of KR C4 compact**

- 1 Control unit (control box)
- 2 Power unit (drive box)

### 3.3 Control box

The control box consists of the following components:



**Fig. 3-3: Overview of control box**

- |  |                |
|--|----------------|
| 1 Fan  | 7 Main switch  |
| 2 Hard drive                                 | 8 Interfaces   |
| 3 Low-voltage power supply unit              | 9 Options      |
| 4 Memory card (EDS)                          | 10 Motherboard |
| 5 Cabinet Control Unit, Small Robot (CCU_SR) | 11 Batteries   |
| 6 Interfaces in the cover                    |                |

#### 3.3.1 Control PC

**Components**

The control PC (KPC) includes the following components:

- Motherboard
- Processor
- Heat sink
- Memory modules
- Hard drive
- LAN Dual NIC network card (not present on all motherboard variants)
- Optional modules, e.g. field bus cards

**Functions**

The control PC (KPC) is responsible for the following functions of the robot controller:

- User interface
- Program creation, correction, archiving, and maintenance
- Sequence control
- Path planning
- Control of the drive circuit
- Monitoring
- Safety equipment
- Communication with external periphery (other controllers, host computers, PCs, network)

**3.3.2 Cabinet Control Unit, Small Robot****Description**

The Cabinet Control Unit, Small Robot (CCU\_SR) is the central power distributor and communication interface for all components of the robot controller. The CCU\_SR consists of the Cabinet Interface Board, Small Robot (CIB\_SR) and the Power Management Board, Small Robot (PMB\_SR). All data are transferred via this internal communication interface to the controller for further processing. If the mains voltage fails, the control components continue to be powered by batteries until the position data are saved and the controller has shut down. The charge and quality of the batteries are checked by means of a load test.

The CCU\_SR also incorporates sensing, control and switching functions. The output signals are provided as electrically isolated outputs.

**Functions**

- Communication interface for the components of the robot controller
- Safe inputs and outputs
  - Contactor activation
  - 4 floating outputs
  - 9 safe inputs
  - Teach pendant plugged in
  - Mastering test
- 6 Fast Measurement inputs for customer applications
- Fan power supply monitoring
- Temperature sensing:
  - Control box internal temperature
- The following components are connected to the KPC via the KUKA Controller Bus:
  - Drive box
  - Resolver digital converter
- The following operator panels and service devices are connected to the control PC via the KUKA System Bus:
  - KUKA Operator Panel Interface

- Diagnostic LEDs
- Electronic Data Storage interface

#### Power supply with battery backup

- Drive box
- KUKA smartPAD
- Multi-core control PC
- Resolver Digital Converter (RDC)

#### Power supply without battery backup

- Motor brakes
- Customer interface

### 3.3.3 Low-voltage power supply unit

**Description** The low-voltage power supply unit provides power to the components of the robot controller.

A green LED indicates the operating state of the low-voltage power supply unit.

### 3.3.4 Batteries

**Description** In the event of a power failure, or if the power is switched off, the batteries enable the robot controller to be shut down in a controlled manner. The batteries are charged via the CCU and the charge is checked and indicated.

### 3.3.5 Mains filter

**Description** The mains filter (interference suppressor filter) suppresses interference voltages on the power cable.

## 3.4 Drive box (Drive Configuration (DC))

The drive box consists of the following components:

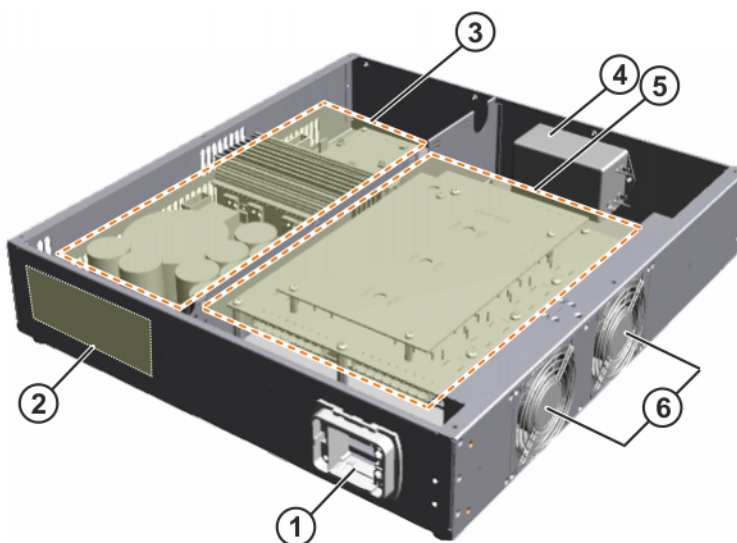

Fig. 3-4: Overview of drive box

1	Motor connector X20	4	Mains filter
2	Brake resistor	5	KUKA Servo Pack, Small Robot (KSP_SR)
3	KUKA Power Pack, Small Robot (KPP_SR)	6	Fans

**Functions**

The drive box performs the following functions:

- Generation of the intermediate circuit voltage
- Control of the motors
- Control of the brakes
- Checking of intermediate circuit voltage in braking mode

**3.5 Description of interfaces****Overview**

The connection panel of the robot controller consists as standard of connections for the following cables:

- Power supply cable
- Motor/data cable
- smartPAD cable
- Peripheral cables

The configuration of the connection panel varies according to the customer-specific version and the options required.

**Note**

The following safety interfaces can be configured in the robot controller:

- Discrete safety interface X11
- Ethernet safety interface X66
  - PROFIsafe KLI or
  - CIP Safety KLI



The discrete safety interface X11 and the Ethernet safety interface X66 cannot be connected and used together. Only one of the safety interfaces can be used at a time.

The configuration of the connection panel varies according to customer requirements and options. In this documentation, the robot controller is described with the maximum configuration.

## Connection panel

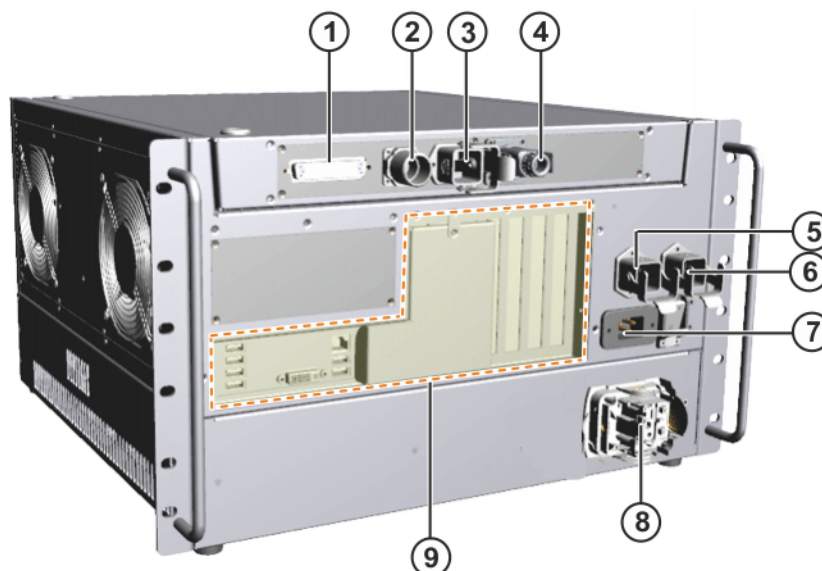

**Fig. 3-5: KR C4 compact interfaces**

- 1 X11 Safety interface (option)
- 2 X19 smartPAD connection
- 3 X65 Extension interface
- 4 X69 Service interface
- 5 X21 Manipulator interface
- 6 X66 Ethernet safety interface
- 7 X1 Power supply connection
- 8 X20 Motor connector
- 9 Control PC interfaces



Only safety interface X11 or Ethernet safety interface X66 (PRO-FIsafe/CIP Safety) can be configured.



All contactor, relay and valve coils that are connected to the robot controller by the user must be equipped with suitable suppressor diodes. RC elements and VCR resistors are not suitable.



KUKA Roboter GmbH has assembled, tested and supplied the motherboard with an optimum configuration. No liability will be accepted for modifications to the configuration that have not been carried out by KUKA Roboter GmbH.

### 3.5.1 Control PC interfaces

#### Motherboards

The following motherboard variants can be installed in the control PC:

- D3076-K
- D3236-K



### 3.5.1.1 Motherboard D3076-K PC interfaces

#### Overview

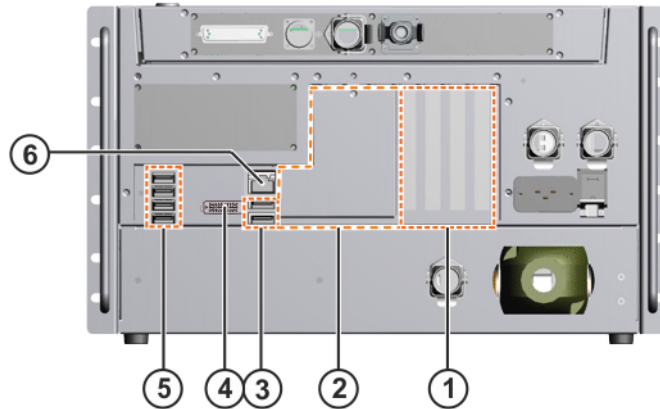
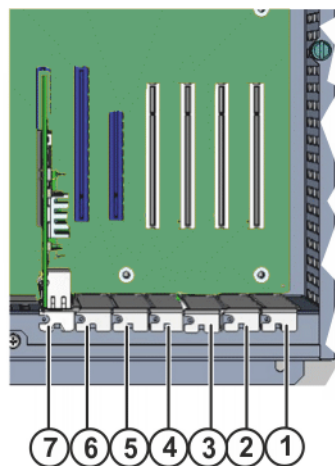

**Fig. 3-6: Motherboard D3076-K interfaces**

- 1 Field bus cards, slots 1 to 4
- 2 Cover, field bus cards
- 3 2 USB 2.0 ports
- 4 DVI-I
- 5 4 USB 2.0 ports
- 6 LAN Onboard – KUKA Option Network Interface

**i** KUKA Roboter GmbH has assembled, tested and supplied the motherboard with an optimum configuration. No liability will be accepted for modifications to the configuration that have not been carried out by KUKA Roboter GmbH.

#### Slot assignment



**Fig. 3-7: Motherboard slot assignment**

The PC slots can be fitted with the following plug-in cards:

Slot	Type	Plug-in card
1	PCI	Field bus
2	PCI	Field bus
3	PCI	Field bus
4	PCI	Field bus
5	PCIe	not available
6	PCIe	not available
7	PCIe	LAN Dual NIC network card

### 3.5.1.2 Motherboard D3236-K PC interfaces

#### Overview

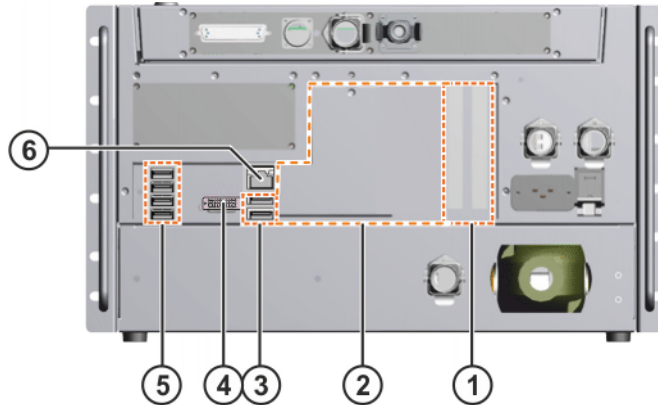
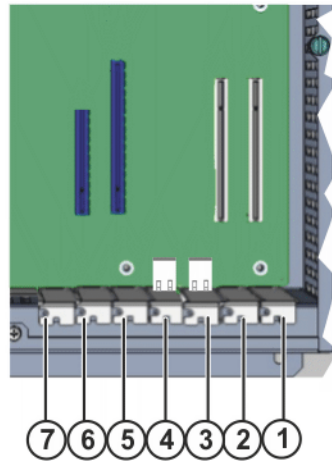

**Fig. 3-8: Motherboard D3236-K interfaces**

- 1 Field bus cards, slots 1 to 2
- 2 Cover, field bus cards
- 3 2 USB 3.0 ports
- 4 DVI-I
- 5 4 USB 2.0 ports
- 6 LAN Onboard – KUKA Option Network Interface

**i** KUKA Roboter GmbH has assembled, tested and supplied the motherboard with an optimum configuration. No liability will be accepted for modifications to the configuration that have not been carried out by KUKA Roboter GmbH.

#### Slot assignment



**Fig. 3-9: Motherboard slot assignment**

The PC slots can be fitted with the following plug-in cards:

Slot	Type	Plug-in card
1	PCI	Field bus
2	PCI	Field bus
3	-	not available
4	-	not available
5	PCIe	not available
6	PCIe	not available
7	-	not available

### 3.6 Cooling

#### Description

The components of the control and power electronics are cooled with ambient air by 2 fans.

**NOTICE** Upstream installation of filter mats at the ventilation slits causes an increase in temperature, leading to a reduction in the service life of the installed devices!

#### Cooling circuit, control box

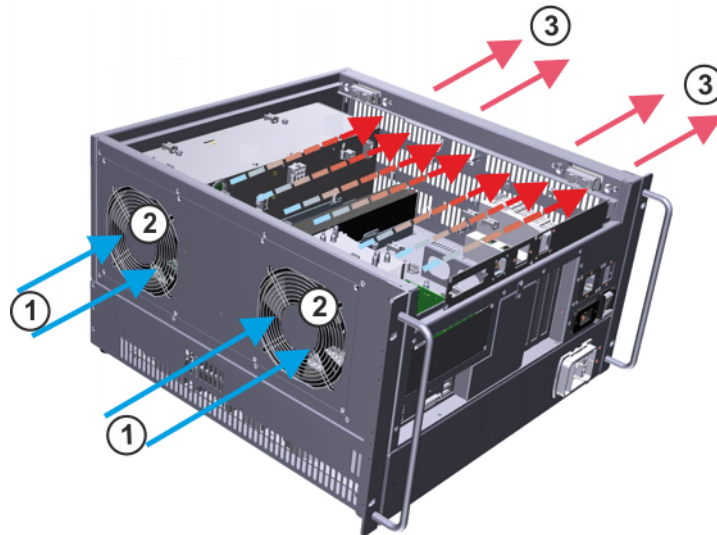

Fig. 3-10: Cooling circuit, control box

- |             |              |
|-------------|--------------|
| 1 Air inlet | 3 Air outlet |
| 2 Fans      |              |

#### Cooling circuit, drive box



Fig. 3-11: Cooling circuit, drive box

- |             |              |
|-------------|--------------|
| 1 Air inlet | 3 Air outlet |
| 2 Fans      |              |



## 4 Technical data

### Basic data

Cabinet type	19" chassis
Color	RAL 7016
Number of axes	max. 6
Weight	33 kg
Protection rating	IP 20
Sound level according to DIN 45635-1	average: 54 dB (A)

### Power supply connection

The robot controller may only be connected to grounded-neutral power supply systems.

Rated supply voltage	200 V - 230 V AC, single-phase, two-phase (with grounded neutral (as symmetrical as possible) between the phases used)
Permissible tolerance of rated supply voltage	Rated supply voltage $\pm 10\%$
Mains frequency	50 Hz $\pm 1$ Hz or 60 Hz $\pm 1$ Hz
Rated power input	2 kVA, see rating plate
Thermal power dissipation	max. 400 W
Mains-side fusing	2x 16 A slow-blowing (1 (2)x phase; 1x neutral conductor (optional))
Equipotential bonding	The common neutral point for the equipotential bonding conductors and all protective ground conductors is the reference bus of the power unit

### Environmental conditions

Ambient temperature during operation	+5 ... 45 °C (278 ... 318 K)
Ambient temperature during storage/transportation with batteries	-25 ... +40 °C (248 ... 313 K)
Ambient temperature during storage/transportation without batteries	-25 ... +70 °C (248 ... 343 K)
Temperature change	max. 1.1 K/min
Humidity class	3k3 acc. to DIN EN 60721-3-3; 1995
Altitude	<ul style="list-style-type: none"> <li>■ up to 1000 m above mean sea level with no reduction in power</li> <li>■ 1000 m ... 4000 m above mean sea level with a reduction in power of 5%/1000 m</li> </ul>

**NOTICE** To prevent exhaustive discharge and thus destruction of the batteries, the batteries must be recharged at regular intervals according to the storage temperature.  
 If the storage temperature is +20 °C or lower, the batteries must be recharged every 9 months.  
 If the storage temperature is between +20 °C and +30 °C, the batteries must be recharged every 6 months.  
 If the storage temperature is between +30 °C and +40 °C, the batteries must be recharged every 3 months.

**Vibration resistance**

Type of loading	During transportation	During continuous operation
r.m.s. acceleration (sustained oscillation)	0.37 g	0.1 g
Frequency range (sustained oscillation)	4 to 120 Hz	
Acceleration (shock in X/Y/Z direction)	10 g	2.5 g
Waveform/duration (shock in X/Y/Z direction)	Half-sine/11 ms	

If more severe mechanical stress is expected, the controller must be installed on anti-vibration components.

**Control unit**

Supply voltage	DC 27.1 V ± 0.1 V
----------------	-------------------

**Control PC**

Main processor	See shipping version
DIMM memory modules	See shipping version (min. 2 GB)
Hard disk	See shipping version

**KUKA smartPAD**

Supply voltage	20 ... 27.1 V DC
Dimensions (WxHxD)	approx. 33x26x8 cm <sup>3</sup>
Display	Touch-sensitive color display 600x800 pixels
Display size	8,4 "
Interfaces	USB
Weight	1.1 kg
Protection rating (without USB stick and USB connection closed with a plug)	IP 54

**Cable lengths**

For cable designations, standard lengths and optional lengths, please refer to the operating instructions or assembly instructions of the manipulator and/or the assembly and operating instructions for KR C4 external cabling for robot controllers.

 When using smartPAD cable extensions, only two extensions may be used. An overall cable length of 50 m must not be exceeded.

 The difference in the cable lengths between the individual channels of the RDC box must not exceed 10 m.

**4.1 Dimensions**

The dimensions of the robot controller are indicated in the diagram (>>> Fig. 4-1 ).

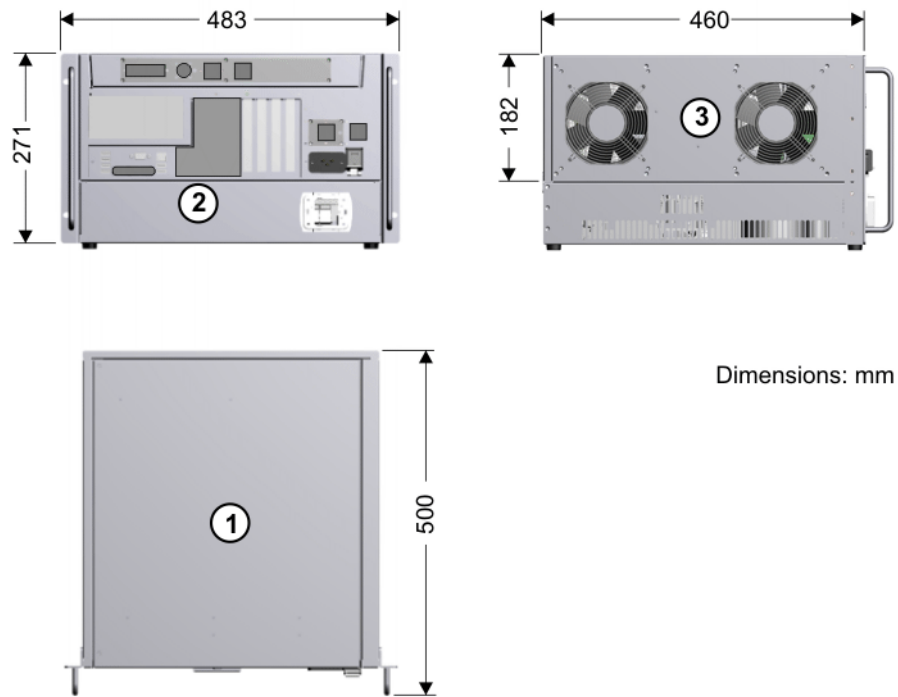

**Fig. 4-1: Dimensions**

- 1 Top view
- 2 Front view
- 3 Side view

## 4.2 Cabinet Interface Board, Small Robot

### CIB\_SR outputs

Operating voltage, power contacts	$\leq 30 \text{ V}$
Current via power contact	min. 10 mA < 750 mA
Cable lengths (connection of actuators)	< 50 m cable lengths < 100 m wire length (outgoing and incoming lines)
Cable cross-section (connection of actuators)	$\geq 1 \text{ mm}^2$
Switching cycles CIB_SR	Service life: 20 years < 100,000 (corresponds to 13 switching cycles per day)

The module must be exchanged when the number of switching cycles is exceeded.

**CIB\_SR inputs**

Switching level of the inputs	The state for the inputs is not defined for the voltage range 5 V ... 11 V (transition range). Either the ON state or the OFF state is set.  OFF state for the voltage range from -3 V to 5 V (OFF range).  ON state for the voltage range from 11 V to 30 V (ON range).
Load current with 24 V supply voltage	> 10 mA
Load current with 18 V supply voltage	> 6.5 mA
Max. load current	< 15 mA
Cable length, terminal - sensor	< 50 m, or < 100 m wire length (outgoing and incoming lines)
Cable cross-section, test output - input connection	> 0.5 mm <sup>2</sup>
Capacitive load for the test outputs per channel	< 200 nF
Resistive load for the test outputs per channel	< 33 Ω

**i** Test outputs A and B are sustained short-circuit proof. The specified currents flow via the contact element connected to the input. This must be rated for the maximum current of 15 mA.

**4.3 Dimensions of the smartPAD holder (optional)**

The diagram (>>> Fig. 4-2 ) shows the dimensions and drilling locations for mounting on the safety fence.

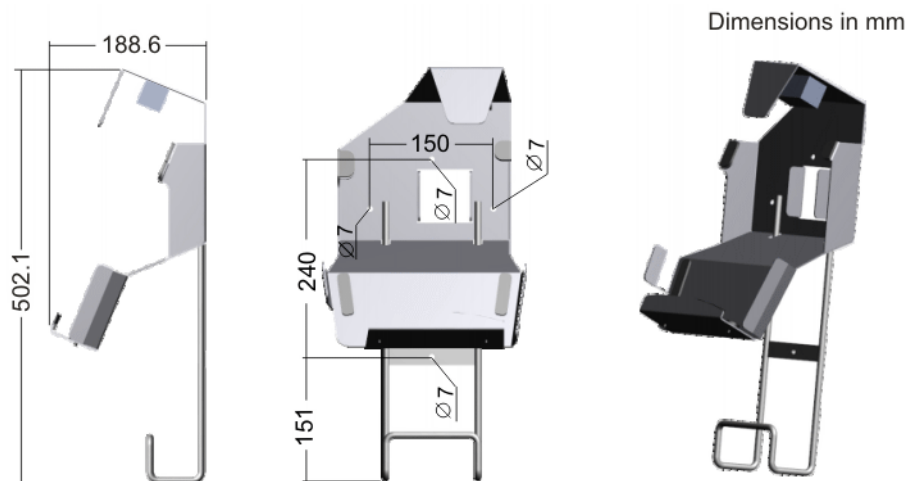

**Fig. 4-2: Dimensions and drilling locations for smartPAD holder**



#### 4.4 Dimensions of handle brackets

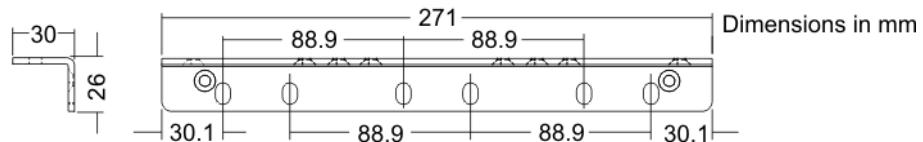

Fig. 4-3: Dimensions of handle brackets

#### 4.5 Plates and labels

##### Overview

The following plates and labels are attached to the robot controller:

##### Designations

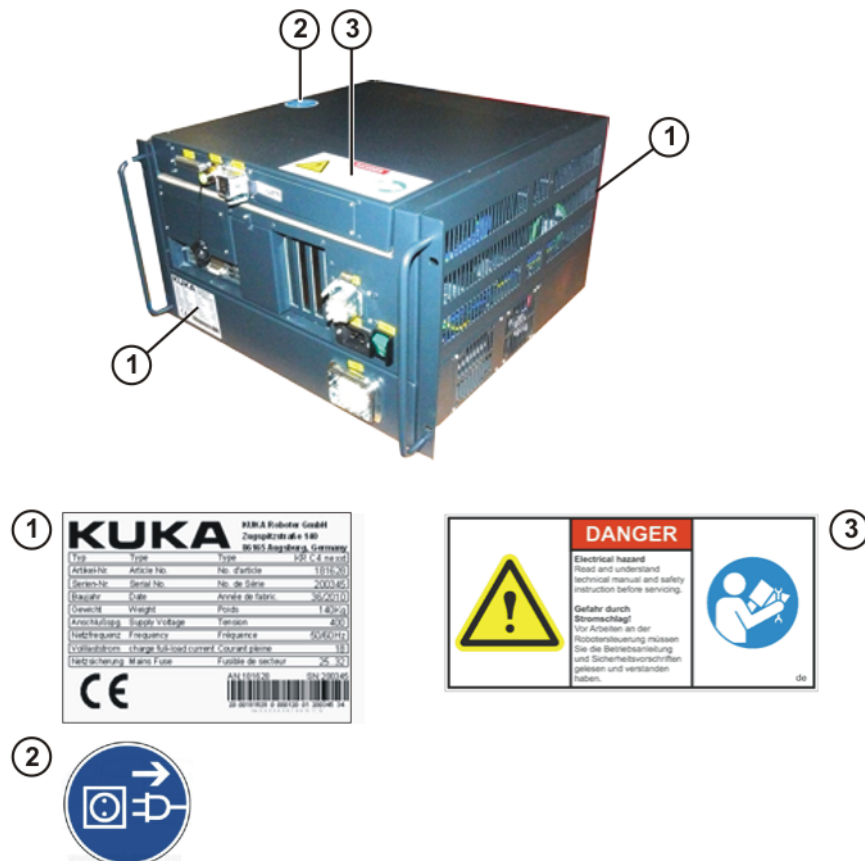

Fig. 4-4: Plates and labels

Plate no.	Designation
1	Robot controller identification plate
2	Note: unplug mains connector before opening the housing.
3	Warning: read manual



The plates may vary slightly from the examples illustrated above depending on the specific cabinet type or as a result of updates.



## 5 Safety

### 5.1 General

#### 5.1.1 Liability

The device described in this document is either an industrial robot or a component thereof.

Components of the industrial robot:

- Manipulator
- Robot controller
- Teach pendant
- Connecting cables
- External axes (optional)  
e.g. linear unit, turn-tilt table, positioner
- Software
- Options, accessories

The industrial robot is built using state-of-the-art technology and in accordance with the recognized safety rules. Nevertheless, misuse of the industrial robot may constitute a risk to life and limb or cause damage to the industrial robot and to other material property.

The industrial robot may only be used in perfect technical condition in accordance with its designated use and only by safety-conscious persons who are fully aware of the risks involved in its operation. Use of the industrial robot is subject to compliance with this document and with the declaration of incorporation supplied together with the industrial robot. Any functional disorders affecting safety must be rectified immediately.

#### Safety information

Safety information cannot be held against KUKA Roboter GmbH. Even if all safety instructions are followed, this is not a guarantee that the industrial robot will not cause personal injuries or material damage.

No modifications may be carried out to the industrial robot without the authorization of KUKA Roboter GmbH. Additional components (tools, software, etc.), not supplied by KUKA Roboter GmbH, may be integrated into the industrial robot. The user is liable for any damage these components may cause to the industrial robot or to other material property.

In addition to the Safety chapter, this document contains further safety instructions. These must also be observed.

#### 5.1.2 Intended use of the industrial robot

The industrial robot is intended exclusively for the use designated in the "Purpose" chapter of the operating instructions or assembly instructions.

Any use or application deviating from the intended use is deemed to be misuse and is not allowed. The manufacturer is not liable for any damage resulting from such misuse. The risk lies entirely with the user.

Operation of the industrial robot in accordance with its intended use also requires compliance with the operating and assembly instructions for the individual components, with particular reference to the maintenance specifications.

#### Misuse

Any use or application deviating from the intended use is deemed to be misuse and is not allowed. This includes e.g.:

- Transportation of persons and animals
- Use as a climbing aid
- Operation outside the specified operating parameters
- Use in potentially explosive environments
- Operation without additional safeguards
- Outdoor operation
- Underground operation

### 5.1.3 EC declaration of conformity and declaration of incorporation

The industrial robot constitutes partly completed machinery as defined by the EC Machinery Directive. The industrial robot may only be put into operation if the following preconditions are met:

- The industrial robot is integrated into a complete system.  
Or: The industrial robot, together with other machinery, constitutes a complete system.  
Or: All safety functions and safeguards required for operation in the complete machine as defined by the EC Machinery Directive have been added to the industrial robot.
- The complete system complies with the EC Machinery Directive. This has been confirmed by means of an assessment of conformity.

#### Declaration of conformity

The system integrator must issue a declaration of conformity for the complete system in accordance with the Machinery Directive. The declaration of conformity forms the basis for the CE mark for the system. The industrial robot must always be operated in accordance with the applicable national laws, regulations and standards.

The robot controller is CE certified under the EMC Directive and the Low Voltage Directive.

#### Declaration of incorporation

The industrial robot as partly completed machinery is supplied with a declaration of incorporation in accordance with Annex II B of the EC Machinery Directive 2006/42/EC. The assembly instructions and a list of essential requirements complied with in accordance with Annex I are integral parts of this declaration of incorporation.

The declaration of incorporation declares that the start-up of the partly completed machinery is not allowed until the partly completed machinery has been incorporated into machinery, or has been assembled with other parts to form machinery, and this machinery complies with the terms of the EC Machinery Directive, and the EC declaration of conformity is present in accordance with Annex II A.

### 5.1.4 Terms used

STOP 0, STOP 1 and STOP 2 are the stop definitions according to EN 60204-1:2006.

Term	Description
Axis range	Range of each axis, in degrees or millimeters, within which it may move. The axis range must be defined for each axis.
Stopping distance	Stopping distance = reaction distance + braking distance  The stopping distance is part of the danger zone.
Workspace	Area within which the robot may move. The workspace is derived from the individual axis ranges.

Term	Description
User	The user of the industrial robot can be the management, employer or delegated person responsible for use of the industrial robot.
Danger zone	The danger zone consists of the workspace and the stopping distances of the manipulator and external axes (optional).
Service life	The service life of a safety-relevant component begins at the time of delivery of the component to the customer.  The service life is not affected by whether the component is used or not, as safety-relevant components are also subject to aging during storage.
KUKA smartPAD	see "smartPAD"
Manipulator	The robot arm and the associated electrical installations
Safety zone	The safety zone is situated outside the danger zone.
Safe operational stop	The safe operational stop is a standstill monitoring function. It does not stop the robot motion, but monitors whether the robot axes are stationary. If these are moved during the safe operational stop, a safety stop STOP 0 is triggered.  The safe operational stop can also be triggered externally.  When a safe operational stop is triggered, the robot controller sets an output to the field bus. The output is set even if not all the axes were stationary at the time of triggering, thereby causing a safety stop STOP 0 to be triggered.
Safety STOP 0	A stop that is triggered and executed by the safety controller. The safety controller immediately switches off the drives and the power supply to the brakes.  <b>Note:</b> This stop is called safety STOP 0 in this document.
Safety STOP 1	A stop that is triggered and monitored by the safety controller. The braking process is performed by the non-safety-oriented part of the robot controller and monitored by the safety controller. As soon as the manipulator is at a standstill, the safety controller switches off the drives and the power supply to the brakes.  When a safety STOP 1 is triggered, the robot controller sets an output to the field bus.  The safety STOP 1 can also be triggered externally.  <b>Note:</b> This stop is called safety STOP 1 in this document.
Safety STOP 2	A stop that is triggered and monitored by the safety controller. The braking process is performed by the non-safety-oriented part of the robot controller and monitored by the safety controller. The drives remain activated and the brakes released. As soon as the manipulator is at a standstill, a safe operational stop is triggered.  When a safety STOP 2 is triggered, the robot controller sets an output to the field bus.  The safety STOP 2 can also be triggered externally.  <b>Note:</b> This stop is called safety STOP 2 in this document.
Safety options	Generic term for options which make it possible to configure additional safe monitoring functions in addition to the standard safety functions.  Example: SafeOperation
smartPAD	Teach pendant for the KR C4  The smartPAD has all the operator control and display functions required for operating and programming the industrial robot.

Term	Description
Stop category 0	The drives are deactivated immediately and the brakes are applied. The manipulator and any external axes (optional) perform path-oriented braking. <b>Note:</b> This stop category is called STOP 0 in this document.
Stop category 1	The manipulator and any external axes (optional) perform path-maintaining braking. <ul style="list-style-type: none"> <li>■ Operating mode T1: The drives are deactivated as soon as the robot has stopped, but no later than after 680 ms.</li> <li>■ Operating mode T2, AUT, AUT EXT: The drives are switched off after 1.5 s.</li> </ul> <b>Note:</b> This stop category is called STOP 1 in this document.
Stop category 2	The drives are not deactivated and the brakes are not applied. The manipulator and any external axes (optional) are braked with a path-maintaining braking ramp. <b>Note:</b> This stop category is called STOP 2 in this document.
System integrator (plant integrator)	The system integrator is responsible for safely integrating the industrial robot into a complete system and commissioning it.
T1	Test mode, Manual Reduced Velocity ( $\leq 250$ mm/s)
T2	Test mode, Manual High Velocity ( $> 250$ mm/s permissible)
External axis	Motion axis which is not part of the manipulator but which is controlled using the robot controller, e.g. KUKA linear unit, turn-tilt table, Posiflex.

## 5.2 Personnel

The following persons or groups of persons are defined for the industrial robot:

- User
- Personnel



All persons working with the industrial robot must have read and understood the industrial robot documentation, including the safety chapter.

### User

The user must observe the labor laws and regulations. This includes e.g.:

- The user must comply with his monitoring obligations.
- The user must carry out instructions at defined intervals.

### Personnel

Personnel must be instructed, before any work is commenced, in the type of work involved and what exactly it entails as well as any hazards which may exist. Instruction must be carried out regularly. Instruction is also required after particular incidents or technical modifications.

Personnel includes:

- System integrator
- Operators, subdivided into:
  - Start-up, maintenance and service personnel
  - Operating personnel
  - Cleaning personnel



Installation, exchange, adjustment, operation, maintenance and repair must be performed only as specified in the operating or assembly instructions for the relevant component of the industrial robot and only by personnel specially trained for this purpose.

**System integrator** The industrial robot is safely integrated into a complete system by the system integrator.

The system integrator is responsible for the following tasks:

- Installing the industrial robot
- Connecting the industrial robot
- Performing risk assessment
- Implementing the required safety functions and safeguards
- Issuing the declaration of conformity
- Attaching the CE mark
- Creating the operating instructions for the complete system

**Operator**

The operator must meet the following preconditions:

- The operator must be trained for the work to be carried out.
- Work on the industrial robot must only be carried out by qualified personnel. These are people who, due to their specialist training, knowledge and experience, and their familiarization with the relevant standards, are able to assess the work to be carried out and detect any potential hazards.



Work on the electrical and mechanical equipment of the industrial robot may only be carried out by specially trained personnel.

### 5.3 Workspace, safety zone and danger zone

Workspaces are to be restricted to the necessary minimum size. A workspace must be safeguarded using appropriate safeguards.

The safeguards (e.g. safety gate) must be situated inside the safety zone. In the case of a stop, the manipulator and external axes (optional) are braked and come to a stop within the danger zone.

The danger zone consists of the workspace and the stopping distances of the manipulator and external axes (optional). It must be safeguarded by means of physical safeguards to prevent danger to persons or the risk of material damage.

### 5.4 Triggers for stop reactions

Stop reactions of the industrial robot are triggered in response to operator actions or as a reaction to monitoring functions and error messages. The following table shows the different stop reactions according to the operating mode that has been set.

Trigger	T1, T2	AUT, AUT EXT
Start key released	STOP 2	-
STOP key pressed	STOP 2	
Drives OFF	STOP 1	
“Motion enable” input drops out	STOP 2	
Power switched off via main switch or power failure	STOP 0	
Internal error in non-safety-oriented part of the robot controller	STOP 0 or STOP 1 (dependent on the cause of the error)	

Trigger	T1, T2	AUT, AUT EXT
Operating mode changed during operation	Safety stop 2	
Safety gate opened (operator safety)	-	Safety stop 1
Enabling switch released	Safety stop 2	-
Enabling switch pressed fully down or error	Safety stop 1	-
E-STOP pressed	Safety stop 1	
Error in safety controller or periphery of the safety controller	Safety stop 0	

## 5.5 Safety functions

### 5.5.1 Overview of the safety functions

The following safety functions are present in the industrial robot:

- Mode selection
- Operator safety (= connection for the guard interlock)
- EMERGENCY STOP device
- Enabling device
- External safe operational stop
- External safety stop 1 (not for the controller variant "KR C4 compact")
- External safety stop 2
- Velocity monitoring in T1

The safety functions of the industrial robot meet the following requirements:

- **Category 3** and **Performance Level d** in accordance with EN ISO 13849-1:2008

The requirements are only met on the following condition, however:

- The EMERGENCY STOP device is pressed at least once every 6 months.

The following components are involved in the safety functions:

- Safety controller in the control PC
- KUKA smartPAD
- Cabinet Control Unit (CCU)
- Resolver Digital Converter (RDC)
- KUKA Power Pack (KPP)
- KUKA Servo Pack (KSP)
- Safety Interface Board (SIB) (if used)

There are also interfaces to components outside the industrial robot and to other robot controllers.



**DANGER** In the absence of operational safety functions and safeguards, the industrial robot can cause personal injury or material damage. If safety functions or safeguards are dismantled or deactivated, the industrial robot may not be operated.





During system planning, the safety functions of the overall system must also be planned and designed. The industrial robot must be integrated into this safety system of the overall system.

### 5.5.2 Safety controller

The safety controller is a unit inside the control PC. It links safety-relevant signals and safety-relevant monitoring functions.

Safety controller tasks:

- Switching off the drives; applying the brakes
- Monitoring the braking ramp
- Standstill monitoring (after the stop)
- Velocity monitoring in T1
- Evaluation of safety-relevant signals
- Setting of safety-oriented outputs

### 5.5.3 Mode selection

The industrial robot can be operated in the following modes:

- Manual Reduced Velocity (T1)
- Manual High Velocity (T2)
- Automatic (AUT)
- Automatic External (AUT EXT)



Do not change the operating mode while a program is running. If the operating mode is changed during program execution, the industrial robot is stopped with a safety stop 2.

Operating mode	Use	Velocities
T1	For test operation, programming and teaching	<ul style="list-style-type: none"> <li>■ Program verification: Programmed velocity, maximum 250 mm/s</li> <li>■ Manual mode: Jog velocity, maximum 250 mm/s</li> </ul>
T2	For test operation	<ul style="list-style-type: none"> <li>■ Program verification: Programmed velocity</li> <li>■ Manual mode: Not possible</li> </ul>
AUT	For industrial robots without higher-level controllers	<ul style="list-style-type: none"> <li>■ Program mode: Programmed velocity</li> <li>■ Manual mode: Not possible</li> </ul>
AUT EXT	For industrial robots with higher-level controllers, e.g. PLC	<ul style="list-style-type: none"> <li>■ Program mode: Programmed velocity</li> <li>■ Manual mode: Not possible</li> </ul>

### 5.5.4 “Operator safety” signal

The “operator safety” signal is used for interlocking physical safeguards, e.g. safety gates. Automatic operation is not possible without this signal. In the

event of a loss of signal during automatic operation (e.g. safety gate is opened), the manipulator stops with a safety stop 1.

Operator safety is not active in modes T1 (Manual Reduced Velocity) and T2 (Manual High Velocity).

**⚠ WARNING** Following a loss of signal, automatic operation may only be resumed when the safeguard has been closed and when the closing has been acknowledged. This acknowledgement is to prevent automatic operation from being resumed inadvertently while there are still persons in the danger zone, e.g. due to the safety gate closing accidentally. The acknowledgement must be designed in such a way that an actual check of the danger zone can be carried out first. Other acknowledgement functions (e.g. an acknowledgement which is automatically triggered by closure of the safeguard) are not permitted. The system integrator is responsible for ensuring that these criteria are met. Failure to meet them may result in death, severe injuries or considerable damage to property.

### 5.5.5 EMERGENCY STOP device

The EMERGENCY STOP device for the industrial robot is the EMERGENCY STOP device on the smartPAD. The device must be pressed in the event of a hazardous situation or emergency.

Reactions of the industrial robot if the EMERGENCY STOP device is pressed:

- The manipulator and any external axes (optional) are stopped with a safety stop 1.

Before operation can be resumed, the EMERGENCY STOP device must be turned to release it.

**⚠ WARNING** Tools and other equipment connected to the manipulator must be integrated into the EMERGENCY STOP circuit on the system side if they could constitute a potential hazard. Failure to observe this precaution may result in death, severe injuries or considerable damage to property.

There must always be at least one external EMERGENCY STOP device installed. This ensures that an EMERGENCY STOP device is available even when the smartPAD is disconnected.

(>>> 5.5.7 "External EMERGENCY STOP device" Page 35)

### 5.5.6 Logging off from the higher-level safety controller

If the robot controller is connected to a higher-level safety controller, this connection will inevitably be terminated in the following cases:

- Switching off the voltage via the main switch of the robot  
Or power failure
- Shutdown of the robot controller via the smartHMI
- Activation of a WorkVisual project in WorkVisual or directly on the robot controller
- Changes to **Start-up > Network configuration**
- Changes to **Configuration > Safety configuration**
- **I/O drivers > Reconfigure**
- Restoration of an archive

Effect of the interruption:

- If a discrete safety interface is used, this triggers an EMERGENCY STOP for the overall system.
- If the Ethernet interface is used, the KUKA safety controller generates a signal that prevents the higher-level controller from triggering an EMERGENCY STOP for the overall system.



If the Ethernet safety interface is used: In his risk assessment, the system integrator must take into consideration whether the fact that switching off the robot controller does not trigger an EMERGENCY STOP of the overall system could constitute a hazard and, if so, how this hazard can be countered.  
Failure to take this into consideration may result in death, injuries or damage to property.



If a robot controller is switched off, the E-STOP device on the smartPAD is no longer functional. The user is responsible for ensuring that the smartPAD is either covered or removed from the system. This serves to prevent operational and non-operational EMERGENCY STOP devices from becoming interchanged.  
Failure to observe this precaution may result in death, injuries or damage to property.

### 5.5.7 External EMERGENCY STOP device

Every operator station that can initiate a robot motion or other potentially hazardous situation must be equipped with an EMERGENCY STOP device. The system integrator is responsible for ensuring this.

There must always be at least one external EMERGENCY STOP device installed. This ensures that an EMERGENCY STOP device is available even when the smartPAD is disconnected.

External EMERGENCY STOP devices are connected via the customer interface. External EMERGENCY STOP devices are not included in the scope of supply of the industrial robot.

### 5.5.8 Enabling device

The enabling devices of the industrial robot are the enabling switches on the smartPAD.

There are 3 enabling switches installed on the smartPAD. The enabling switches have 3 positions:

- Not pressed
- Center position
- Panic position

In the test modes, the manipulator can only be moved if one of the enabling switches is held in the central position.

- Releasing the enabling switch triggers a safety stop 2.
- Pressing the enabling switch down fully (panic position) triggers a safety stop 1.
- It is possible to hold 2 enabling switches in the center position simultaneously for up to 15 seconds. This makes it possible to adjust grip from one enabling switch to another one. If 2 enabling switches are held simultaneously in the center position for longer than 15 seconds, this triggers a safety stop 1.

If an enabling switch malfunctions (jams), the industrial robot can be stopped using the following methods:

- Press the enabling switch down fully
- Actuate the EMERGENCY STOP system
- Release the Start key

**WARNING**

The enabling switches must not be held down by adhesive tape or other means or tampered with in any other way.  
Death, injuries or damage to property may result.

### 5.5.9 External enabling device

External enabling devices are required if it is necessary for more than one person to be in the danger zone of the industrial robot.

External enabling devices are not included in the scope of supply of the industrial robot.



Which interface can be used for connecting external enabling devices is described in the "Planning" chapter of the robot controller operating instructions and assembly instructions.

### 5.5.10 External safe operational stop

The safe operational stop can be triggered via an input on the customer interface. The state is maintained as long as the external signal is FALSE. If the external signal is TRUE, the manipulator can be moved again. No acknowledgement is required.

### 5.5.11 External safety stop 1 and external safety stop 2

Safety stop 1 and safety stop 2 can be triggered via an input on the customer interface. The state is maintained as long as the external signal is FALSE. If the external signal is TRUE, the manipulator can be moved again. No acknowledgement is required.



No external safety stop 1 is available for the controller variant "KR C4 compact".

### 5.5.12 Velocity monitoring in T1

The velocity at the TCP is monitored in T1 mode. If the velocity exceeds 250 mm/s, a safety stop 0 is triggered.

## 5.6 Additional protective equipment

### 5.6.1 Jog mode

In the operating modes T1 (Manual Reduced Velocity) and T2 (Manual High Velocity), the robot controller can only execute programs in jog mode. This means that it is necessary to hold down an enabling switch and the Start key in order to execute a program.

- Releasing the enabling switch triggers a safety stop 2.

- Pressing the enabling switch down fully (panic position) triggers a safety stop 1.
- Releasing the Start key triggers a STOP 2.

### 5.6.2 Software limit switches

The axis ranges of all manipulator and positioner axes are limited by means of adjustable software limit switches. These software limit switches only serve as machine protection and must be adjusted in such a way that the manipulator/positioner cannot hit the mechanical end stops.

The software limit switches are set during commissioning of an industrial robot.

 Further information is contained in the operating and programming instructions.

### 5.6.3 Mechanical end stops

Depending on the robot variant, the axis ranges of the main and wrist axes of the manipulator are partially limited by mechanical end stops.

Additional mechanical end stops can be installed on the external axes.

 **WARNING** If the manipulator or an external axis hits an obstruction or a mechanical end stop or axis range limitation, the manipulator can no longer be operated safely. The manipulator must be taken out of operation and KUKA Roboter GmbH must be consulted before it is put back into operation (>>> 14 "KUKA Service" Page 111).

### 5.6.4 Mechanical axis range limitation (optional)

Some manipulators can be fitted with mechanical axis range limitation in axes A1 to A3. The adjustable axis range limitation systems restrict the working range to the required minimum. This increases personal safety and protection of the system.

In the case of manipulators that are not designed to be fitted with mechanical axis range limitation, the workspace must be laid out in such a way that there is no danger to persons or material property, even in the absence of mechanical axis range limitation.

If this is not possible, the workspace must be limited by means of photoelectric barriers, photoelectric curtains or obstacles on the system side. There must be no shearing or crushing hazards at the loading and transfer areas.

 This option is not available for all robot models. Information on specific robot models can be obtained from KUKA Roboter GmbH.

### 5.6.5 Axis range monitoring (optional)

Some manipulators can be fitted with dual-channel axis range monitoring systems in main axes A1 to A3. The positioner axes may be fitted with additional axis range monitoring systems. The safety zone for an axis can be adjusted and monitored using an axis range monitoring system. This increases personal safety and protection of the system.



This option is not available for all robot models. Information on specific robot models can be obtained from KUKA Roboter GmbH.

### 5.6.6 Options for moving the manipulator without drive energy



The system user is responsible for ensuring that the training of personnel with regard to the response to emergencies or exceptional situations also includes how the manipulator can be moved without drive energy.

#### Description

The following options are available for moving the manipulator without drive energy after an accident or malfunction:

- Release device (optional)  
The release device can be used for the main axis drive motors and, depending on the robot variant, also for the wrist axis drive motors.
- Brake release device (option)  
The brake release device is designed for robot variants whose motors are not freely accessible.
- Moving the wrist axes directly by hand  
There is no release device available for the wrist axes of variants in the low payload category. This is not necessary because the wrist axes can be moved directly by hand.



Information about the options available for the various robot models and about how to use them can be found in the assembly and operating instructions for the robot or requested from KUKA Roboter GmbH.

#### NOTICE

Moving the manipulator without drive energy can damage the motor brakes of the axes concerned. The motor must be replaced if the brake has been damaged. The manipulator may therefore be moved without drive energy only in emergencies, e.g. for rescuing persons.

### 5.6.7 Labeling on the industrial robot

All plates, labels, symbols and marks constitute safety-relevant parts of the industrial robot. They must not be modified or removed.

Labeling on the industrial robot consists of:

- Identification plates
- Warning signs
- Safety symbols
- Designation labels
- Cable markings
- Rating plates



Further information is contained in the technical data of the operating instructions or assembly instructions of the components of the industrial robot.

### 5.6.8 External safeguards

The access of persons to the danger zone of the industrial robot must be prevented by means of safeguards. It is the responsibility of the system integrator to ensure this.

Physical safeguards must meet the following requirements:

- They meet the requirements of EN 953.
- They prevent access of persons to the danger zone and cannot be easily circumvented.
- They are sufficiently fastened and can withstand all forces that are likely to occur in the course of operation, whether from inside or outside the enclosure.
- They do not, themselves, represent a hazard or potential hazard.
- The prescribed minimum clearance from the danger zone is maintained.

Safety gates (maintenance gates) must meet the following requirements:

- They are reduced to an absolute minimum.
- The interlocks (e.g. safety gate switches) are linked to the operator safety input of the robot controller via safety gate switching devices or safety PLC.
- Switching devices, switches and the type of switching conform to the requirements of Performance Level d and category 3 according to EN ISO 13849-1.
- Depending on the risk situation: the safety gate is additionally safeguarded by means of a locking mechanism that only allows the gate to be opened if the manipulator is safely at a standstill.
- The button for acknowledging the safety gate is located outside the space limited by the safeguards.



Further information is contained in the corresponding standards and regulations. These also include EN 953.

#### Other safety equipment

Other safety equipment must be integrated into the system in accordance with the corresponding standards and regulations.

### 5.7 Overview of operating modes and safety functions

The following table indicates the operating modes in which the safety functions are active.

Safety functions	T1	T2	AUT	AUT EXT
Operator safety	-	-	active	active
EMERGENCY STOP device	active	active	active	active
Enabling device	active	active	-	-
Reduced velocity during program verification	active	-	-	-
Jog mode	active	active	-	-
Software limit switches	active	active	active	active

## 5.8 Safety measures

### 5.8.1 General safety measures

The industrial robot may only be used in perfect technical condition in accordance with its intended use and only by safety-conscious persons. Operator errors can result in personal injury and damage to property.

It is important to be prepared for possible movements of the industrial robot even after the robot controller has been switched off and locked out. Incorrect installation (e.g. overload) or mechanical defects (e.g. brake defect) can cause the manipulator or external axes to sag. If work is to be carried out on a switched-off industrial robot, the manipulator and external axes must first be moved into a position in which they are unable to move on their own, whether the payload is mounted or not. If this is not possible, the manipulator and external axes must be secured by appropriate means.

 **DANGER** In the absence of operational safety functions and safeguards, the industrial robot can cause personal injury or material damage. If safety functions or safeguards are dismantled or deactivated, the industrial robot may not be operated.

 **DANGER** Standing underneath the robot arm can cause death or injuries. For this reason, standing underneath the robot arm is prohibited!

 **CAUTION** The motors reach temperatures during operation which can cause burns to the skin. Contact must be avoided. Appropriate safety precautions must be taken, e.g. protective gloves must be worn.

#### smartPAD

The user must ensure that the industrial robot is only operated with the smartPAD by authorized persons.

If more than one smartPAD is used in the overall system, it must be ensured that each smartPAD is unambiguously assigned to the corresponding industrial robot. They must not be interchanged.

 **WARNING** The operator must ensure that decoupled smartPADs are immediately removed from the system and stored out of sight and reach of personnel working on the industrial robot. This serves to prevent operational and non-operational EMERGENCY STOP devices from becoming interchanged. Failure to observe this precaution may result in death, severe injuries or considerable damage to property.

#### Modifications

After modifications to the industrial robot, checks must be carried out to ensure the required safety level. The valid national or regional work safety regulations must be observed for this check. The correct functioning of all safety functions must also be tested.

New or modified programs must always be tested first in Manual Reduced Velocity mode (T1).

After modifications to the industrial robot, existing programs must always be tested first in Manual Reduced Velocity mode (T1). This applies to all components of the industrial robot and includes modifications to the software and configuration settings.

#### Faults

The following tasks must be carried out in the case of faults in the industrial robot:



- Switch off the robot controller and secure it (e.g. with a padlock) to prevent unauthorized persons from switching it on again.
- Indicate the fault by means of a label with a corresponding warning (tag-out).
- Keep a record of the faults.
- Eliminate the fault and carry out a function test.

## 5.8.2 Transportation

**Manipulator** The prescribed transport position of the manipulator must be observed. Transportation must be carried out in accordance with the operating instructions or assembly instructions of the robot.

Avoid vibrations and impacts during transportation in order to prevent damage to the manipulator.

**Robot controller** The prescribed transport position of the robot controller must be observed. Transportation must be carried out in accordance with the operating instructions or assembly instructions of the robot controller.

Avoid vibrations and impacts during transportation in order to prevent damage to the robot controller.

**External axis (optional)** The prescribed transport position of the external axis (e.g. KUKA linear unit, turn-tilt table, positioner) must be observed. Transportation must be carried out in accordance with the operating instructions or assembly instructions of the external axis.

## 5.8.3 Start-up and recommissioning

Before starting up systems and devices for the first time, a check must be carried out to ensure that the systems and devices are complete and operational, that they can be operated safely and that any damage is detected.

The valid national or regional work safety regulations must be observed for this check. The correct functioning of all safety functions must also be tested.



The passwords for the user groups must be changed in the KUKA System Software before start-up. The passwords must only be communicated to authorized personnel.



The robot controller is preconfigured for the specific industrial robot. If cables are interchanged, the manipulator and the external axes (optional) may receive incorrect data and can thus cause personal injury or material damage. If a system consists of more than one manipulator, always connect the connecting cables to the manipulators and their corresponding robot controllers.



If additional components (e.g. cables), which are not part of the scope of supply of KUKA Roboter GmbH, are integrated into the industrial robot, the user is responsible for ensuring that these components do not adversely affect or disable safety functions.

### NOTICE

If the internal cabinet temperature of the robot controller differs greatly from the ambient temperature, condensation can form, which may cause damage to the electrical components. Do not put the robot controller into operation until the internal temperature of the cabinet has adjusted to the ambient temperature.

**Function test**

The following tests must be carried out before start-up and recommissioning:

**General test:**

It must be ensured that:

- The industrial robot is correctly installed and fastened in accordance with the specifications in the documentation.
- There are no foreign bodies or loose parts on the industrial robot.
- All required safety equipment is correctly installed and operational.
- The power supply ratings of the industrial robot correspond to the local supply voltage and mains type.
- The ground conductor and the equipotential bonding cable are sufficiently rated and correctly connected.
- The connecting cables are correctly connected and the connectors are locked.

**Test of the safety functions:**

A function test must be carried out for the following safety functions to ensure that they are functioning correctly:

- Local EMERGENCY STOP device
- External EMERGENCY STOP device (input and output)
- Enabling device (in the test modes)
- Operator safety
- All other safety-relevant inputs and outputs used
- Other external safety functions

**5.8.3.1 Checking machine data and safety configuration**

**WARNING** The industrial robot must not be moved if incorrect machine data or an incorrect controller configuration are loaded. Death, severe injuries or considerable damage to property may otherwise result. The correct data must be loaded.

- It must be ensured that the rating plate on the robot controller has the same machine data as those entered in the declaration of incorporation. The machine data on the rating plate of the manipulator and the external axes (optional) must be entered during start-up.
- The practical tests for the machine data must be carried out within the scope of the start-up procedure.
- Following modifications to the machine data, the safety configuration must be checked.
- After activation of a WorkVisual project on the robot controller, the safety configuration must be checked!
- If machine data are adopted when checking the safety configuration (regardless of the reason for the safety configuration check), the practical tests for the machine data must be carried out.
- System Software 8.3 or higher: If the checksum of the safety configuration has changed, the safe axis monitoring functions must be checked.



Information about checking the safety configuration and the safe axis monitoring functions is contained in the Operating and Programming Instructions for System Integrators.

If the practical tests are not successfully completed in the initial start-up, KUKA Roboter GmbH must be contacted.

If the practical tests are not successfully completed during a different procedure, the machine data and the safety-relevant controller configuration must be checked and corrected.

### General practical test

If practical tests are required for the machine data, this test must always be carried out.

The following methods are available for performing the practical test:

- TCP calibration with the XYZ 4-point method

The practical test is passed if the TCP has been successfully calibrated.

Or:

1. Align the TCP with a freely selected point.  
The point serves as a reference point. It must be located so that reorientation is possible.
2. Move the TCP manually at least 45° once in each of the A, B and C directions.

The movements do not have to be accumulative, i.e. after motion in one direction it is possible to return to the original position before moving in the next direction.

The practical test is passed if the TCP does not deviate from the reference point by more than 2 cm in total.

### Practical test for axes that are not mathematically coupled

If practical tests are required for the machine data, this test must be carried out when axes are present that are not mathematically coupled.

1. Mark the starting position of the axis that is not mathematically coupled.
2. Move the axis manually by a freely selected path length. Determine the path length from the display **Actual position** on the smartHMI.
  - Move linear axes a specific distance.
  - Move rotational axes through a specific angle.
3. Measure the length of the path covered and compare it with the value displayed on the smartHMI.

The practical test is passed if the values differ by no more than 10%.

4. Repeat the test for each axis that is not mathematically coupled.

### Practical test for couplable axes

If practical tests are required for the machine data, this test must be carried out when axes are present that can be physically coupled and uncoupled, e.g. a servo gun.

1. Physically uncouple the couplable axis.
2. Move all the remaining axes individually.

The practical test is passed if it has been possible to move all the remaining axes.

## 5.8.3.2 Start-up mode

### Description

The industrial robot can be set to Start-up mode via the smartHMI user interface. In this mode, the manipulator can be moved in T1 without the external safeguards being put into operation.

When Start-up mode is possible depends on the safety interface that is used.

**If a discrete safety interface is used:**

- System Software 8.2 or earlier:

Start-up mode is always possible if all input signals at the discrete safety interface have the state "logic zero". If this is not the case, the robot controller prevents or terminates Start-up mode.

If an additional discrete safety interface for safety options is used, the inputs there must also have the state "logic zero".

- System Software 8.3:

Start-up mode is always possible. This also means that it is independent of the state of the inputs at the discrete safety interface.

If an additional discrete safety interface for safety options is used: the states of these inputs are not relevant either.

#### **If the Ethernet safety interface is used:**

The robot controller prevents or terminates Start-up mode if a connection to a higher-level safety system exists or is established.

### **Hazards**

Possible hazards and risks involved in using Start-up mode:

- A person walks into the manipulator's danger zone.
- In a hazardous situation, a disabled external EMERGENCY STOP device is actuated and the manipulator is not shut down.

Additional measures for avoiding risks in Start-up mode:

- Cover disabled EMERGENCY STOP devices or attach a warning sign indicating that the EMERGENCY STOP device is out of operation.
- If there is no safety fence, other measures must be taken to prevent persons from entering the manipulator's danger zone, e.g. use of warning tape.

### **Use**

Intended use of Start-up mode:

- Start-up in T1 mode when the external safeguards have not yet been installed or put into operation. The danger zone must be delimited at least by means of warning tape.
- Fault localization (periphery fault).
- Use of Start-up mode must be minimized as much as possible.



#### **WARNING**

Use of Start-up mode disables all external safeguards. The service personnel are responsible for ensuring that there is no-one in or near the danger zone of the manipulator as long as the safeguards are disabled. Failure to observe this precaution may result in death, injuries or damage to property.

### **Misuse**

Any use or application deviating from the intended use is deemed to be misuse and is not allowed. KUKA Roboter GmbH is not liable for any damage resulting from such misuse. The risk lies entirely with the user.

## **5.8.4 Manual mode**

Manual mode is the mode for setup work. Setup work is all the tasks that have to be carried out on the industrial robot to enable automatic operation. Setup work includes:

- Jog mode
- Teaching
- Programming
- Program verification

The following must be taken into consideration in manual mode:

- New or modified programs must always be tested first in Manual Reduced Velocity mode (T1).
- The manipulator, tooling or external axes (optional) must never touch or project beyond the safety fence.
- Workpieces, tooling and other objects must not become jammed as a result of the industrial robot motion, nor must they lead to short-circuits or be liable to fall off.
- All setup work must be carried out, where possible, from outside the safeguarded area.

If the setup work has to be carried out inside the safeguarded area, the following must be taken into consideration:

#### In **Manual Reduced Velocity mode (T1)**:

- If it can be avoided, there must be no other persons inside the safeguarded area.

If it is necessary for there to be several persons inside the safeguarded area, the following must be observed:

- Each person must have an enabling device.
- All persons must have an unimpeded view of the industrial robot.
- Eye-contact between all persons must be possible at all times.
- The operator must be so positioned that he can see into the danger area and get out of harm's way.

#### In **Manual High Velocity mode (T2)**:

- This mode may only be used if the application requires a test at a velocity higher than Manual Reduced Velocity.
- Teaching and programming are not permissible in this operating mode.
- Before commencing the test, the operator must ensure that the enabling devices are operational.
- The operator must be positioned outside the danger zone.
- There must be no other persons inside the safeguarded area. It is the responsibility of the operator to ensure this.

### 5.8.5 Simulation

Simulation programs do not correspond exactly to reality. Robot programs created in simulation programs must be tested in the system in **Manual Reduced Velocity mode (T1)**. It may be necessary to modify the program.

### 5.8.6 Automatic mode

Automatic mode is only permissible in compliance with the following safety measures:

- All safety equipment and safeguards are present and operational.
- There are no persons in the system.
- The defined working procedures are adhered to.

If the manipulator or an external axis (optional) comes to a standstill for no apparent reason, the danger zone must not be entered until an EMERGENCY STOP has been triggered.

### 5.8.7 Maintenance and repair

After maintenance and repair work, checks must be carried out to ensure the required safety level. The valid national or regional work safety regulations must be observed for this check. The correct functioning of all safety functions must also be tested.

The purpose of maintenance and repair work is to ensure that the system is kept operational or, in the event of a fault, to return the system to an operational state. Repair work includes troubleshooting in addition to the actual repair itself.

The following safety measures must be carried out when working on the industrial robot:

- Carry out work outside the danger zone. If work inside the danger zone is necessary, the user must define additional safety measures to ensure the safe protection of personnel.
- Switch off the industrial robot and secure it (e.g. with a padlock) to prevent it from being switched on again. If it is necessary to carry out work with the robot controller switched on, the user must define additional safety measures to ensure the safe protection of personnel.
- If it is necessary to carry out work with the robot controller switched on, this may only be done in operating mode T1.
- Label the system with a sign indicating that work is in progress. This sign must remain in place, even during temporary interruptions to the work.
- The EMERGENCY STOP systems must remain active. If safety functions or safeguards are deactivated during maintenance or repair work, they must be reactivated immediately after the work is completed.

 **DANGER** Before work is commenced on live parts of the robot system, the main switch must be turned off and secured against being switched on again. The system must then be checked to ensure that it is deenergized. It is not sufficient, before commencing work on live parts, to execute an EMERGENCY STOP or a safety stop, or to switch off the drives, as this does not disconnect the robot system from the mains power supply. Parts remain energized. Death or severe injuries may result.

Faulty components must be replaced using new components with the same article numbers or equivalent components approved by KUKA Roboter GmbH for this purpose.

Cleaning and preventive maintenance work is to be carried out in accordance with the operating instructions.

#### Robot controller

Even when the robot controller is switched off, parts connected to peripheral devices may still carry voltage. The external power sources must therefore be switched off if work is to be carried out on the robot controller.

The ESD regulations must be adhered to when working on components in the robot controller.

Voltages in excess of 50 V (up to 780 V) can be present in various components for several minutes after the robot controller has been switched off! To prevent life-threatening injuries, no work may be carried out on the industrial robot in this time.

Water and dust must be prevented from entering the robot controller.

#### Counterbalancing system

Some robot variants are equipped with a hydropneumatic, spring or gas cylinder counterbalancing system.

The hydropneumatic and gas cylinder counterbalancing systems are pressure equipment and, as such, are subject to obligatory equipment monitoring and the provisions of the Pressure Equipment Directive.

The user must comply with the applicable national laws, regulations and standards pertaining to pressure equipment.

Inspection intervals in Germany in accordance with Industrial Safety Order, Sections 14 and 15. Inspection by the user before commissioning at the installation site.

The following safety measures must be carried out when working on the counterbalancing system:

- The manipulator assemblies supported by the counterbalancing systems must be secured.
- Work on the counterbalancing systems must only be carried out by qualified personnel.

#### Hazardous substances

The following safety measures must be carried out when handling hazardous substances:

- Avoid prolonged and repeated intensive contact with the skin.
- Avoid breathing in oil spray or vapors.
- Clean skin and apply skin cream.



To ensure safe use of our products, we recommend that our customers regularly request up-to-date safety data sheets from the manufacturers of hazardous substances.

#### 5.8.8 Decommissioning, storage and disposal

The industrial robot must be decommissioned, stored and disposed of in accordance with the applicable national laws, regulations and standards.

#### 5.8.9 Safety measures for “single point of control”

##### Overview

If certain components in the industrial robot are operated, safety measures must be taken to ensure complete implementation of the principle of “single point of control” (SPOC).

The relevant components are:

- Submit interpreter
- PLC
- OPC server
- Remote control tools
- Tools for configuration of bus systems with online functionality
- KUKA.RobotSensorInterface



The implementation of additional safety measures may be required. This must be clarified for each specific application; this is the responsibility of the system integrator, programmer or user of the system.

Since only the system integrator knows the safe states of actuators in the periphery of the robot controller, it is his task to set these actuators to a safe state, e.g. in the event of an EMERGENCY STOP.

##### T1, T2

In modes T1 and T2, the components referred to above may only access the industrial robot if the following signals have the following states:

Signal	State required for SPOC
\$USER_SAF	TRUE
\$SPOC_MOTION_ENABLE	TRUE

### Submit interpreter, PLC

If motions, (e.g. drives or grippers) are controlled with the submit interpreter or the PLC via the I/O system, and if they are not safeguarded by other means, then this control will take effect even in T1 and T2 modes or while an EMERGENCY STOP is active.

If variables that affect the robot motion (e.g. override) are modified with the submit interpreter or the PLC, this takes effect even in T1 and T2 modes or while an EMERGENCY STOP is active.

Safety measures:

- In T1 and T2, the system variable \$OV\_PRO must not be written to by the submit interpreter or the PLC.
- Do not modify safety-relevant signals and variables (e.g. operating mode, EMERGENCY STOP, safety gate contact) via the submit interpreter or PLC.

If modifications are nonetheless required, all safety-relevant signals and variables must be linked in such a way that they cannot be set to a dangerous state by the submit interpreter or PLC. This is the responsibility of the system integrator.

### OPC server, remote control tools

These components can be used with write access to modify programs, outputs or other parameters of the robot controller, without this being noticed by any persons located inside the system.

Safety measure:

If these components are used, outputs that could cause a hazard must be determined in a risk assessment. These outputs must be designed in such a way that they cannot be set without being enabled. This can be done using an external enabling device, for example.

### Tools for configuration of bus systems

If these components have an online functionality, they can be used with write access to modify programs, outputs or other parameters of the robot controller, without this being noticed by any persons located inside the system.

- WorkVisual from KUKA
- Tools from other manufacturers

Safety measure:

In the test modes, programs, outputs or other parameters of the robot controller must not be modified using these components.

## 5.9 Applied norms and regulations

Name	Definition	Edition
2006/42/EC	<b>Machinery Directive:</b> Directive 2006/42/EC of the European Parliament and of the Council of 17 May 2006 on machinery, and amending Directive 95/16/EC (recast)	2006



<b>2004/108/EC</b>	<b>EMC Directive:</b> Directive 2004/108/EC of the European Parliament and of the Council of 15 December 2004 on the approximation of the laws of the Member States relating to electromagnetic compatibility and repealing Directive 89/336/EEC	2004
<b>97/23/EC</b>	<b>Pressure Equipment Directive:</b> Directive 97/23/EC of the European Parliament and of the Council of 29 May 1997 on the approximation of the laws of the Member States concerning pressure equipment  (Only applicable for robots with hydropneumatic counterbalancing system.)	1997
<b>EN ISO 13850</b>	<b>Safety of machinery:</b> Emergency stop - Principles for design	2008
<b>EN ISO 13849-1</b>	<b>Safety of machinery:</b> Safety-related parts of control systems - Part 1: General principles of design	2008
<b>EN ISO 13849-2</b>	<b>Safety of machinery:</b> Safety-related parts of control systems - Part 2: Validation	2012
<b>EN ISO 12100</b>	<b>Safety of machinery:</b> General principles of design, risk assessment and risk reduction	2010
<b>EN ISO 10218-1</b>	<b>Industrial robots:</b> Safety  <b>Note:</b> Content equivalent to <b>ANSI/RIA R.15.06-2012, Part 1</b>	2011
<b>EN 614-1</b>	<b>Safety of machinery:</b> Ergonomic design principles - Part 1: Terms and general principles	2009
<b>EN 61000-6-2</b>	<b>Electromagnetic compatibility (EMC):</b> Part 6-2: Generic standards; Immunity for industrial environments	2005
<b>EN 61000-6-4</b>	<b>Electromagnetic compatibility (EMC):</b> Part 6-4: Generic standards; Emission standard for industrial environments	2007
<b>EN 60204-1 + A1</b>	<b>Safety of machinery:</b> Electrical equipment of machines - Part 1: General requirements	2009



## 6 Planning

### 6.1 Overview of planning

 This is an overview of the most important planning specifications. The precise planning depends on the application, the manipulator type, the technology packages used and other customer-specific circumstances. For this reason, the overview does not claim to be comprehensive.

#### Robot controller

Step	Description	Information
1	Electromagnetic compatibility (EMC)	(>>> 6.2 "Electromagnetic compatibility (EMC)" Page 51)
2	Installation conditions for robot controller	(>>> 6.3 "Installation conditions" Page 51)
3	Connection conditions	(>>> 6.4 "Connection conditions" Page 52)
4	Power supply connection	(>>> 6.5 "Power supply connection" Page 53)
5	Safety interface X11	(>>> 6.6 "Safety interface X11" Page 53)
6	Ethernet safety interface X66	(>>> 6.7 "Safety functions via Ethernet safety interface (optional)" Page 61)
7	Mastering test	(>>> 6.8 "Mastering test" Page 68)
8	KUKA Extension Bus interface X65	(>>> 6.9 "EtherCAT interface X65" Page 68)
9	KUKA System Bus interface X69	(>>> 6.10 "Service Interface X69" Page 69)
10	PE equipotential bonding	(>>> 6.11 "PE equipotential bonding" Page 70)
11	Performance Level	(>>> 6.12 "Performance level" Page 70)

### 6.2 Electromagnetic compatibility (EMC)

**Description** If connecting cables (e.g. field buses, etc.) are routed to the control PC from outside, only shielded cables with an adequate degree of shielding may be used.

 The robot controller corresponds to EMC class A, Group 1, in accordance with EN 55011 and is intended for use in an **industrial setting**. Ascertaining the electromagnetic compatibility in other environments can result in difficulties due to conducted and radiated disturbance that may occur.

### 6.3 Installation conditions

**Dimensions** The robot controller can be installed in a 19" rack or as a standalone device. The specifications in the "Technical data" chapter must be observed. If the robot controller is to be installed in a 19" rack, the depth must be at least

600 mm. The robot controller may only be installed and operated in the horizontal position.

**i** If the robot controller is to be installed in a 19" rack, it must be fastened in the rack by appropriate means (preferably angle plates) along the entire side edge in order to prevent distortion of the housing.

Both sides of the robot controller must be accessible to the cooling air. Clearance of 70 mm on each side.

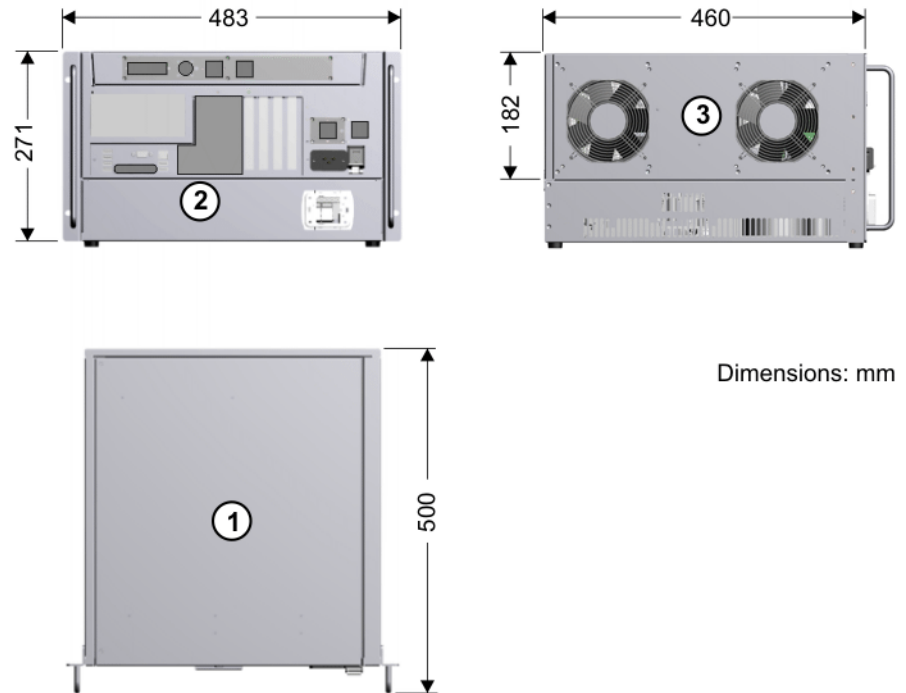

Fig. 6-1: Dimensions

**Handle brackets**

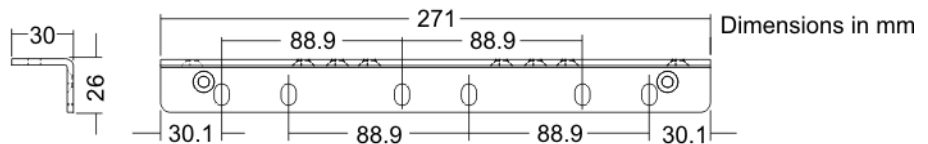

Fig. 6-2: Dimensions of handle brackets

**6.4 Connection conditions**

**Power supply connection**

The robot controller may only be connected to grounded-neutral power supply systems.

Rated supply voltage	200 V - 230 V AC, single-phase, two-phase (with grounded neutral (as symmetrical as possible) between the phases used)
Permissible tolerance of rated supply voltage	Rated supply voltage $\pm 10\%$
Mains frequency	50 Hz $\pm 1$ Hz or 60 Hz $\pm 1$ Hz
Rated power input	2 kVA, see rating plate
Thermal power dissipation	max. 400 W

Mains-side fusing	2x 16 A slow-blowing (1 (2)x phase; 1x neutral conductor (optional))
Equipotential bonding	The common neutral point for the equipotential bonding conductors and all protective ground conductors is the reference bus of the power unit

 **CAUTION** If the robot controller is connected to a power system **without** a grounded neutral, this may cause malfunctions in the robot controller and material damage to the power supply units. Electrical voltage can cause injuries. The robot controller may only be operated with grounded-neutral power supply systems.

 If use of a residual-current circuit-breaker (RCCB) is planned, we recommend the following RCCB: trip current difference 300 mA per robot controller, universal-current sensitive, selective.

### Cable lengths

For cable designations, standard lengths and optional lengths, please refer to the operating instructions or assembly instructions of the manipulator and/or the assembly and operating instructions for KR C4 external cabling for robot controllers.

 When using smartPAD cable extensions, only two extensions may be used. An overall cable length of 50 m must not be exceeded.

 The difference in the cable lengths between the individual channels of the RDC box must not exceed 10 m.

## 6.5 Power supply connection

<b>Description</b>	The robot controller is connected to the mains via a 3-pole socket for non-heating apparatus connector.
<b>Infeed</b>	<ul style="list-style-type: none"> <li>■ 200 V - 230 V AC, single-phase, two-phase (with grounded neutral (as symmetrical as possible) between the phases used</li> <li>■ 50 Hz <math>\pm</math> 1 Hz or 60 Hz <math>\pm</math> 1 Hz</li> </ul>
<b>Fusing</b>	<ul style="list-style-type: none"> <li>■ 2x 16 A slow-blowing, type C (1 (2)x phase; 1x neutral conductor (optional))</li> </ul>

## 6.6 Safety interface X11

<b>Description</b>	EMERGENCY STOP devices must be connected via safety interface X11 or linked together by means of higher-level controllers (e.g. PLC).
<b>Wiring</b>	<p>Take the following points into consideration when wiring safety interface X11:</p> <ul style="list-style-type: none"> <li>■ System concept</li> <li>■ Safety concept</li> </ul>

6.6.1 Safety interface X11

Connector pin allocation

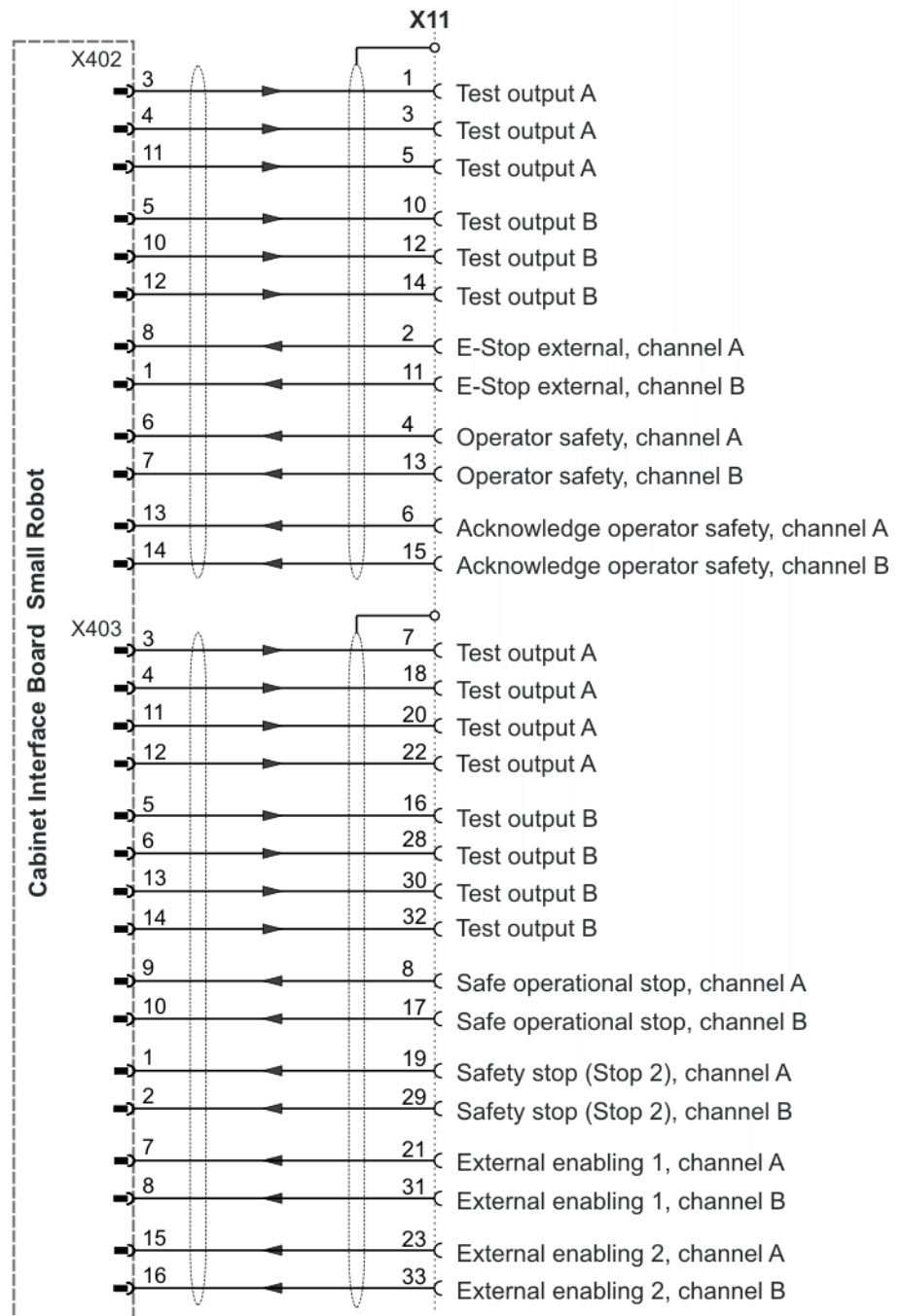

Fig. 6-3: Interface X11, part 1

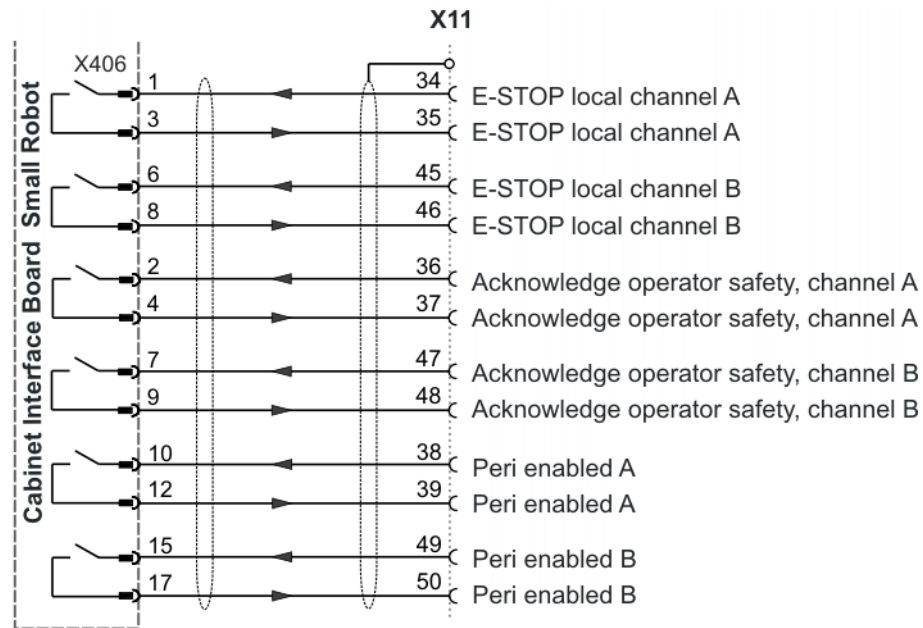

Fig. 6-4: Interface X11, part 2

Signal	Pin	Description	Comments
Test output A (test signal)	1/3/5	Makes the pulsed voltage available for the individual interface inputs of channel A.	-
	7/18		
	20/22		
Test output B (test signal)	10/12/14	Makes the pulsed voltage available for the individual interface inputs of channel B.	-
	16/28		
	30/32		
External E-STOP, channel A	2	E-STOP, dual-channel input, max. 24 V. (>>> "CIB_SR inputs" Page 24)	Triggering of the E-STOP function in the robot controller.
External E-STOP, channel B	11		
Operator safety, channel A	4	For dual-channel connection of a safety gate locking mechanism, max. 24 V. (>>> "CIB_SR inputs" Page 24)	As long as the signal is active, the drives can be switched on. Only effective in the AUTOMATIC modes.
Operator safety, channel B	13		
Acknowledge operator safety, channel A	6	For connection of a dual-channel input for acknowledging operator safety with floating contacts. (>>> "CIB_SR inputs" Page 24)	The response of the "Operator safety acknowledgement" input can be configured in the KUKA system software.
Acknowledge operator safety, channel B	15		

Signal	Pin	Description	Comments
Safe operational stop, channel A	8	Safe operational stop input for all axes	Activation of standstill monitoring  Stop 0 is initiated if the activated monitoring is violated.
Safe operational stop, channel B	17		
Safety stop, Stop 2 channel A	19	Safety stop (Stop 2) input for all axes	Triggering of Stop 2 and activation of standstill monitoring at standstill of all axes.  Stop 0 is initiated if the activated monitoring is violated.
Safety stop, Stop 2 channel B	29		
External enabling 1 channel A	21	For connection of an external 2-channel enabling switch 1 with floating contacts.	If no external enabling switch 1 is connected, channel A pins 20/21 and channel B 30/31 must be jumpered. Only effective in TEST modes.
External enabling 1 channel B	31		
External enabling 2 channel A	23	For connection of an external 2-channel enabling switch 2 with floating contacts.	If no external enabling switch 2 is connected, channel A pins 22/23 and channel B 32/33 must be jumpered. Only effective in TEST modes.
External enabling 2 channel B	33		
E-STOP local channel A	34 35	Output, floating contacts from internal E-STOP. (>>> "CIB_SR outputs" Page 23)	The contacts are closed if the following conditions are met:  <ul style="list-style-type: none"> <li>■ E-STOP on smartPAD not actuated</li> <li>■ Controller switched on and operational</li> </ul> The contacts open if any condition is not met.
E-STOP local channel B	45 46		
Acknowledge operator safety, channel A	36	Output, floating contact for operator safety acknowledgement, connection 1	Relaying of the acknowledge operator safety input signal to other robot controllers at the same safety fencing.
	37	Output, floating contact for operator safety acknowledgement, connection 2	
Acknowledge operator safety, channel B	47	Output, floating contact for operator safety acknowledgement, connection 1	
	48	Output, floating contact for operator safety acknowledgement, connection 2	
Peri enabled channel A	38	Output, floating contact	(>>> "Signal "Peri enabled"" Page 57)
	39	Output, floating contact	
Peri enabled channel B	49	Output, floating contact	
	50	Output, floating contact	

**Function of external axis enabling switch**

- External enabling 1  
Enabling switch must be pressed for jogging in T1 or T2. Input is closed.
- External enabling 2  
Enabling switch is not in the panic position. Input is closed.



- If a smartPAD is connected, its enabling switches and the external enabling are ANDed.

Function (only active for T1 and T2)	External enabling 1	External enabling 2	Switch position
Safety stop 1 (drives switched off when axis at standstill)	Input open	Input open	No operational state
Safety stop 2 (safe operational stop, drives switched on)	Input open	Input closed	Not pressed
Safety stop 1 (drives switched off when axis at standstill)	Input closed	Input open	Panic position
Axes enabled (axis jogging possible)	Input closed	Input closed	Center position

### Signal “Peri enabled”

The signal “Peri enabled” is set to 1 (active) if the following conditions are met:

- Drives are switched on.
- Safety controller motion enable signal present.
- The message “Operator safety open” must not be active.  
This message is only active in the modes T1 and T2.

#### “Peri enabled” in conjunction with the signal “Safe operational stop”

- In the case of activation of the signal “Safe operational stop” during the motion:
  - Error -> braking with Stop 0. “Peri enabled” eliminated.
- Activation of the signal “Safe operational stop” with the manipulator stationary:
  - Release the brakes, switch drives to servo-control and monitor for restart. “Peri enabled” remains active.
    - Signal “Motion enable” remains active.
    - Signal “Peri enabled” remains active.

#### “Peri enabled” in conjunction with the signal “Safety stop 2”

- In the case of activation of the signal “Safety stop 2”:
  - Stop 2 of the manipulator.
  - Signal “Drive enable” remains active.
  - Brakes remain released.
  - Manipulator remains under servo-control.
  - Monitoring for restart active.
  - Signal “Motion enable” is deactivated.
  - Signal “Peri enabled” is deactivated.

## 6.6.2 Wiring example for E-STOP circuit and safeguard

### Description

The EMERGENCY STOP devices are connected to X11 in the robot controller.

### EMERGENCY STOP

 **WARNING** The EMERGENCY STOP devices on the robot controller must be integrated into the EMERGENCY STOP circuit of the system by the system integrator. Failure to do this may result in death, severe injuries or considerable damage to property.

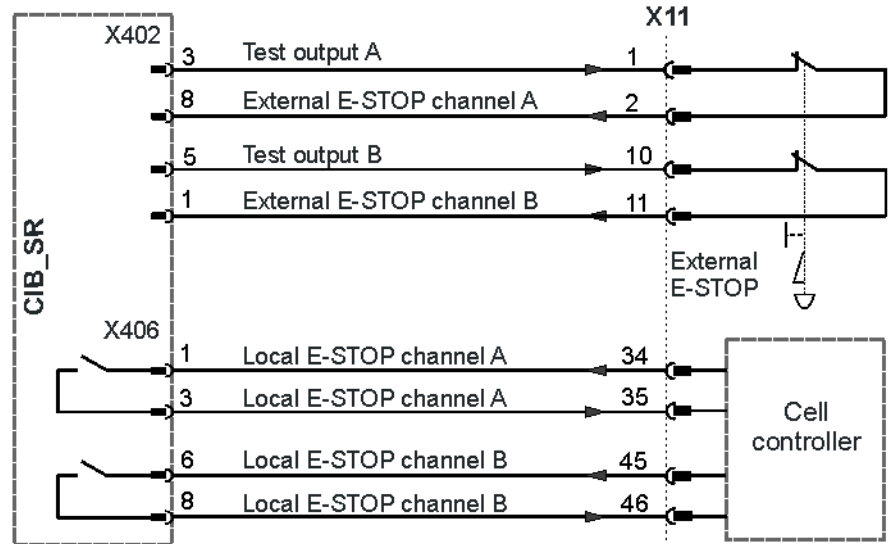

Fig. 6-5: Wiring example: EMERGENCY STOP

**Safety gate**

A dual-channel acknowledge button must be installed outside the physical safeguard. The system integrator must ensure that closing the safety gate inadvertently does not directly set the signal for operator safety. After the safety gate has closed, the signal for operator safety must only be confirmed by an external device, e.g. an acknowledge button, that can only be accessed from outside the danger zone. The closing of the safety gate must be confirmed by pressing the acknowledge button before the industrial robot can be started again in Automatic mode.

**⚠ WARNING** The safety gate on the robot controller must be integrated into the safeguard circuit of the system by the system integrator. Failure to do this may result in death, severe injuries or considerable damage to property.

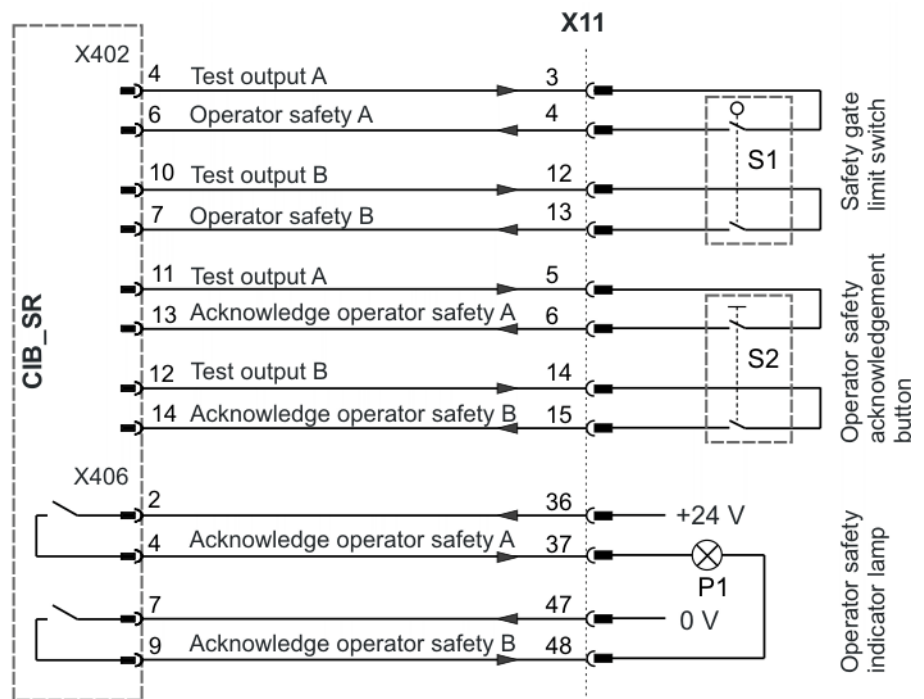

Fig. 6-6: Wiring example: Operator safety with safety gate

### 6.6.3 Wiring example for safe inputs and outputs

#### Safe input

The switch-off capability of the inputs is monitored cyclically.

The inputs of the CIB\_SR are of dual-channel design with external testing. The dual-channel operation of the inputs is monitored cyclically.

The following diagram illustrates the connection of a safe input to a floating contact provided by the customer.

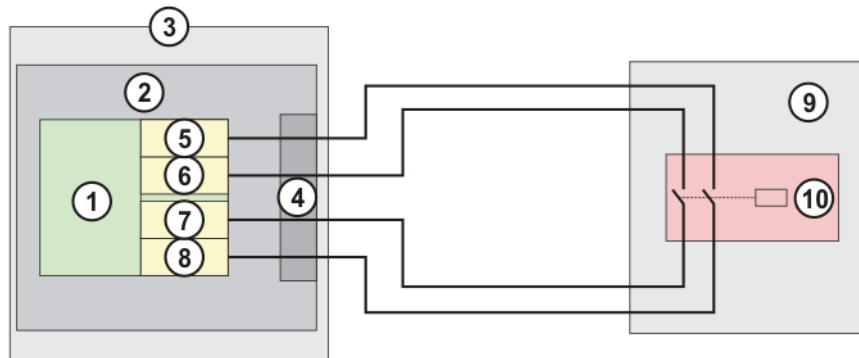

**Fig. 6-7: Connection schematic for safe input**

- 1 Failsafe input CIB\_SR
- 2 CIB\_SR
- 3 Robot controller
- 4 Interface X11
- 5 Test output channel B
- 6 Test output channel A
- 7 Input X, channel A
- 8 Input X, channel B
- 9 System side
- 10 Floating contact

Test outputs A and B are fed with the supply voltage of the CIB\_SR. Test outputs A and B are sustained short-circuit proof. The test outputs must only be used to supply the CIB\_SR inputs, and for no other purpose.

The wiring example can be used to achieve compliance with SIL2 (DIN EN 62061) and Cat. 3 (DIN EN 13849).

#### Dynamic testing

- The switch-off capability of the inputs is tested cyclically. For this, the test outputs TA\_A and TA\_B are switched off alternately.
- The switch-off pulse length is defined for the CIB\_SRs as  $t_1 = 625 \mu\text{s}$  (125  $\mu\text{s}$  – 2.375 ms).
- The duration  $t_2$  between two switch-off pulses on one channel is 106 ms.
- The input channel SIN\_x\_A must be supplied by the test signal TA\_A. The input channel SIN\_x\_B must be supplied by the test signal TA\_B. No other power supply is permissible.
- It is only permitted to connect sensors which allow the connection of test signals and which provide floating contacts.
- The signals TA\_A and TA\_B must not be significantly delayed by the switching element.

**Switch-off pulse diagram**

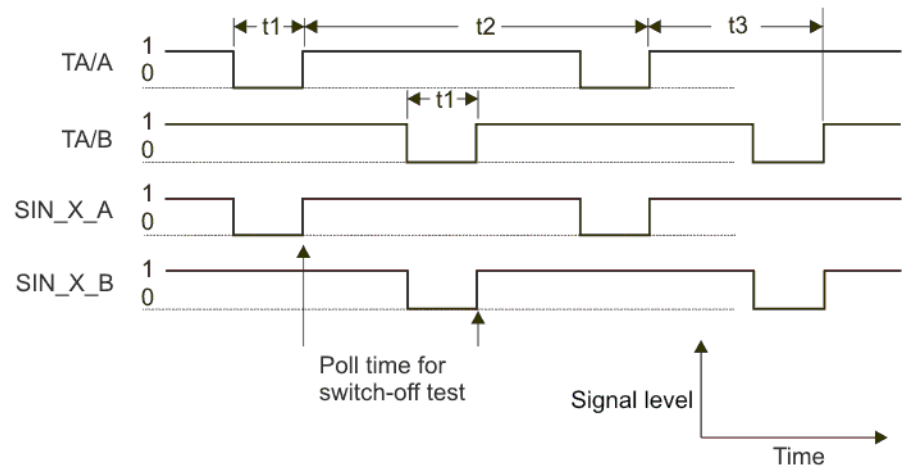

**Fig. 6-8: Switch-off pulse diagram, test outputs**

- t1 Switch-off pulse length (fixed or configurable)
- t2 Switch-off period per channel (106 ms)
- t3 Offset between switch-off pulses of both channels (53 ms)
- TA/A Test output channel A
- TA/B Test output channel B
- SIN\_X\_A Input X, channel A
- SIN\_X\_B Input X, channel B

**Safe output**

On the CIB\_SR, the outputs are provided as dual-channel floating relay outputs.

The following diagram illustrates the connection of a safe output to a safe input provided by the customer with external test facility. The input used by the customer must be monitored externally for cross-connection.

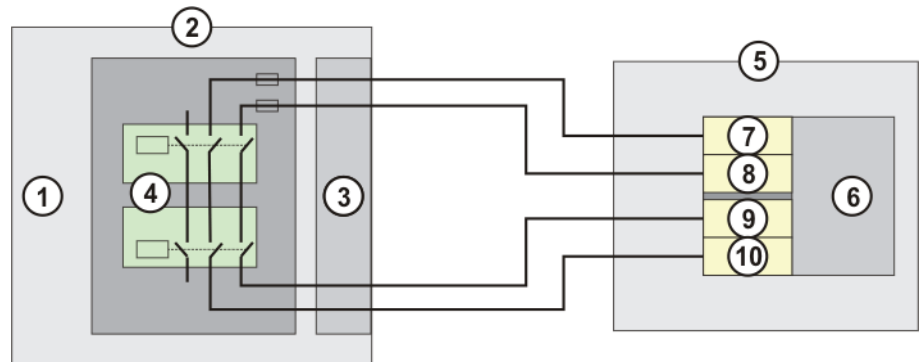

**Fig. 6-9: Connection schematic for safe output**

- 1 CIB\_SR
- 2 Robot controller
- 3 Interface X11, safe output
- 4 Output wiring
- 5 System side
- 6 Safe input (Fail Safe PLC, safety switching device)
- 7 Test output channel B
- 8 Test output channel A
- 9 Input X, channel A
- 10 Input X, channel B

The wiring example shown can be used to achieve compliance with SIL2 (DIN EN 62061) and Cat. 3 (DIN EN 13849).

## 6.7 Safety functions via Ethernet safety interface (optional)

**Description** The exchange of safety-relevant signals between the controller and the system is carried out via the Ethernet safety interface (e.g. PROFIsafe or CIP Safety). The assignment of the input and output states within the Ethernet safety interface protocol are listed below. In addition, non-safety-oriented information from the safety controller is sent to the non-safe section of the higher-level controller for the purpose of diagnosis and control.

**Reserved bits** Reserved safe inputs can be pre-assigned by a PLC with the values **0** or **1**. In both cases, the manipulator will move. If a safety function is assigned to a reserved input (e.g. in the case of a software update) and if this input is preset with the value **0**, then the manipulator would either not move or would unexpectedly come to a standstill.



KUKA recommends pre-assignment of the reserved inputs with **1**. If a reserved input has a new safety function assigned to it, and the input is not used by the customer's PLC, the safety function is not activated. This prevents the safety controller from unexpectedly stopping the manipulator.

### Input byte 0

Bit	Signal	Description
0	RES	Reserved 1 The value <b>1</b> must be assigned to the input.
1	NHE	Input for external Emergency Stop <b>0</b> = external E-STOP is active <b>1</b> = external E-STOP is not active
2	BS	Operator safety <b>0</b> = operator safety is not active, e.g. safety gate open <b>1</b> = operator safety is active
3	QBS	Acknowledgement of operator safety Precondition for acknowledgement of operator safety is the signal "Operator safety assured" set in the BS bit. <b>Note:</b> If the "BS" signal is acknowledged by the system, this must be specified under <b>Hardware options</b> in the safety configuration. Information is contained in the Operating and Programming Instructions for System Integrators. <b>0</b> = operator safety has not been acknowledged Edge <b>0</b> -> <b>1</b> = operator safety has been acknowledged

Bit	Signal	Description
4	SHS1	<p>Safety STOP 1 (all axes)</p> <ul style="list-style-type: none"> <li>■ FF (motion enable) is set to <b>0</b>.</li> <li>■ Voltage US2 is switched off.</li> <li>■ AF (drives enable) is set to <b>0</b> after 1.5 s.</li> </ul> <p>Cancellation of this function does not require acknowledgement.</p> <p>This function is not permissible for the EMERGENCY STOP function.</p> <p><b>0</b> = safety stop is active <b>1</b> = safety stop is not active</p>
5	SHS2	<p>Safety STOP 2 (all axes)</p> <ul style="list-style-type: none"> <li>■ FF (motion enable) is set to <b>0</b>.</li> <li>■ Voltage US2 is switched off.</li> </ul> <p>Cancellation of this function does not require acknowledgement.</p> <p>This function is not permissible for the EMERGENCY STOP function.</p> <p><b>0</b> = safety stop is active <b>1</b> = safety stop is not active</p>
6	RES	-
7	RES	-

#### Input byte 1

Bit	Signal	Description
0	US2	<p>Supply voltage US2 (signal for switching the second supply voltage, US2, without battery backup)</p> <p>If this output is not used, it should be set to 0.</p> <p><b>0</b> = switch off US2 <b>1</b> = switch on US2</p> <p><b>Note:</b> Whether and how input US2 is used must be specified under <b>Hardware options</b> in the safety configuration. Information is contained in the Operating and Programming Instructions for System Integrators.</p>
1	SBH	<p>Safe operational stop (all axes)</p> <p>Precondition: All axes are stationary</p> <p>Cancellation of this function does not require acknowledgement.</p> <p>This function is not permissible for the EMERGENCY STOP function.</p> <p><b>0</b> = safe operational stop is active. <b>1</b> = safe operational stop is not active.</p>
2	RES	<p>Reserved 11</p> <p>The value <b>1</b> must be assigned to the input.</p>
3	RES	<p>Reserved 12</p> <p>The value <b>1</b> must be assigned to the input.</p>

Bit	Signal	Description
4	RES	Reserved 13 The value 1 must be assigned to the input.
5	RES	Reserved 14 The value 1 must be assigned to the input.
6	RES	Reserved 15 The value 1 must be assigned to the input.
7	SPA	System Powerdown Acknowledge The system confirms that it has received the power-down signal. A second after the "SP" (System Power-down) signal has been set by the controller, the requested action is executed, without the need for confirmation from the PLC, and the controller shuts down.  <b>0</b> = confirmation is not active <b>1</b> = confirmation is active

**Output byte 0**

Bit	Signal	Description
0	NHL	Local E-STOP (local E-STOP triggered) <b>0</b> = local E-STOP is active <b>1</b> = local E-STOP is not active
1	AF	Drives enable (the internal safety controller in the KRC has enabled the drives so that they can be switched on) <b>0</b> = drives enable is not active (the robot controller must switch the drives off) <b>1</b> = drives enable is active (the robot controller must switch the drives to servo-control)
2	FF	Motion enable (the internal safety controller in the KRC has enabled robot motions) <b>0</b> = motion enable is not active (the robot controller must stop the current motion) <b>1</b> = motion enable is active (the robot controller may trigger a motion)
3	ZS	One of the enabling switches is in the center position (enabling in test mode) <b>0</b> = enabling is not active <b>1</b> = enabling is active
4	PE	The signal "Peri enabled" is set to 1 (active) if the following conditions are met: <ul style="list-style-type: none"> <li>■ Drives are switched on.</li> <li>■ Safety controller motion enable signal present.</li> <li>■ The message "Operator safety open" must not be active.</li> </ul>
5	AUT	The manipulator is in AUT or AUT EXT mode. <b>0</b> = AUT or AUT EXT mode is not active <b>1</b> = AUT or AUT EXT mode is active

Bit	Signal	Description
6	T1	The manipulator is in Manual Reduced Velocity mode. <b>0</b> = T1 mode is not active <b>1</b> = T1 mode is active
7	T2	The manipulator is in Manual High Velocity mode. <b>0</b> = T2 mode is not active <b>1</b> = T2 mode is active

**Output byte 1**

Bit	Signal	Description
0	NHE	External E-STOP has been triggered. <b>0</b> = external E-STOP is active <b>1</b> = external E-STOP is not active
1	BS	Operator safety <b>0</b> = operator safety is not assured <b>1</b> = operator safety is assured (input BS = 1 and, if configured, input QBS acknowledged)
2	SHS1	Safety stop 1 (all axes) <b>0</b> = Safety stop 1 is not active <b>1</b> = Safety stop 1 is active (safe state reached)
3	SHS2	Safety stop 2 (all axes) <b>0</b> = Safety stop 2 is not active <b>1</b> = Safety stop 2 is active (safe state reached)
4	RES	Reserved 13
5	RES	Reserved 14
6	PSA	Safety interface active Precondition: An Ethernet interface must be installed on the controller, e.g. PROFINET or Ethernet/IP <b>0</b> = safety interface is not active <b>1</b> = safety interface is active
7	SP	System Powerdown (controller will be shut down) One second after the SP signal has been set, the PSA output is reset by the robot controller, without confirmation from the PLC, and the controller is shut down. <b>0</b> = controller on safety interface is active. <b>1</b> = controller will be shut down

**6.7.1 Schematic circuit diagram for enabling switches****Description**

An external enabling switch can be connected to the higher-level safety controller. The signals (ZSE make contact and External panic break contact) must be correctly linked to the Ethernet safety interface signals in the safety controller. The resulting Ethernet safety interface signals must then be routed to the PROFIsafe of the KR C4. The response to the external enabling switch is then identical to that for a discretely connected X11.



## Signals

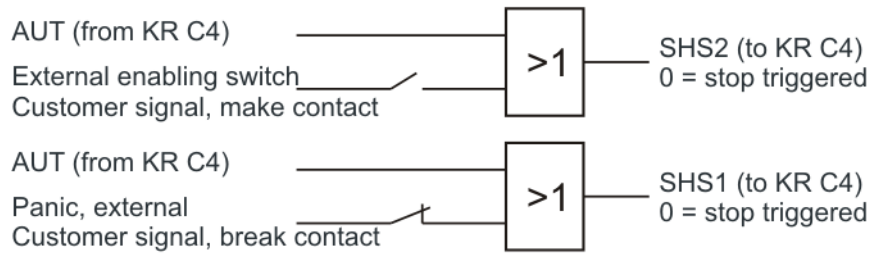

**Fig. 6-10: Schematic circuit diagram of external enabling switch**

- Enabling switch center position (make contact closed (1) = enabled) OR AUT at SHS2
- Panic (break contact open (0) = panic position) = AND not AUT at SHS1

### 6.7.2 SafeOperation via Ethernet safety interface (optional)

#### Description

The components of the industrial robot move within the limits that have been configured and activated. The actual positions are continuously calculated and monitored against the safety parameters that have been set. The safety controller monitors the industrial robot by means of the safety parameters that have been set. If a component of the industrial robot violates a monitoring limit or a safety parameter, the manipulator and external axes (optional) are stopped. The Ethernet safety interface can be used, for example, to signal a violation of safety monitoring functions.

In the case of the KR C4 compact robot controller, safety options such as SafeOperation are only available via the Ethernet safety interface from KSS/VSS 8.3 onwards.

#### Reserved bits

Reserved safe inputs can be pre-assigned by a PLC with the values **0** or **1**. In both cases, the manipulator will move. If a safety function is assigned to a reserved input (e.g. in the case of a software update) and if this input is preset with the value **0**, then the manipulator would either not move or would unexpectedly come to a standstill.



KUKA recommends pre-assignment of the reserved inputs with **1**. If a reserved input has a new safety function assigned to it, and the input is not used by the customer's PLC, the safety function is not activated. This prevents the safety controller from unexpectedly stopping the manipulator.

#### Input byte 2

Bit	Signal	Description
0	JR	Mastering test (input for the reference switch of the mastering test)  <b>0</b> = reference switch is active (actuated).  <b>1</b> = reference switch is not active (not actuated).

Bit	Signal	Description
1	VRED	Reduced axis-specific and Cartesian velocity (activation of reduced velocity monitoring) <b>0</b> = reduced velocity monitoring is active. <b>1</b> = reduced velocity monitoring is not active.
2 ... 7	SBH1 ... 6	Safe operational stop for axis group 1 ... 6 Assignment: Bit 2 = axis group 1 ... bit 7 = axis group 6 Signal for safe operational stop. The function does not trigger a stop, it only activates the safe standstill monitoring. Cancellation of this function does not require acknowledgement. <b>0</b> = safe operational stop is active. <b>1</b> = safe operational stop is not active.

**Input byte 3**

Bit	Signal	Description
0 ... 7	RES	Reserved 25 ... 32 The value <b>1</b> must be assigned to the inputs.

**Input byte 4**

Bit	Signal	Description
0 ... 7	UER1 ... 8	Monitoring spaces 1 ... 8 Assignment: Bit 0 = monitoring space 1 ... bit 7 = monitoring space 8 <b>0</b> = monitoring space is active. <b>1</b> = monitoring space is not active.

**Input byte 5**

Bit	Signal	Description
0 ... 7	UER9 ... 16	Monitoring spaces 9 ... 16 Assignment: Bit 0 = monitoring space 9 ... bit 7 = monitoring space 16 <b>0</b> = monitoring space is active. <b>1</b> = monitoring space is not active.

**Input byte 6**

Bit	Signal	Description
0 ... 7	WZ1 ... 8	Tool selection 1 ... 8 Assignment: Bit 0 = tool 1 ... bit 7 = tool 8 <b>0</b> = tool is not active. <b>1</b> = tool is active. Exactly one tool must be selected at all times.

**Input byte 7**

Bit	Signal	Description
0 ... 7	WZ9 ... 16	Tool selection 9 ... 16 Assignment: Bit 0 = tool 9 ... bit 7 = tool 16 <b>0</b> = tool is not active. <b>1</b> = tool is active. Exactly one tool must be selected at all times.

## Output byte 2

Bit	Signal	Description
0	SO	Safety option active SafeOperation activation status <b>0</b> = safety option is not active <b>1</b> = safety option is active
1	RR	Manipulator referenced Mastering test display <b>0</b> = mastering test required. <b>1</b> = mastering test performed successfully.
2	JF	Mastering error Space monitoring is deactivated because at least one axis is not mastered. <b>0</b> = mastering error. Space monitoring has been deactivated. <b>1</b> = no error.
3	VRED	Reduced axis-specific and Cartesian velocity (activation status of reduced velocity monitoring) <b>0</b> = reduced velocity monitoring is not active. <b>1</b> = reduced velocity monitoring is active.
4 ... 7	SBH1 ... 4	Activation status of safe operational stop for axis group 1 ... 4 Assignment: Bit 4 = axis group 1 ... bit 7 = axis group 4 <b>0</b> = safe operational stop is not active. <b>1</b> = safe operational stop is active.

## Output byte 3

Bit	Signal	Description
0 ... 1	SBH5 ... 6	Activation status of safe operational stop for axis group 5 ... 6 Assignment: Bit 0 = axis group 5 ... bit 1 = axis group 6 <b>0</b> = safe operational stop is not active. <b>1</b> = safe operational stop is active.
2 ... 7	RES	Reserved 27 ... 32

## Output byte 4

Bit	Signal	Description
0 ... 7	MR1 ... 8	Alarm space 1 ... 8 Assignment: Bit 0 = alarm space 1 (associated monitoring space 1) ... bit 7 = alarm space 8 (associated monitoring space 8) <b>0</b> = monitoring space is violated. <b>1</b> = monitoring space is not violated. <b>Note:</b> An inactive monitoring space is considered to be violated by default, i.e. in this case the associated safe output MRx has the state "0".

**Output byte 5**

Bit	Signal	Description
0 ... 7	MR9 ... 16	Alarm space 9 ... 16  Assignment: Bit 0 = alarm space 9 (associated monitoring space 9) ... bit 7 = alarm space 16 (associated monitoring space 16)  0 = monitoring space is violated. 1 = monitoring space is not violated.  <b>Note:</b> An inactive monitoring space is considered to be violated by default, i.e. in this case the associated safe output MRx has the state "0".

**Output byte 6**

Bit	Signal	Description
0 ... 7	RES	Reserved 49 ... 56

**Output byte 7**

Bit	Signal	Description
0 ... 7	RES	Reserved 57 ... 64

**6.7.3 Ethernet interface (1xRJ45) X66**

**Description**

Connector X66 on the connection panel is intended for connecting an external computer for the purpose of installation, programming, debugging and diagnosis.

**Connector pin allocation**



**Fig. 6-11: Connector pin allocation X66**

**Recommended cable**

Ethernet-compatible, min. category CAT 6.

**6.8 Mastering test**

For the mastering test, a reference switch must be connected to the safety PLC and activated via PROFIsafe or CIP Safety. The safety PLC must evaluate the reference switch and set the input "Mastering test" accordingly.

**6.9 EtherCAT interface X65**

**Description**

Connector X65 in the connection panel is the interface for connection of EtherCAT slaves outside the robot controller. The EtherCAT line is routed out of the robot controller.

 The EtherCAT devices must be configured with WorkVisual.

### Connector pin allocation

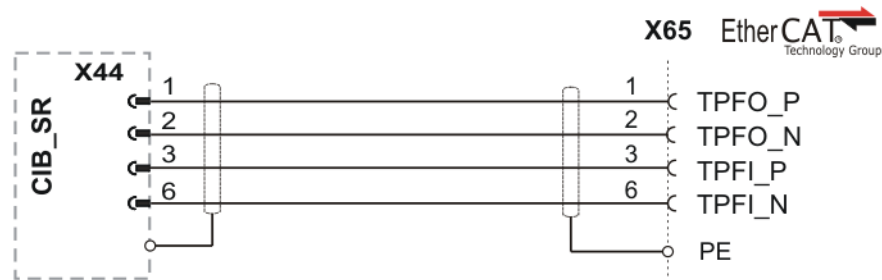

Fig. 6-12: Connector pin allocation X65 via CIB\_SR

### Connector pin allocation

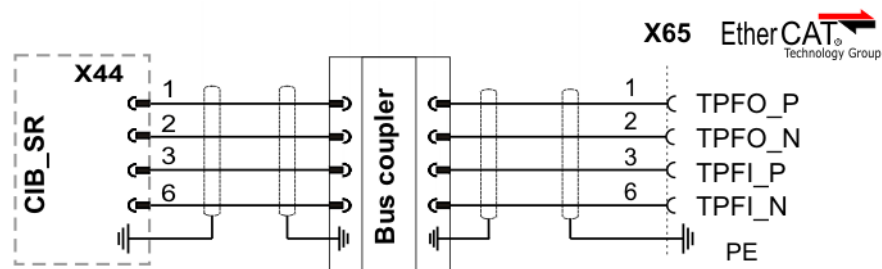

Fig. 6-13: Connector pin allocation X65 via bus coupler

**Recommended cable** Ethernet-compatible, min. category CAT 5.

## 6.10 Service Interface X69

**Description** Connector X69 on the connection panel is intended for connecting a notebook for the purpose of diagnosis, WorkVisual configuration, update, etc.

### Connector pin allocation

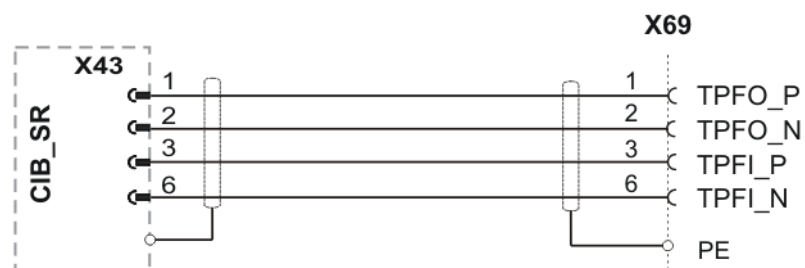
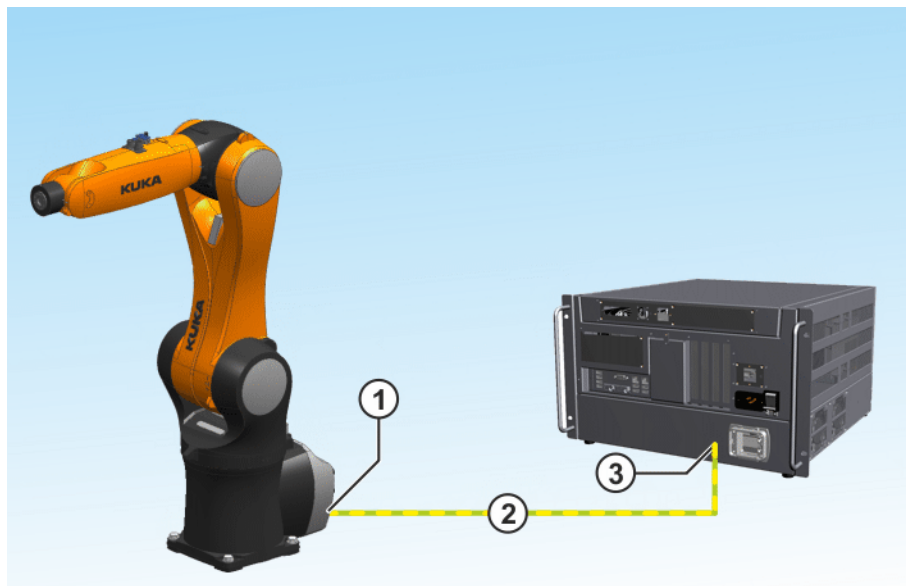

Fig. 6-14: Connector pin allocation X69 via CIB\_SR

**Recommended cable** Ethernet-compatible, min. category CAT 5.

## 6.11 PE equipotential bonding

### Description



**Fig. 6-15: Equipotential bonding between the manipulator and the robot controller**

A cable with a cross-section of at least 4 mm<sup>2</sup> must be used as equipotential bonding between the manipulator and the robot controller.

- |  |   |
|--|---|
| <p>1 Equipotential bonding connection on the manipulator</p> <p>2 Equipotential bonding, min. 4 mm<sup>2</sup></p> | <p>3 Equipotential bonding connection on the robot controller</p> |
|--|---|

## 6.12 Performance level

The safety functions of the robot controller conform to category 3 and Performance Level d according to EN ISO 13849-1.

### 6.12.1 PFH values of the safety functions

The safety values are based on a service life of 20 years.

The PFH value classification of the controller is only valid if the E-STOP device is tested at least once every 6 months.

When evaluating system safety functions, it must be remembered that the PFH values for a combination of multiple controllers may have to be taken into consideration more than once. This is the case for RoboTeam systems or higher-level hazard areas. The PFH value determined for the safety function at system level must not exceed the limit for PL d.

The PFH values relate to the specific safety functions of the different controller variants.

Safety function groups:

- Standard safety functions
  - Operating mode selection
  - Operator safety
  - EMERGENCY STOP device
  - Enabling device

- External safe operational stop
- External safety stop 1
- External safety stop 2
- Velocity monitoring in T1
- Safety functions of KUKA.SafeOperation (option)
  - Monitoring of axis spaces
  - Monitoring of Cartesian spaces
  - Monitoring of axis velocity
  - Monitoring of Cartesian velocity
  - Monitoring of axis acceleration
  - Safe operational stop
  - Tool monitoring

Overview of controller variant PFH values:

Robot controller variant	PFH value
KR C4 compact	$< 6.37 \times 10^{-8}$



For controller variants that are not listed here, please contact KUKA Roboter GmbH.





## 7 Transportation

### 7.1 Transporting the robot controller

- Preconditions**
- The housing of the robot controller must be closed.
  - No cables may be connected to the robot controller.
  - The robot controller must be transported in a horizontal position.
- Procedure**
- Transport the robot controller using a pallet truck or a fork lift truck. The robot controller must be laid on a pallet.

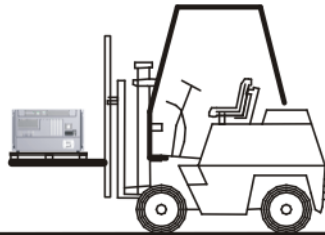

**Fig. 7-1: Transportation by fork lift truck**

**i** If the robot controller is installed in an electrical enclosure during transportation, this may result in vibrations (oscillations). Such vibrations can cause contact problems on the PC plug-in cards.



## 8 Start-up and recommissioning

### 8.1 Start-up overview

**i** This is an overview of the most important steps during start-up. The precise sequence depends on the application, the manipulator type, the technology packages used and other customer-specific circumstances. For this reason, the overview does not claim to be comprehensive.

**i** This overview refers to the start-up of the industrial robot. The start-up of the overall system is not within the scope of this documentation.

#### Manipulator

Step	Description	Information
1	Carry out a visual inspection of the manipulator.	Detailed information is contained in the operating or assembly instructions for the manipulator, in the chapter "Start-up and recommissioning".
2	Install the manipulator mounting base (mounting base, machine frame mounting or booster frame).	
3	Install the manipulator.	

#### Electrical system

Step	Description	Information
4	Carry out a visual inspection of the robot controller.	-
5	Make sure that no condensation has formed in the robot controller.	-
6	Install the robot controller.	(>>> 8.2 "Installing the robot controller" Page 76)
7	Connect the connecting cables.	(>>> 8.3 "Connecting the connecting cables" Page 76)
8	Plug in the KUKA smartPAD.	(>>> 8.4 "Plugging in the KUKA smartPAD" Page 77)
9	Connect the equipotential bonding between the manipulator and the robot controller.	(>>> 8.5 "Connecting the PE equipotential bonding" Page 78)
10	Connect the robot controller to the power supply.	(>>> 8.6 "Connecting the robot controller to the power supply" Page 78)
11	Reverse the battery discharge protection measures.	(>>> 8.7 "Reversing the battery discharge protection measures" Page 78)
12	Configure and connect safety interface X11.	(>>> 8.8 "Configuring and connecting connector X11" Page 79)
13	Switch on the robot controller.	(>>> 8.9 "Switching on the robot controller" Page 79)
14	Check the safety equipment.	Detailed information is contained in the operating and assembly instructions for the robot controller, in the "Safety" chapter.
15	Configure the inputs/outputs between the robot controller and the periphery.	Detailed information can be found in the field bus documentation.

## 8.2 Installing the robot controller

- Description** The robot controller can be installed in a 19" rack or as a standalone device.
- Preconditions**
- If the robot controller is to be installed in a 19" rack, the depth must be at least 600 mm.
  - Both sides of the robot controller must be accessible to the cooling air.
- Procedure**
1. Check the robot controller for any damage caused during transportation.
  2. Only install the robot controller horizontally.

## 8.3 Connecting the connecting cables

- Overview** A cable set is supplied with the robot system. The basic version consists of:
- Motor/data cable
  - Power supply connection cable
- The following cables may be provided for additional applications:
- Peripheral cables
- Procedure**
1. Connect motor connector X20 to the drive box.
  2. Connect data cable connector X21 to the control box.

### Connector pin allocation X20

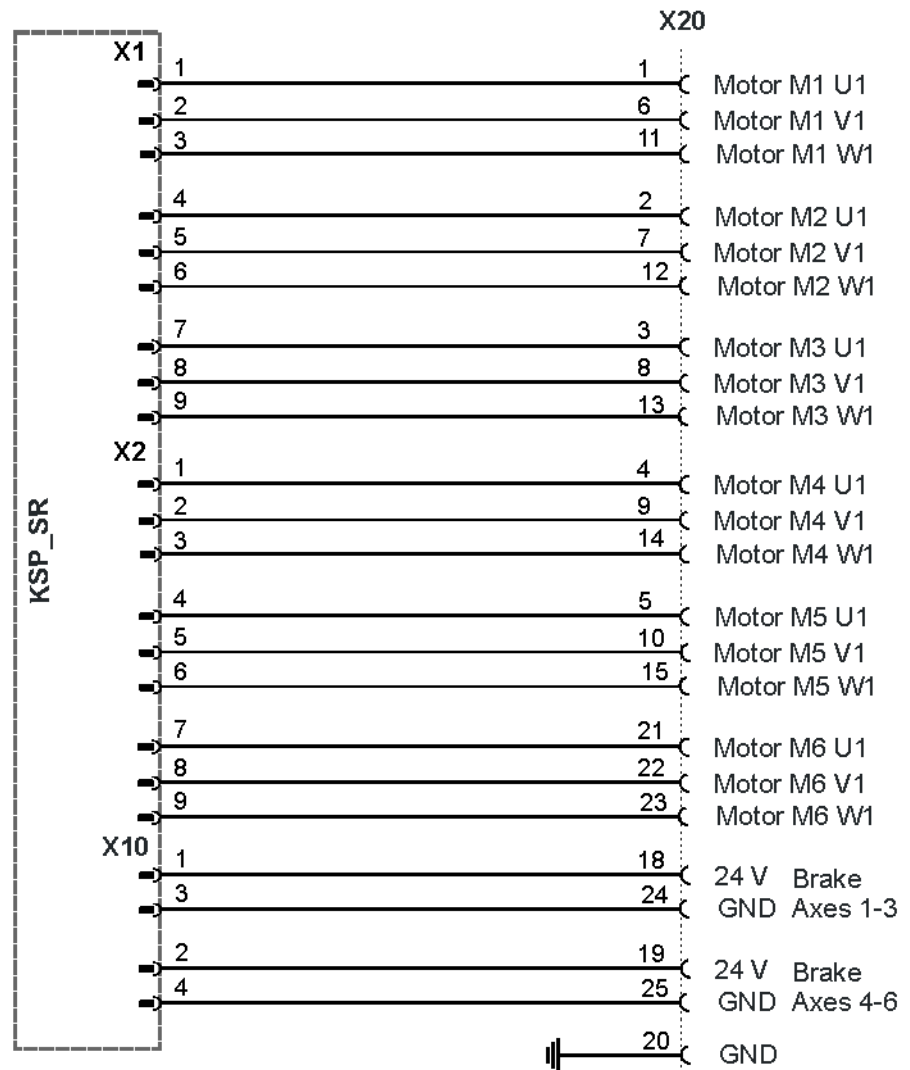

Fig. 8-1: Connector pin allocation for X20

### Connector pin allocation X21

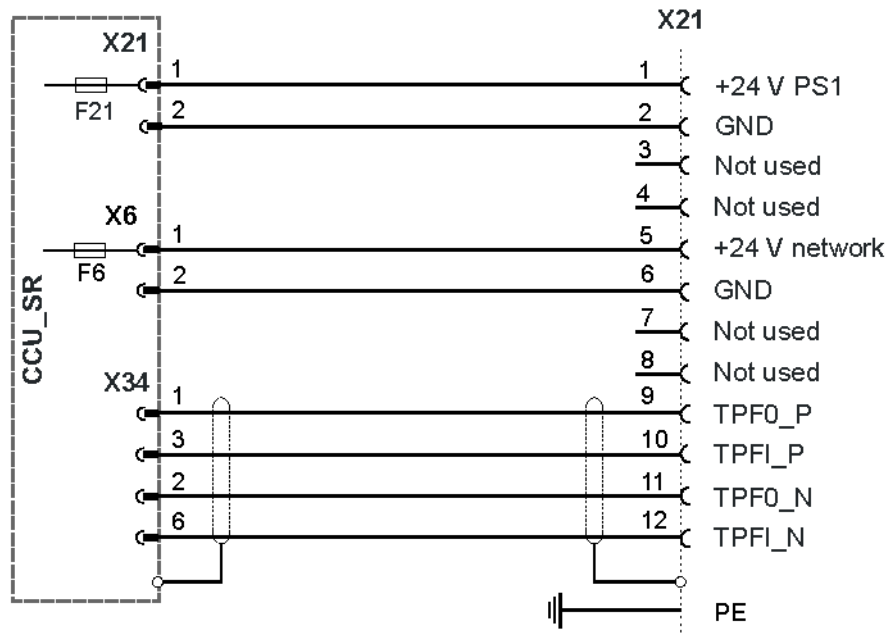

Fig. 8-2: Connector pin allocation for X21

## 8.4 Plugging in the KUKA smartPAD

### Procedure

- Plug the KUKA smartPAD to X19 on the robot controller.

**WARNING** If the smartPAD is disconnected, the system can no longer be switched off by means of the EMERGENCY STOP device on the smartPAD. For this reason, an external EMERGENCY STOP must be connected to the robot controller. The user is responsible for ensuring that the smartPAD is immediately removed from the system when it has been disconnected. The smartPAD must be stored out of sight and reach of personnel working on the industrial robot. This prevents operational and non-operational EMERGENCY STOP devices from becoming interchanged. Failure to observe these precautions may result in death, injuries or damage to property.

**Connector pin allocation X19**

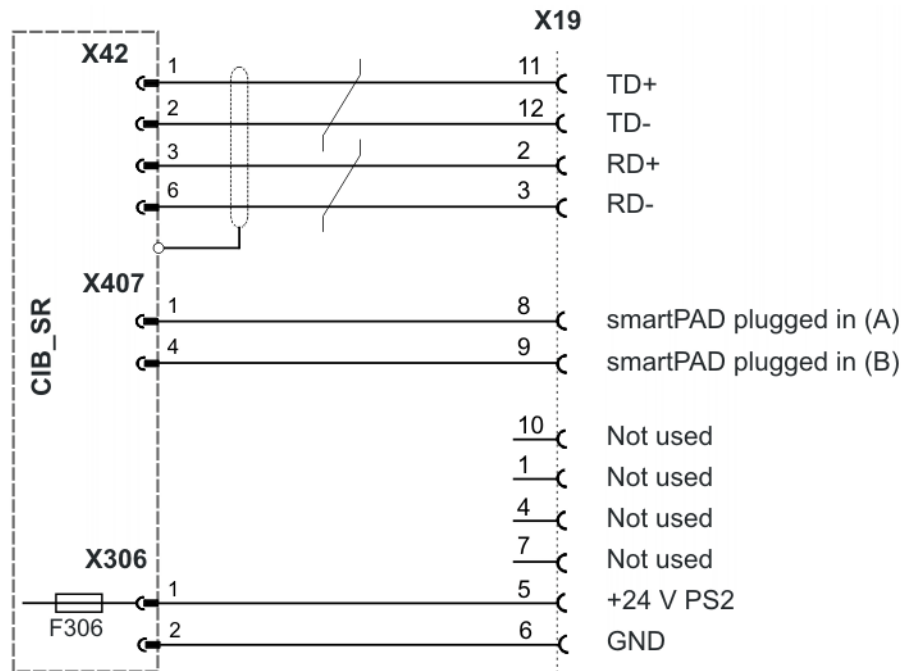

**Fig. 8-3: Connector pin allocation X19**

**8.5 Connecting the PE equipotential bonding**

**Procedure**

1. Route and connect a 4 mm<sup>2</sup> cable as equipotential bonding between the manipulator and the robot controller at the installation site. (>>> 6.11 "PE equipotential bonding" Page 70)  
Route the equipotential bonding by the shortest route from the robot controller to the manipulator.
2. Ground the robot controller at the installation site.
3. Carry out a ground conductor check for the entire robot system in accordance with DIN EN 60204-1.

**8.6 Connecting the robot controller to the power supply**

**Description**

The robot controller is connected to the mains via a 3-pole socket for non-heating apparatus connector.

**Precondition**

- Robot controller is switched off.
- The power cable is de-energized.

**Procedure**

- Connect the robot controller to the mains via power plug.

**8.7 Reversing the battery discharge protection measures**

**Description**

To prevent the batteries from discharging before the controller has been started up for the first time, the robot controller is supplied with connector X305 disconnected from the CCU\_SR.

**Procedure**

- Plug connector X305 into the CCU\_SR.

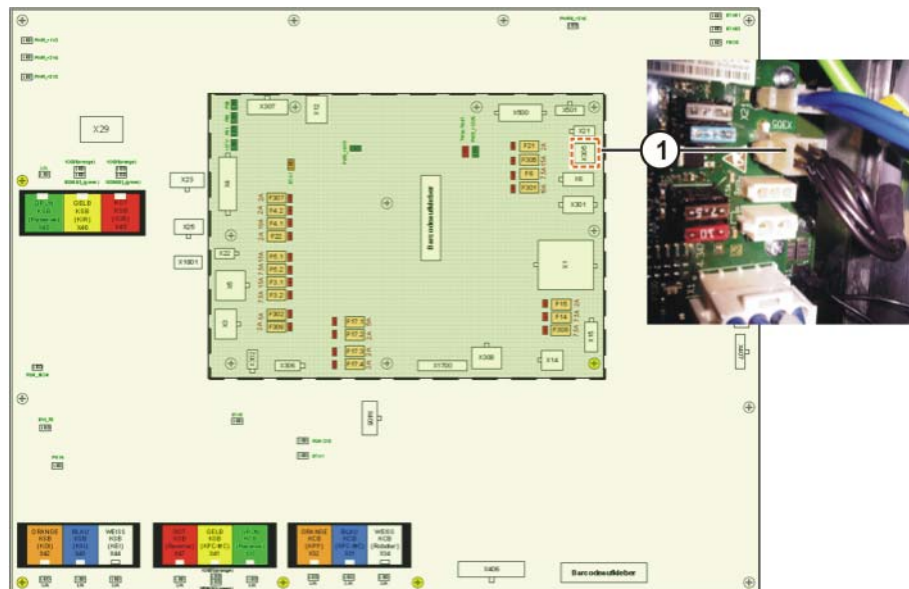

Fig. 8-4: Battery discharge protection X305

- 1 Connector X305 on the CCU\_SR

## 8.8 Configuring and connecting connector X11

**Precondition** ■ The robot controller is switched off.

- Procedure**
1. Configure connector X11 in accordance with the system and safety concepts. (>>> 6.6.1 "Safety interface X11" Page 54)
  2. Connect interface connector X11 to the robot controller.

**NOTICE** Connector X11 may only be plugged in or unplugged when the robot controller is switched off. If connector X11 is plugged in or unplugged when energized, damage to property may occur.

## 8.9 Switching on the robot controller

- Preconditions**
- The manipulator has been installed in accordance with the operating instructions.
  - All electrical connections are correct and the energy levels are within the specified limits.
  - The housing of the robot controller must be closed.
  - The peripheral devices are correctly connected.
  - It must be ensured that no persons or objects are present within the danger zone of the manipulator.
  - All safety devices and protective measures are complete and fully functional.
  - The internal temperature of the robot controller must have adapted to the ambient temperature.

- Procedure**
1. Release the E-STOP device on the smartPAD.
  2. Switch on the main switch.
- The control PC begins to run up (load) the operating system and the control software.



Information about operator control of the manipulator using the smart-PAD can be found in the operating and programming instructions for the KUKA System Software.



## 9 Operation

### 9.1 KUKA smartPAD teach pendant

#### 9.1.1 Front view

**Function** The smartPAD is the teach pendant for the industrial robot. The smartPAD has all the operator control and display functions required for operating and programming the industrial robot.

The smartPAD has a touch screen: the smartHMI can be operated with a finger or stylus. An external mouse or external keyboard is not necessary.

#### Overview

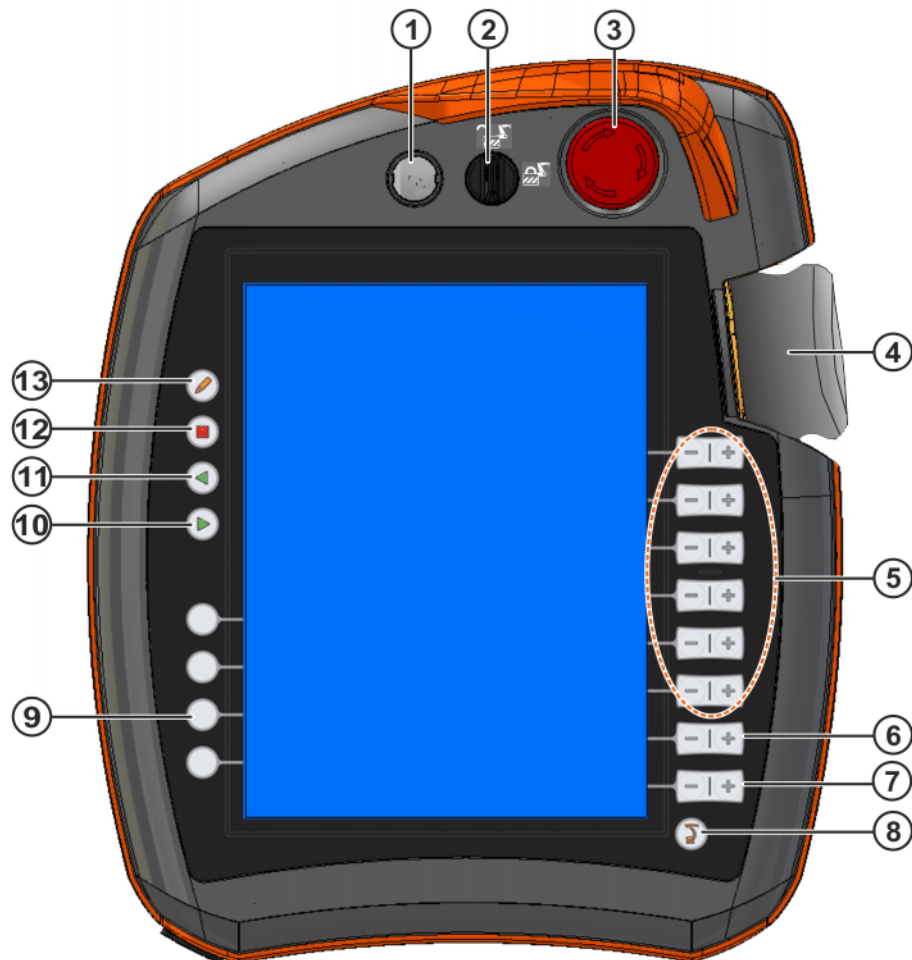

**Fig. 9-1: KUKA smartPAD, front view**

Item	Description
1	Button for disconnecting the smartPAD
2	Keyswitch for calling the connection manager. The switch can only be turned if the key is inserted.  The operating mode can be changed by using the connection manager.

Item	Description
3	EMERGENCY STOP button. Stops the robot in hazardous situations. The EMERGENCY STOP button locks itself in place when it is pressed.
4	Space Mouse: For moving the robot manually.
5	Jog keys: For moving the robot manually.
6	Key for setting the program override
7	Key for setting the jog override
8	Main menu key: Shows the menu items on the smartHMI
9	Status keys. The status keys are used primarily for setting parameters in technology packages. Their exact function depends on the technology packages installed.
10	Start key: The Start key is used to start a program.
11	Start backwards key: The Start backwards key is used to start a program backwards. The program is executed step by step.
12	STOP key: The STOP key is used to stop a program that is running.
13	Keyboard key  Displays the keyboard. It is generally not necessary to press this key to display the keyboard, as the smartHMI detects when keyboard input is required and displays the keyboard automatically.

## 9.1.2 Rear view

## Overview



Fig. 9-2: KUKA smartPAD, rear view

- |   |                   |   |                      |
|---|-------------------|---|----------------------|
| 1 | Enabling switch   | 4 | USB connection       |
| 2 | Start key (green) | 5 | Enabling switch      |
| 3 | Enabling switch   | 6 | Identification plate |

## Description

Element	Description
<b>Identification plate</b>	Identification plate
<b>Start key</b>	The Start key is used to start a program.
<b>Enabling switch</b>	<p>The enabling switch has 3 positions:</p> <ul style="list-style-type: none"> <li>■ Not pressed</li> <li>■ Center position</li> <li>■ Panic position</li> </ul> <p>The enabling switch must be held in the center position in operating modes T1 and T2 in order to be able to jog the manipulator.</p> <p>In the operating modes Automatic and Automatic External, the enabling switch has no function.</p>
<b>USB connection</b>	<p>The USB connection is used, for example, for archiving and restoring data.</p> <p>Only for FAT32-formatted USB sticks.</p>



## 10 Maintenance

**Description** Maintenance work must be performed at the specified maintenance intervals after commissioning at the customer's plant.

### 10.1 Maintenance symbols

#### Maintenance symbols



Oil change



Lubricate with grease gun



Lubricate with brush



Tighten screw/nut



Check component, visual inspection



Clean component



Exchange battery

#### Precondition

- The robot controller must be switched off and secured to prevent unauthorized persons from switching it on again.
- Power supply lead disconnected.
- Observe the ESD guidelines.
- Wait 5 minutes until the intermediate circuit has discharged.

 <b>WARNING</b>	<p>The following components may remain energized (50...600 V) up to 5 minutes after the robot controller has been switched off:</p> <ul style="list-style-type: none"> <li>■ KPP_SR</li> <li>■ KSP_SR</li> <li>■ Intermediate circuit connecting cables</li> <li>■ Connections for motor connector X20 and connected motor cables</li> </ul> <p>This voltage can cause life-threatening injuries.</p>
--	---

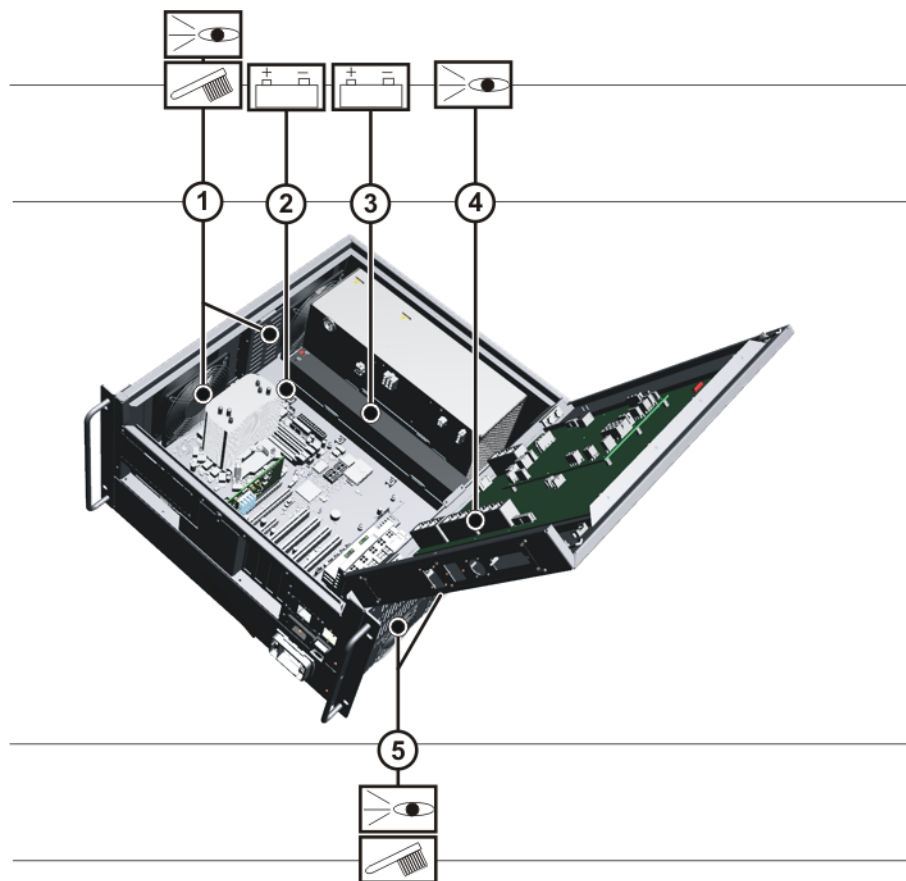

Fig. 10-1: Maintenance points

Interval	Item	Activity
6 months	4	Check the utilized relay outputs of the CCU_SR for correct functioning (>>> 10.2 "Checking CCU_SR relay outputs" Page 86)
1 year at the latest	1/5	Depending on installation conditions and degree of fouling, clean the protective and the fan with a brush.
5 years	2	Exchange the motherboard battery
5 years (with 3-shift operation)	1	Exchange the control box fans (>>> 11.12 "Exchanging the control box fans" Page 98)
	5	Exchange the drive box fans (>>> 11.13 "Exchanging the drive box fans" Page 99)
as indicated by the battery monitoring	3	Exchange the batteries (>>> 11.9 "Exchanging the batteries" Page 95)

Once an activity from the maintenance list has been carried out, a visual inspection must be made, with special attention to the following points:

- Check that fuses, contactors, plug-in connections and boards are fitted securely.
- Damage to cabling.
- Check PE equipotential bonding connection.
- Wear and damage to any system components.

## 10.2 Checking CCU\_SR relay outputs

**Activity** Check the function of the output "Local Emergency Stop".

- Procedure**           ■ Press the Local EMERGENCY STOP button.
- Activity**             Check the function of the output “Operator safety acknowledged”.
- Procedure**           1. Set operating mode to Automatic or Automatic External.  
2. Open operator safety (safeguard).
- Activity**             Check the function of the output “Switch on periphery”.
- Procedure**           1. Set operating mode to Automatic or Automatic External.  
2. Open operator safety (safeguard).  
3. Release enabling switch in “T1” or “T2” mode.
- If no error message is displayed, the relay outputs are OK.

### 10.3 Cleaning the robot controller

- Precondition**       ■ The robot controller must be switched off and secured to prevent unauthorized persons from switching it on again.  
■ Power supply lead disconnected.  
■ Observe the ESD guidelines.
- Work regulations**   ■ The manufacturer’s instructions must be observed when using cleaning agents for cleaning work.  
■ It must be ensured that no cleaning agents enter electrical components.  
■ Do not use compressed air during cleaning work.  
■ Do not spray with water.
- Procedure**           1. Loosen and vacuum up any dust deposits.  
2. Clean the housing with a cloth soaked with a mild cleaning agent.  
3. Clean cables, plastic parts and hoses with a solvent-free cleaning agent.  
4. Replace damaged, illegible or missing inscriptions, labels and plates.





## 11 Repair

### 11.1 Repair and procurement of spare parts

**Repair** Repairs to the robot controller may only be carried out by KUKA customer support personnel or by customers who have taken part in a relevant course of training held by KUKA Roboter GmbH.

Repairs within modules may only be carried out by specially trained KUKA Roboter GmbH personnel.

**Procurement of spare parts** The article numbers of the spare parts are listed in the spare parts catalog. KUKA Roboter GmbH supplies the following types of spare parts for repairs to the robot controller:

- New parts  
Once the new part has been installed, the part that has been removed can be disposed of.
- Exchange parts  
Once the exchange part has been installed, the part that has been removed is returned to KUKA Roboter GmbH.

**i** A “Robot Repair Card” is supplied with the exchange parts. The Repair Card must be completed and returned to KUKA Roboter GmbH.

### 11.2 Opening the housing cover

- Precondition**
- The robot controller must be switched off and secured to prevent unauthorized persons from switching it on again.
  - Power supply lead disconnected.
  - Observe the ESD guidelines.

- Procedure**
1. Unscrew the housing cover screws.

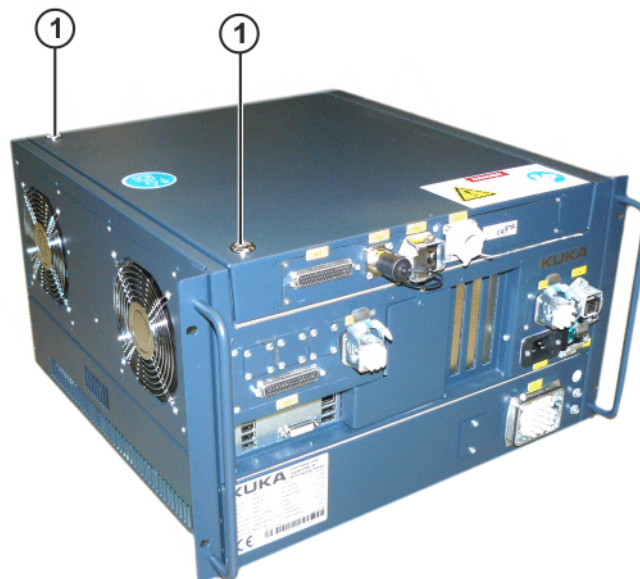

**Fig. 11-1: Housing cover screws**

- 1 Housing cover screws
2. Open the cover.

### 11.3 Removing the control box from the drive box

#### Precondition

- The robot controller must be switched off and secured to prevent unauthorized persons from switching it on again.
- Power supply lead disconnected.
- Observe the ESD guidelines.
- Wait 5 minutes until the intermediate circuit has discharged.



#### WARNING

The following components may remain energized (50...600 V) up to 5 minutes after the robot controller has been switched off:

- KPP\_SR
- KSP\_SR
- Intermediate circuit connecting cables
- Connections for motor connector X20 and connected motor cables

This voltage can cause life-threatening injuries.

#### Procedure

1. Remove the upper fastening screws from the connecting plate on the rear.
2. Remove the upper 3 fastening screws from the handle brackets on the left-hand and right-hand side. Slacken the lower screws.

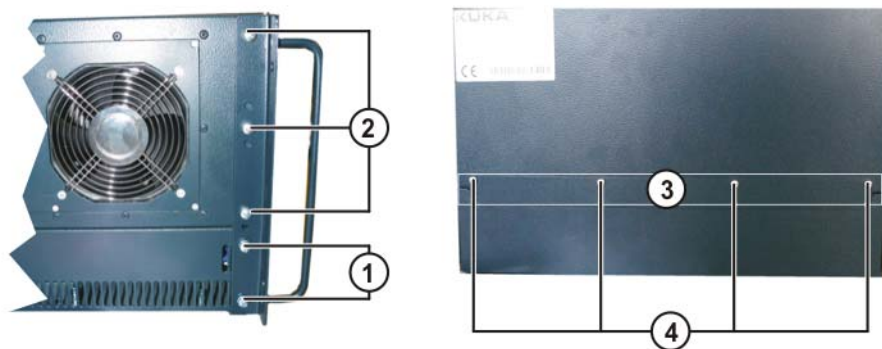

Fig. 11-2: Fastening screws for handle brackets and connecting plate

- 1 Lower fastening screws on the handle bracket
  - 2 Upper fastening screws on the handle bracket
  - 3 Upper fastening screws on the connecting plate at rear
3. Lift the control box and swivel it to the rear.



Fig. 11-3: Drive box and control box separated

- 1 Control box
- 2 Handle brackets

## 11.4 Exchanging the motherboard

A defective motherboard must only be exchanged by the KUKA customer support service.

## 11.5 Exchanging the motherboard battery

- Precondition**
- The robot controller must be switched off and secured to prevent unauthorized persons from switching it on again.
  - Power supply lead disconnected.
  - Observe the ESD guidelines.

- Procedure**
1. Open the housing cover. (>>> 11.2 "Opening the housing cover" Page 89)
  2. Unlock the locking mechanism of the lithium button cell and remove the button cell.

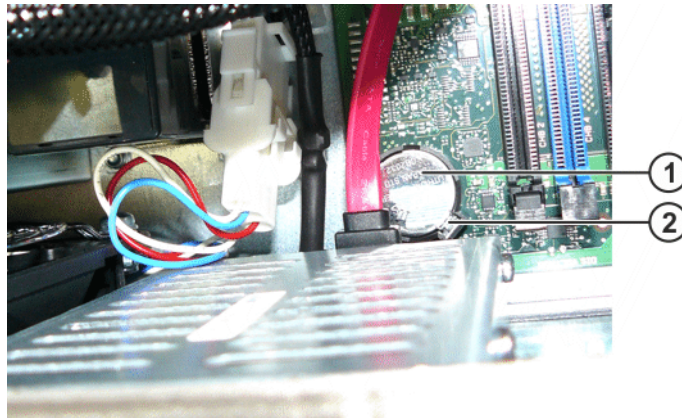

**Fig. 11-4: Lithium button cell**

- 1 Lithium button cell
  - 2 Locking mechanism of lithium button cell
3. Insert the new lithium button cell and click the locking mechanism into place.
  4. Close the housing cover.

## 11.6 Exchanging DIMM memory modules

- Precondition**
- The robot controller must be switched off and secured to prevent unauthorized persons from switching it on again.
  - Power supply lead disconnected.
  - Observe the ESD guidelines.

- Procedure**
1. Open the housing cover. (>>> 11.2 "Opening the housing cover" Page 89)
  2. Using your thumbs, carefully open the side tabs in the direction indicated by the arrows. The DIMM memory module is released and lifted out of its socket.
  3. Press the new DIMM memory module into the slot in the DIMM socket until it clicks into position.

**i** There are two asymmetrically positioned recesses on the underside of the DIMM memory modules; these must mate with the coding on the DIMM socket.

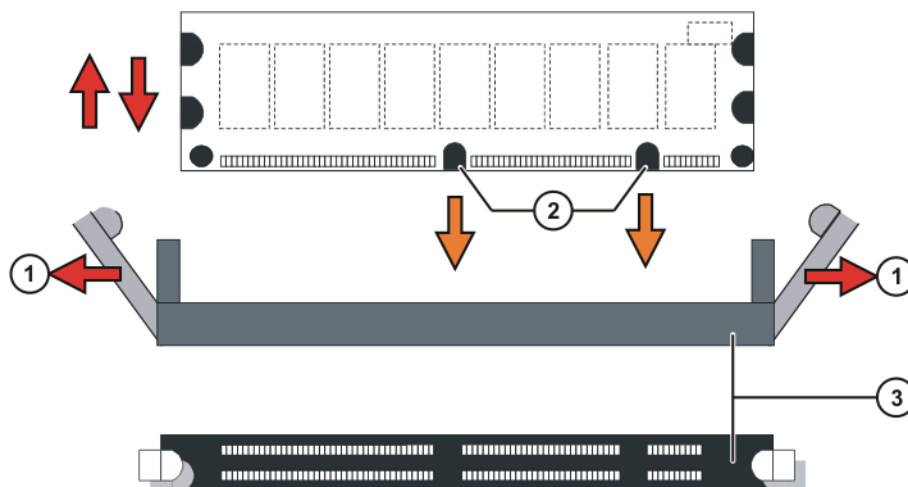

**Fig. 11-5: Exchanging DIMM memory modules**

- |                                      |                             |
|--------------------------------------|-----------------------------|
| 1 Side tabs                          | 3 DIMM memory module socket |
| 2 Asymmetrically positioned recesses |                             |

## 11.7 Exchanging the hard drive

### Precondition

- The robot controller must be switched off and secured to prevent unauthorized persons from switching it on again.
- Power supply lead disconnected.
- Observe the ESD guidelines.

### Procedure

1. Open the housing cover. (>>> 11.2 "Opening the housing cover" Page 89)
2. Disconnect the power supply and data cable.

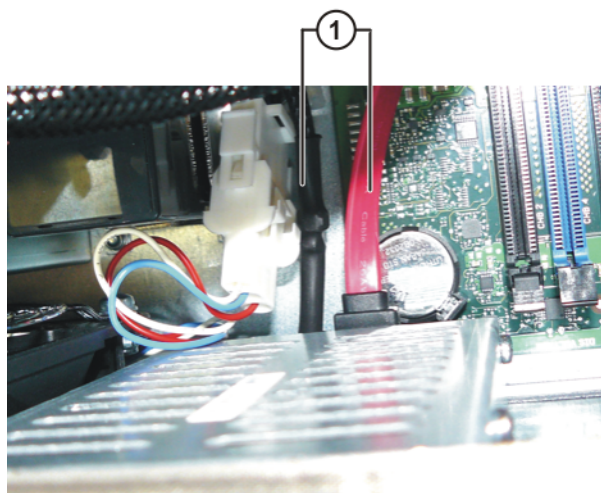

**Fig. 11-6: Hard drive connections**

- 1 Hard drive connections
3. Remove the hard drive retaining screws.

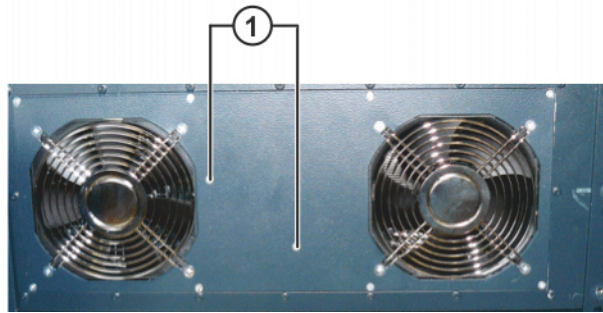
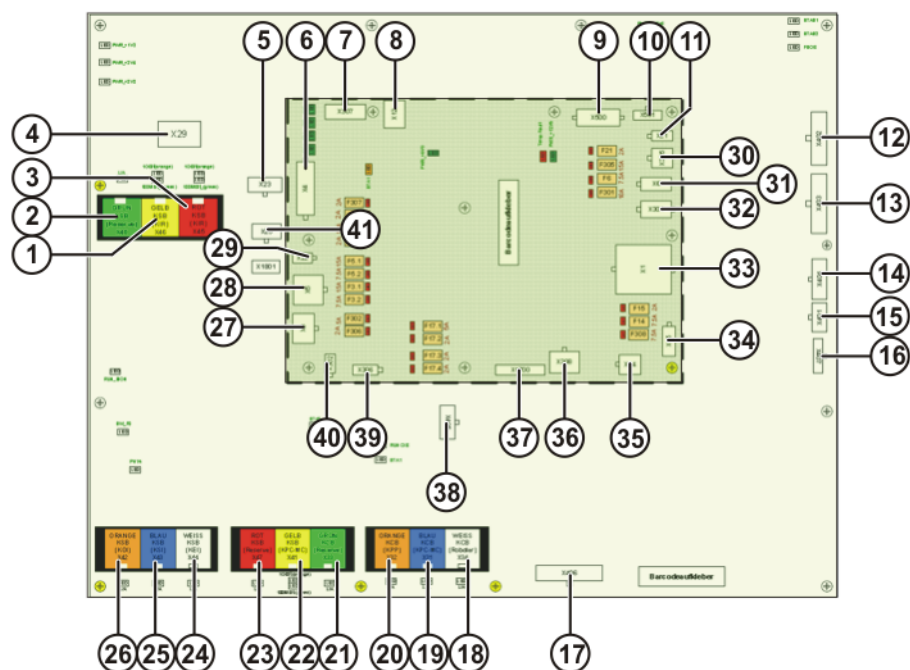

**Fig. 11-7: Hard drive fastening**

- 1 Hard drive fastening
4. Remove the hard drive.
5. Fasten the new hard drive to the housing.
6. Connect the power supply and data cable.
7. Close the housing cover.

## 11.8 Exchanging the Cabinet Control Unit, Small Robot

### Connections



**Fig. 11-8: Connections on the CCU\_SR**

Item	Con- nector	Description
1	X46	KSB RoboTeam (yellow)
2	X48	KSB EtherCAT interface (green), optional
3	X45	KSB RoboTeam (red)
4	X29	EDS connection, memory card
5	X23	Fast Measurement inputs 1 to 5
6	X4	KPC supply and power supply fan
7	X307	UL lamp (optional)
8	X12	USB
9	X500	Not used

Item	Con- nector	Description
10	X501	Not used
11	X21	Power supply to RDC/EMD
12	X402	Safe inputs 1 to 3
13	X403	Safe inputs 4 to 7
14	X404	Safe inputs 8 to 9
15	X401	Mastering reference switch
16	X407	Safe input 11, teach pendant plugged in
17	X406	Safe outputs 12 to 15
18	X34	KCB RDC interface (white)
19	X31	KCB KPC interface (blue)
20	X32	KCB KPP interface (orange)
21	X33	I/O board (optional)
22	X41	KSB KPC interface (yellow)
23	X47	KSB spare (red)
24	X44	KSB KEI (white)
25	X43	KSB - KSI (blue)
26	X42	KSB - KOI (orange)
27	X3	Power supply to KPP_SR logic/brakes
28	X5	Power supply to options
29	X22	Power supply to options
30	X305	Battery infeed
31	X6	I/O board power supply without battery backup (optional)
32	X301	24 V supply, spare
33	X1	Supply
34	X15	Power supply to power supply fan
35	X14	Power supply to external fan
36	X308	External power supply
37	X1700	Board connection to the PMB_SR
38	X405	Safe contactor output 10, single-channel input 10
39	X306	smartPAD power supply
40	X302	I/O board power supply with battery backup (optional)
41	X25	Alarm contact, Power OK, power supply unit

**Precondition**

- The robot controller must be switched off and secured to prevent unauthorized persons from switching it on again.
- Power supply lead disconnected.
- Observe the ESD guidelines.

**Procedure**

1. Unlock the data cable connectors. Unplug all connections to the CCU\_SR.

<b>NOTICE</b>	Unplugging the data cable connectors without first unlocking them damages the connectors. Unlock the connectors before unplugging them.
---------------	---



**Fig. 11-9: Connector locking mechanism of data cable**

- 1 Data connector unlocked
  - 2 Data connector locked
2. Remove the screws from the fastening plate and remove the plate together with the CCU\_SR.

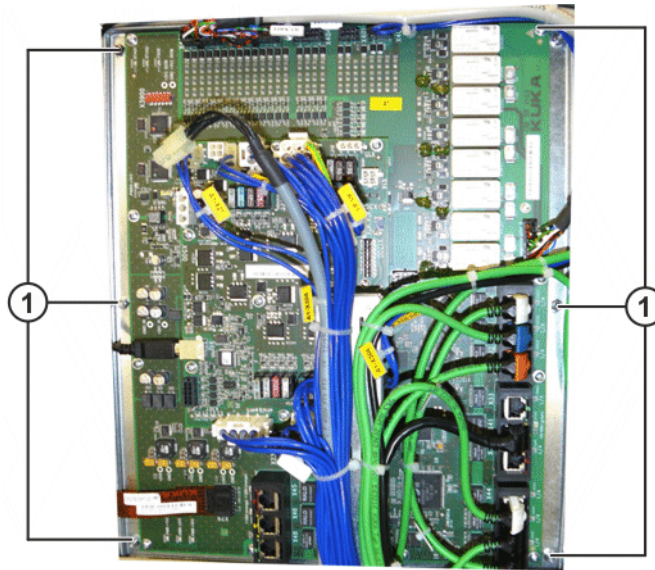

**Fig. 11-10: CCU\_SR fastening**

- 1 CCU\_SR fastening
3. Check the new CCU\_SR for mechanical damage. Insert the fastening plate with the CCU\_SR and screw it down.
  4. Plug in all the connections in accordance with the connector and cable labeling. Lock the data cable connectors.

## 11.9 Exchanging the batteries

- Precondition**
- The robot controller must be switched off and secured to prevent unauthorized persons from switching it on again.
  - Power supply lead disconnected.
  - Observe the ESD guidelines.

- Procedure**
1. Open the housing cover. (>>> 11.2 "Opening the housing cover" Page 89)
  2. Unfasten the Velcro strip.
  3. Unplug the battery connection cables.

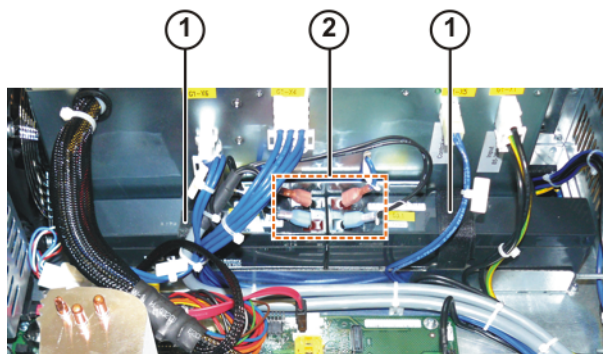
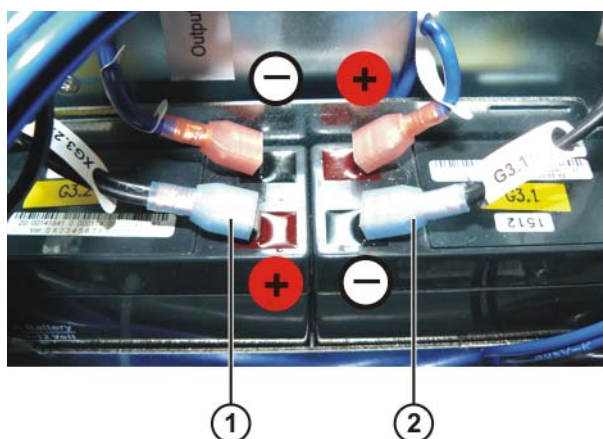

**Fig. 11-11: Battery blocks, fastening and connections**

- 1 Velcro strip for battery fastening
  - 2 Battery connection cables
4. Take out both battery blocks.

**i** The battery blocks must both be exchanged together.

- 5. Insert new battery blocks.
- 6. Fasten the Velcro strip.
- 7. Plug in the battery connection cables in accordance with the cable labels.



**Fig. 11-12: Battery polarity**

- 1 Connection for G3.2
  - 2 Connection for G3.1
8. Close the housing cover.

## Storage

**NOTICE** To prevent exhaustive discharge and thus destruction of the batteries, the batteries must be recharged at regular intervals according to the storage temperature.

If the storage temperature is +20 °C or lower, the batteries must be recharged every 9 months.

If the storage temperature is between +20 °C and +30 °C, the batteries must be recharged every 6 months.

If the storage temperature is between +30 °C and +40 °C, the batteries must be recharged every 3 months.



## 11.10 Exchanging the Dual GbE network card

- Precondition**
- The robot controller must be switched off and secured to prevent unauthorized persons from switching it on again.
  - Power supply lead disconnected.
  - Observe the ESD guidelines.

- Procedure**
1. Open the housing cover. (>>> 11.2 "Opening the housing cover" Page 89)
  2. Remove cover of network connections.
  3. Unplug the connections to the Dual GbE network card.

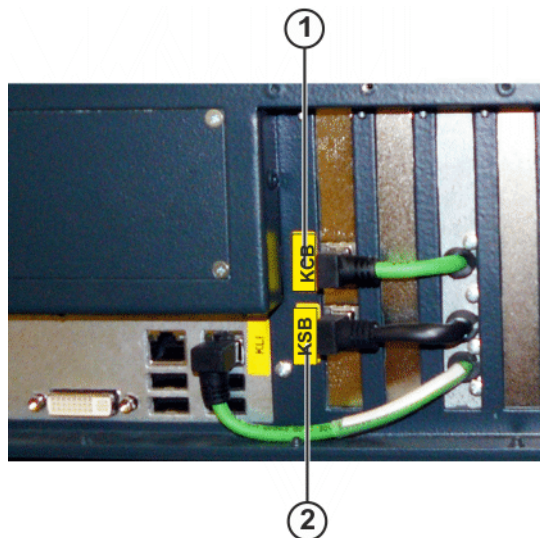

**Fig. 11-13: Dual GbE network card connections**

- 1 Connector KCB
- 2 Connector KSB
4. Release the fastenings of the network card and pull the card out of the slot.
5. Inspect the new network card for mechanical damage.
6. Plug the network card into its slot and tighten the fastening screws.
7. Plug in the connections to the network card.

## 11.11 Exchanging the low-voltage power supply unit

- Precondition**
- The robot controller must be switched off and secured to prevent unauthorized persons from switching it on again.
  - Power supply lead disconnected.
  - Observe the ESD guidelines.
  - Wait 5 minutes until the intermediate circuit has discharged.



**WARNING** The following components may remain energized (50...600 V) up to 5 minutes after the robot controller has been switched off:

- KPP\_SR
  - KSP\_SR
  - Intermediate circuit connecting cables
  - Connections for motor connector X20 and connected motor cables
- This voltage can cause life-threatening injuries.

- Procedure**
1. Open the housing cover. (>>> 11.2 "Opening the housing cover" Page 89)

2. Unplug the connections on the low-voltage power supply unit.
3. Unplug the power supply connections from the low-voltage power supply unit to the motherboard and hard drive.

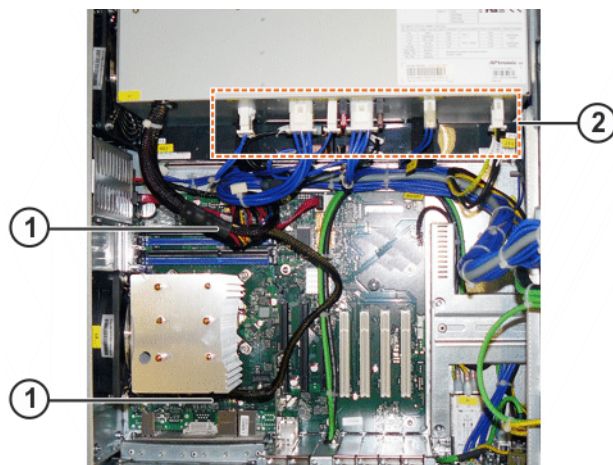

**Fig. 11-14: Connections for low-voltage power supply**

- 1 Connections to the motherboard
- 2 Connections on the low-voltage power supply unit
4. Remove the control box from the drive box. (>>> 11.3 "Removing the control box from the drive box" Page 90)
5. Remove the fastening screws from the low-voltage power supply unit.



**Fig. 11-15: Low-voltage power supply unit, fastening**

- 1 Fastening screws for low-voltage power supply unit
6. Remove the low-voltage power supply unit.
7. Insert and fasten the new low-voltage power supply unit.
8. Plug in the connections on the low-voltage power supply unit, hard drive and motherboard in accordance with the connector and cable labeling.
9. Assemble the drive box and control box.

## 11.12 Exchanging the control box fans

### Precondition

- The robot controller must be switched off and secured to prevent unauthorized persons from switching it on again.
- Power supply lead disconnected.
- Observe the ESD guidelines.

### Procedure

1. Open the housing cover. (>>> 11.2 "Opening the housing cover" Page 89)
2. Remove the fastening screws from the fan holder.

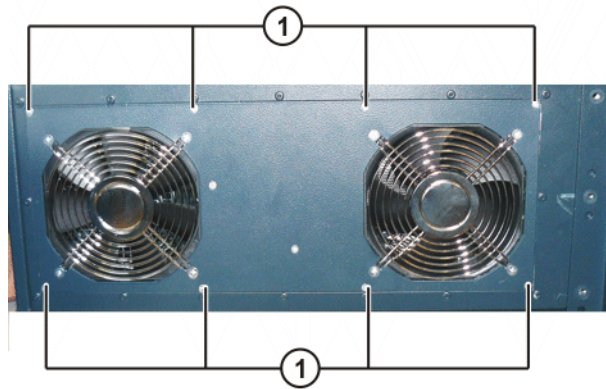

**Fig. 11-16: Fastening of fans**

- 1 Fastening of the fan holder
3. Unplug the fan connections.

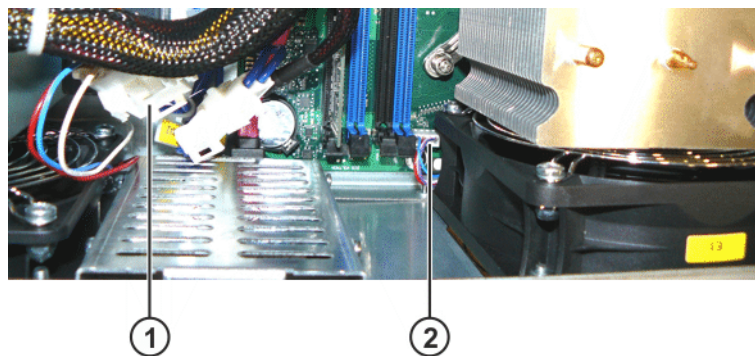

**Fig. 11-17: Connections for fans**

- 1 Connector for motherboard CPU fan
- 2 Connector for fans
4. Remove the fan holder with the fans.
5. Unscrew the inner and outer fan grilles and screw them to the new fans.
6. Install and fasten the new fans with the fan holder.
7. Plug in the connecting cables.

### 11.13 Exchanging the drive box fans

- Precondition**
- The robot controller must be switched off and secured to prevent unauthorized persons from switching it on again.
  - Power supply lead disconnected.
  - Observe the ESD guidelines.
  - Wait 5 minutes until the intermediate circuit has discharged.

**⚠ WARNING** The following components may remain energized (50...600 V) up to 5 minutes after the robot controller has been switched off:

- KPP\_SR
- KSP\_SR
- Intermediate circuit connecting cables
- Connections for motor connector X20 and connected motor cables

This voltage can cause life-threatening injuries.

**Procedure**

1. Remove the control box from the drive box. (>>> 11.3 "Removing the control box from the drive box" Page 90)
2. Remove the fastening screws from the fan holder.

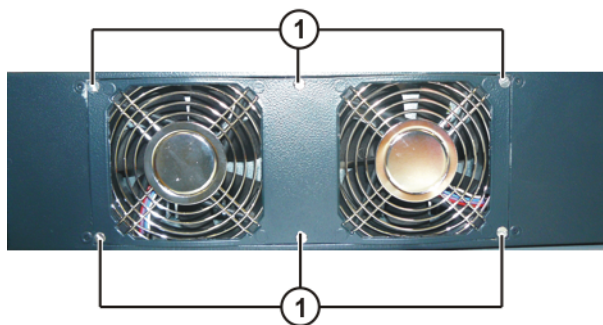
**Fig. 11-18: Fastening of fans**

- 1 Fastening of the fan holder
3. Unplug the fan connections.

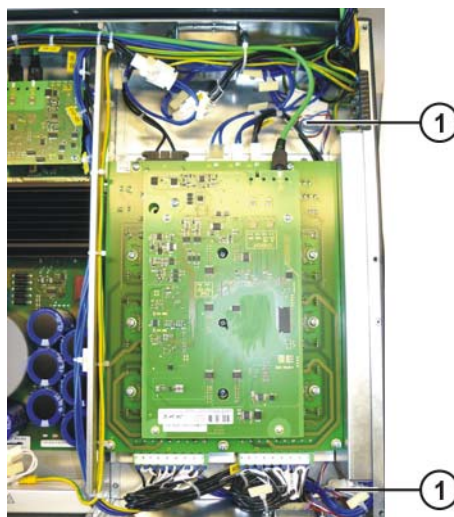
**Fig. 11-19: Connection for fans**

- 1 Connector for fans
4. Remove the fan holder with the fans.
5. Unscrew the fan grille and screw it to the new fans.
6. Install and fasten the new fans with the fan holder.
7. Plug in the connecting cables.

**11.14 Exchanging the KPP\_SR****Precondition**

- The robot controller must be switched off and secured to prevent unauthorized persons from switching it on again.
- Power supply lead disconnected.
- Observe the ESD guidelines.
- Wait 5 minutes until the intermediate circuit has discharged.

**⚠ WARNING** The following components may remain energized (50...600 V) up to 5 minutes after the robot controller has been switched off:

- KPP\_SR
- KSP\_SR
- Intermediate circuit connecting cables
- Connections for motor connector X20 and connected motor cables

This voltage can cause life-threatening injuries.

### Procedure

1. Remove the control box from the drive box. (>>> 11.3 "Removing the control box from the drive box" Page 90)
2. Unplug the connections on the KPP\_SR.
3. Remove the fastening screws of the KPP\_SR board.

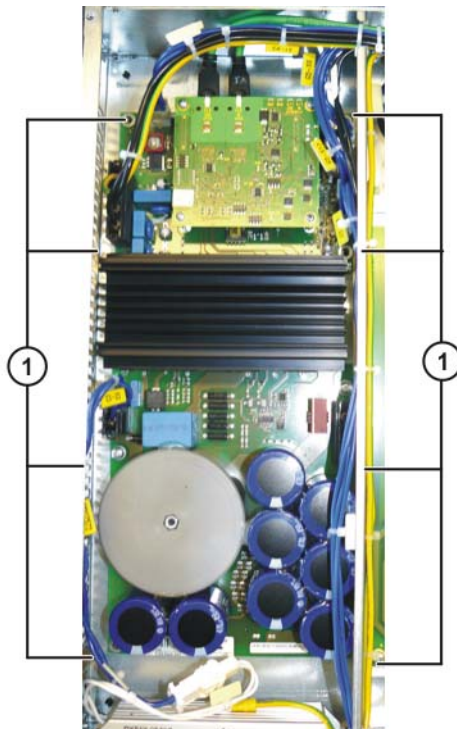

**Fig. 11-20: Fastening the KPP\_SR**

- 1 Fastening screws on the KPP\_SR heat sink
4. Remove the KPP\_SR.
5. Install and fasten the new KPP\_SR.
6. Plug in all the connections in accordance with the connector and cable labeling.
7. Assemble the drive box and control box.

### 11.15 Exchanging the KSP\_SR

#### Precondition

- The robot controller must be switched off and secured to prevent unauthorized persons from switching it on again.
- Power supply lead disconnected.
- Observe the ESD guidelines.
- Wait 5 minutes until the intermediate circuit has discharged.

**⚠ WARNING**

The following components may remain energized (50...600 V) up to 5 minutes after the robot controller has been switched off:

- KPP\_SR
- KSP\_SR
- Intermediate circuit connecting cables
- Connections for motor connector X20 and connected motor cables

This voltage can cause life-threatening injuries.

**Procedure**

1. Remove the control box from the drive box. (>>> 11.3 "Removing the control box from the drive box" Page 90)
2. Unplug the connections on the KSP\_SR.
3. Remove the fastening screws from the KSP\_SR heat sink.

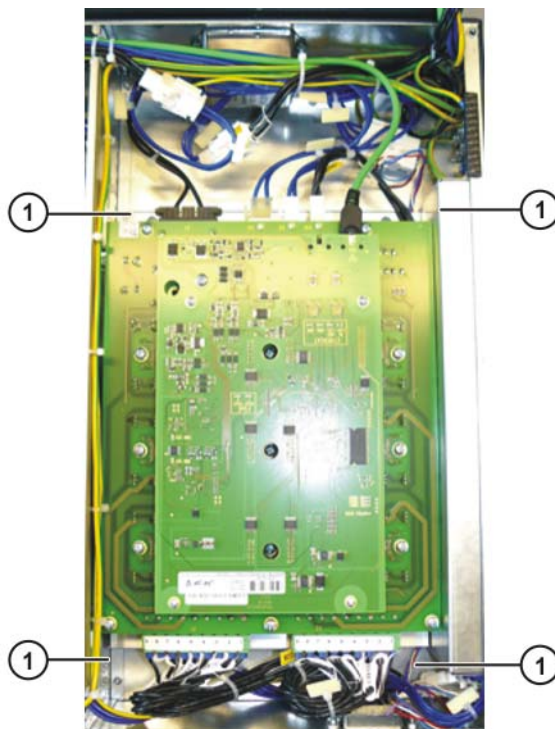

**Fig. 11-21: Fastening the KSP\_SR**

- 1 Fastening screws on the KSP\_SR heat sink
4. Remove the KSP\_SR together with the heat sink.
5. Install and fasten the new KSP\_SR together with the heat sink.
6. Plug in all the connections in accordance with the connector and cable labeling.
7. Assemble the drive box and control box.

### 11.16 Installing the KUKA System Software (KSS)



Further information is contained in the operating and programming instructions for the KUKA System Software (KSS).

## 12 Troubleshooting

### 12.1 LED display on Cabinet Control Unit, Small Robot

#### Overview

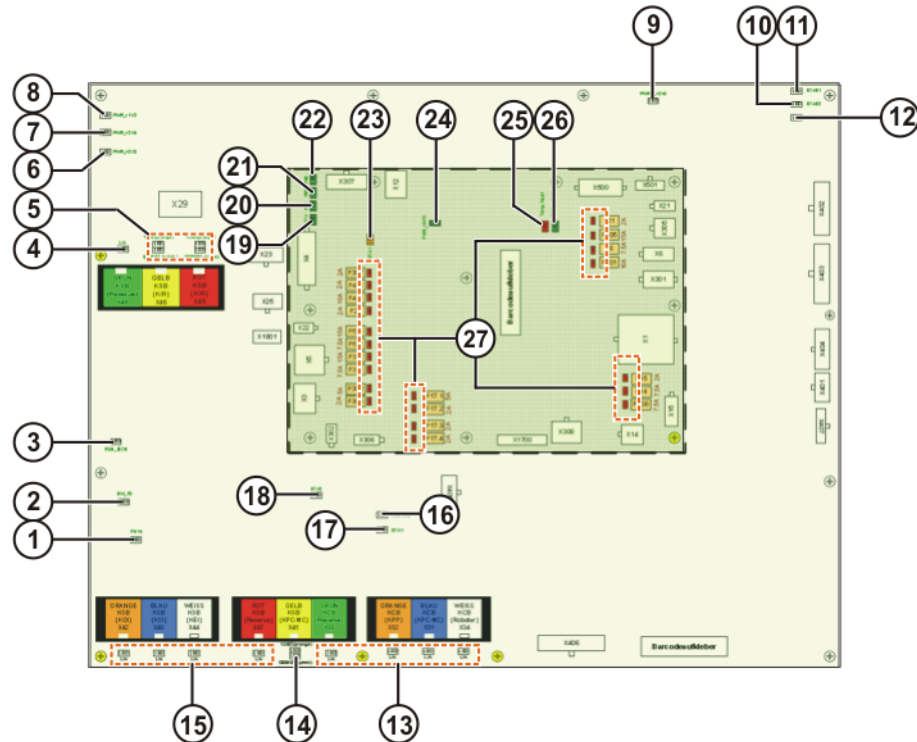

Fig. 12-1: CCU\_SR LED display

Item	Designation	Color	Description	Remedy
1	PHY4	Green	On = OK	-
			Flashing = OK	-
			Off = fault	Exchange CCU_SR module
2	SW_P0	Green	On = OK	-
			Flashing = OK	-
			Off = fault	Exchange CCU_SR module
3	RUN SION EtherCat Safety nodes	Green	On = operational (normal state)	-
			Off = Init (after switching on)	-
			Flashing at 2.5 Hz = Pre-Op (intermediate state on startup)	-
			Single signal = Safe Op	-
			Flashing at 10 Hz = boot (for firmware update)	-
4	L/A KSB	Green	<ul style="list-style-type: none"> <li>■ On = physical connection. Network cable plugged in</li> </ul>	-
5	L/A KSB KPC-MC	Green 100 Mbit	<ul style="list-style-type: none"> <li>■ Off = no physical connection. Network cable not plugged in</li> <li>■ Flashing = data traffic on the line</li> </ul>	
		Orange 1 Gbit		

Item	Designation	Color	Description	Remedy
6	PWR/3.3V Power for the CIB_SR	Green	Off = no supply voltage present	<ul style="list-style-type: none"> <li>■ Check fuse F17.3</li> <li>■ Jumper plug X308 present</li> <li>■ Check fuse F308</li> <li>■ In the case of external supply via X308: check external supply voltage (rated voltage 24 V)</li> </ul>
			On = supply voltage present	-
7	PWR/2.5V Power for the CIB_SR	Green	Off = no supply voltage present	<ul style="list-style-type: none"> <li>■ Check fuse F17.3</li> <li>■ Jumper plug X308 present</li> <li>■ Check fuse F308</li> <li>■ In the case of external supply via X308: check external supply voltage (rated voltage 24 V)</li> </ul>
			On = supply voltage present	-
8	PWR/1.2V Power for the CIB_SR	Green	Off = no supply voltage present	<ul style="list-style-type: none"> <li>■ Check fuse F17.3</li> <li>■ Jumper plug X308 present</li> <li>■ Check fuse F308</li> <li>■ In the case of external supply via X308: check external supply voltage (rated voltage 24 V)</li> </ul>
			On = supply voltage present	-
9	PWRS/3.3V	Green	On = power supply present	-
			Off = no supply voltage present	<ul style="list-style-type: none"> <li>■ Check fuse F17.3</li> <li>■ If the LED PWR/3.3V lights up, exchange the CCU_SR module</li> </ul>
10	STAS2 Safety node B	Orange	Off = no supply voltage present	<ul style="list-style-type: none"> <li>■ Check fuse F17.3</li> <li>■ If the LED PWR/3.3V lights up, exchange the CCU_SR module</li> </ul>
			Flashing at 1 Hz = normal state	-
			Flashing at 10 Hz = boot phase	-
			Flashing = fault code (internal)	Check cabling at X309, X310, X312. For test purposes, disconnect the cables at X309, X310, X312 and switch the controller off and back on again. If the error recurs, exchange the module.



Item	Designation	Color	Description	Remedy
11	STAS1 Safety node A	Orange	Off = no supply voltage present	<ul style="list-style-type: none"> <li>■ Check fuse F17.3</li> <li>■ If the LED PWR/3.3V lights up, exchange the CCU_SR module</li> </ul>
			Flashing at 1 Hz = normal state	-
			Flashing at 10 Hz = boot phase	-
			Flashing = fault code (internal)	Check cabling at X309, X310, X312. For test purposes, disconnect the cables at X309, X310, X312 and switch the controller off and back on again. If the error recurs, exchange the module.
12	FSoE Safety protocol of the EtherCat connection	Green	Off = not active	-
			On = operational	-
			Flashing = fault code (internal)	-
13	L/A KCB	Green	<ul style="list-style-type: none"> <li>■ On = physical connection</li> <li>■ Off = no physical connection. Network cable not plugged in.</li> <li>■ Flashing = data traffic on the line</li> </ul>	-
14	KSB smartPAD_MC	Green 100 Mbit		
		Orange 1 Gbit		
15	L/A KSB	Green		
16	RUN CIB_SR EtherCat AT $\mu$ C I/O node	Green	On = operational (normal state)	-
			Off = Init (after switching on)	-
			Flashing at 2.5 Hz = Pre-Op (intermediate state on startup)	-
			Single signal = Safe Op	-
			10 Hz = boot (for firmware update)	-
17	STA1 (CIB_SR) $\mu$ C I/O node	Orange	Off = no supply voltage present	<ul style="list-style-type: none"> <li>■ Check fuse F17.3</li> <li>■ If the LED PWR/3.3V lights up, exchange the CCU_SR module</li> </ul>
			Flashing at 1 Hz = normal state	-
			Flashing at 10 Hz = boot phase	-
			Flashing = fault code (internal)	Exchange CCU_SR module

Item	Designation	Color	Description	Remedy
18	STA2 FPGA node	Orange	Off = no supply voltage present	<ul style="list-style-type: none"> <li>■ Check infeed at X1</li> <li>■ If the LED PWR/3.3V lights up, exchange the CCU_SR module</li> </ul>
			Flashing at 1 Hz = normal state	
			Flashing at 10 Hz = boot phase	
			Flashing = fault code (internal)	Exchange CCU_SR module
19	27 V Voltage, main power supply unit, without battery backup	Green	Off = no supply voltage present	Check infeed at X1 (rated voltage 27.1 V)
			On = power supply present	-
20	PS1 Voltage, Power Supply 1 (short battery backup)	Green	Off = no supply voltage present	<ul style="list-style-type: none"> <li>■ Check infeed at X1 (rated voltage 27.1 V)</li> <li>■ Drive bus switched off (BusPowerOff state)</li> </ul>
			On = power supply present	-
21	PS2 Voltage, Power Supply 2 (medium battery backup)	Green	Off = no supply voltage present	<ul style="list-style-type: none"> <li>■ Check infeed at X1.</li> <li>■ Controller in Sleep state</li> </ul>
			On = power supply present	-
22	PS3 Voltage, Power Supply 3 (long battery backup)	Green	Off = no supply voltage present	On = power supply present
			On = power supply present	-
23	STA1 (PMB_SR) µC USB	Orange	Off = no supply voltage present	<ul style="list-style-type: none"> <li>■ Check infeed at X1</li> <li>■ If the LED PWR/5V lights up, exchange the CCU_SR module</li> </ul>
			Flashing at 1 Hz = normal state	-
			Flashing at 10 Hz = boot phase	-
			Flashing = fault code (internal)	Exchange CCU_SR module
24	PWR/5V Power supply for PMB_SR	Green	Off = no supply voltage present	Check infeed at X1 (rated voltage 27.1 V)
			Flashing at 1 Hz = normal state	-
			Flashing at 10 Hz = boot phase	-
			Flashing = fault code (internal)	-

Item	Designation	Color	Description	Remedy
25	-	-	Not used	--
26	-	-	Not used	
27	Fuse LEDs  The LEDs indicate the status of the fuses.	Red	On = fuse defective	Exchange defective fuse
			Off = fuse OK	-

## 12.2 Fuses on the Cabinet Control Unit, Small Robot

### Overview

**i** A defective fuse is indicated by a red LED next to the fuse. Once the cause of the fault has been eliminated, defective fuses must be replaced with fuses with the value specified in the operating instructions or printed on the module.

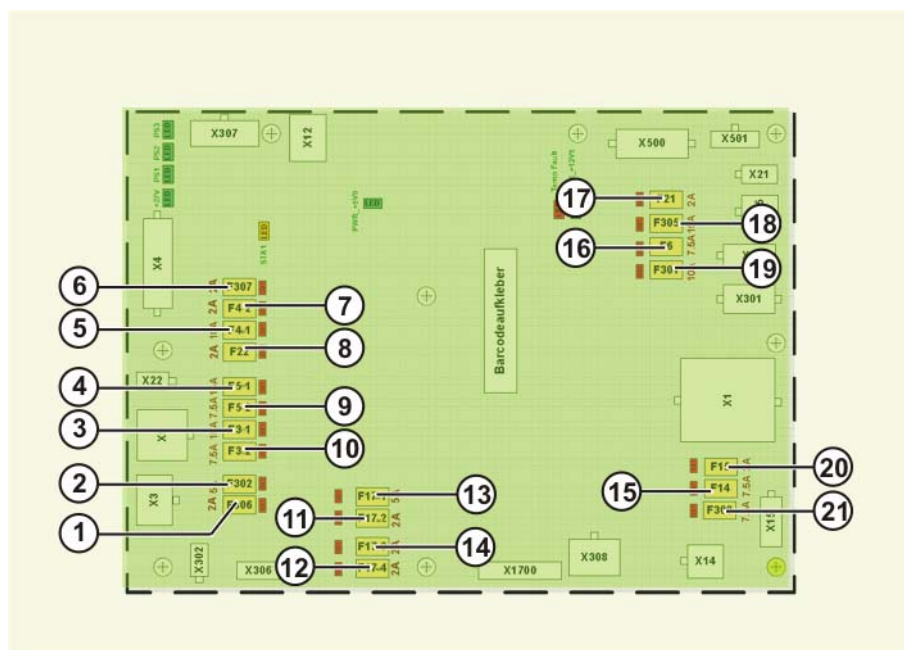

**Fig. 12-2: Arrangement of the fuses**

Item	Designation	Description	Fusing
1	F306	smartPAD power supply	2 A
2	F302	I/O board power supply (optional)	5 A
3	F3-1	KPP_SR and KSP_SR brakes without battery backup	15 A
4	F5-1	24 V without battery backup, for options	15 A
5	F4-1	KPC with battery backup	10 A
6	F307	UL lamp (optional)	2 A
7	F4-2	24 V with battery backup, for fans	2 A
8	F22	24 V without battery backup, for options	7.5 A
9	F5-2	24 V with battery backup, for options	7.5 A

Item	Designation	Description	Fusing
10	F3-2	KPP_SR and KSP_SR logic with battery backup	7.5 A
11	F17-2	Inputs CCU_SR	2 A
12	F17-4	Safe inputs and relays CCU_SR	2 A
13	F17-1	Contactors outputs 1 ... 4 CCU_SR	5 A
14	F17-3	Logic CCU_SR	2 A
15	F14	External fans (optional)	7.5 A
16	F6	I/O board power supply (optional)	7.5 A
17	F21	RDC power supply	3 A
18	F305	Battery infeed	15 A
19	F301	24 V without battery backup, for options	10 A
20	F15	Power supply unit fan	2 A
21	F308	External power supply	7.5 A

## 13 Decommissioning, storage and disposal

### 13.1 Decommissioning

**Description** This section describes all the work required for decommissioning the robot controller if the robot controller is to be removed from the system. After decommissioning, it is prepared for storage or for transportation to a different location.

Following its removal, the robot controller may only be transported with lifting tackle and a fork lift truck or pallet truck.

**Precondition**

- The removal site must be accessible with a crane or with a fork lift truck for transportation.
- The crane and fork lift truck have an adequate carrying capacity.
- There is no hazard posed by system components.

**Procedure**

1. Release and unplug all peripheral connections.
2. Release and unplug motor cable connector and control cable connector.
3. Disconnect the ground conductor.
4. Prepare the robot controller for storage.

### 13.2 Storage

**Preconditions** If the robot controller is to be put into long-term storage, the following points must be observed:

- The place of storage must be as dry and dust-free as possible.
- Avoid temperature fluctuations.
- Avoid wind and drafts.
- Avoid condensation.
- Observe and comply with the permissible temperature ranges for storage.
- Select a storage location in which the packaging materials cannot be damaged.
- Only store the robot controller indoors.

**Procedure**

1. Clean robot controller. No dirt may remain on or in the robot controller.
2. Inspect the robot controller, both internally and externally, for damage.
3. Remove batteries and store in accordance with the manufacturer's instructions.
4. Remove any foreign bodies.
5. Remove any corrosion expertly.
6. Attach all covers to the robot controller and check that the seals are correctly in place.
7. Seal off electrical connections with suitable covers.
8. Cover the robot controller with plastic film and seal it against dust.  
If necessary, add a desiccant beneath the sheeting.

### 13.3 Disposal

When the robot controller reaches the end of its useful life, it can be dismantled, and the materials can be disposed of properly by type.

The following table provides an overview of the materials used in the robot controller. Some of the plastic components are marked with a material designation and must be disposed of accordingly.



As the end user, the customer is legally required to return depleted batteries. Used batteries can be returned to the vendor or brought to the designated collection points (e.g. in communal refuse collection facilities or commercial centers) free of charge. The batteries can also be sent to the vendor by post.

The following symbols can be found on the batteries:

- Crossed-out garbage can: battery must not be disposed of with ordinary household refuse.



- Pb: battery contains more than 0.004 lead by weight.
- Cd: battery contains more than 0.002 cadmium by weight.
- Hg: battery contains more than 0.0005 mercury by weight.

Material, designation	Subassembly, component	Note
Steel-plate components	Screws and washers, robot controller housing	-
PUR	Cable sheaths	-
Plastic parts	Flexible tube	-
Cable	Electrical cables, wires, copper	-
EPDM	Seals and covers	-
CuZn (gold-plated)	Connectors, contacts	Dispose of without dismantling
Steel (ST 52-3)	Allen screws, washers	-
PE	Cable straps	-
Electrical components	Bus modules, boards, sensors	Dispose of as electrical scrap without disassembling
Mains filter		
Fans		
Adhesive labels		
Lead battery		

## 14 KUKA Service

### 14.1 Requesting support

<b>Introduction</b>	This documentation provides information on operation and operator control, and provides assistance with troubleshooting. For further assistance, please contact your local KUKA subsidiary.
<b>Information</b>	<p>The following information is required for processing a support request:</p> <ul style="list-style-type: none"> <li>■ Model and serial number of the manipulator</li> <li>■ Model and serial number of the controller</li> <li>■ Model and serial number of the linear unit (if present)</li> <li>■ Model and serial number of the energy supply system (if present)</li> <li>■ Version of the system software</li> <li>■ Optional software or modifications</li> <li>■ Diagnostic package <b>KrcDiag</b>:            Additionally for KUKA Sunrise: Existing projects including applications            For versions of KUKA System Software older than V8: Archive of the software (<b>KrcDiag</b> is not yet available here.)</li> <li>■ Application used</li> <li>■ External axes used</li> <li>■ Description of the problem, duration and frequency of the fault</li> </ul>

### 14.2 KUKA Customer Support

<b>Availability</b>	KUKA Customer Support is available in many countries. Please do not hesitate to contact us if you have any questions.
<b>Argentina</b>	<p>Ruben Costantini S.A. (Agency)          Luis Angel Huergo 13 20          Parque Industrial          2400 San Francisco (CBA)          Argentina          Tel. +54 3564 421033          Fax +54 3564 428877          ventas@costantini-sa.com</p>
<b>Australia</b>	<p>Headland Machinery Pty. Ltd.          Victoria (Head Office &amp; Showroom)          95 Highbury Road          Burwood          Victoria 31 25          Australia          Tel. +61 3 9244-3500          Fax +61 3 9244-3501          vic@headland.com.au          www.headland.com.au</p>

<b>Belgium</b>	KUKA Automatisering + Robots N.V. Centrum Zuid 1031 3530 Houthalen Belgium Tel. +32 11 516160 Fax +32 11 526794 info@kuka.be www.kuka.be
<b>Brazil</b>	KUKA Roboter do Brasil Ltda. Travessa Claudio Armando, nº 171 Bloco 5 - Galpões 51/52 Bairro Assunção CEP 09861-7630 São Bernardo do Campo - SP Brazil Tel. +55 11 4942-8299 Fax +55 11 2201-7883 info@kuka-roboter.com.br www.kuka-roboter.com.br
<b>Chile</b>	Robotec S.A. (Agency) Santiago de Chile Chile Tel. +56 2 331-5951 Fax +56 2 331-5952 robotec@robotec.cl www.robotec.cl
<b>China</b>	KUKA Robotics China Co.,Ltd. Songjiang Industrial Zone No. 388 Minshen Road 201612 Shanghai China Tel. +86 21 6787-1888 Fax +86 21 6787-1803 www.kuka-robotics.cn
<b>Germany</b>	KUKA Roboter GmbH Zugspitzstr. 140 86165 Augsburg Germany Tel. +49 821 797-4000 Fax +49 821 797-1616 info@kuka-roboter.de www.kuka-roboter.de



**France** KUKA Automatismes + Robotique SAS  
Techvallée  
6, Avenue du Parc  
91140 Villebon S/Yvette  
France  
Tel. +33 1 6931660-0  
Fax +33 1 6931660-1  
commercial@kuka.fr  
www.kuka.fr

**India** KUKA Robotics India Pvt. Ltd.  
Office Number-7, German Centre,  
Level 12, Building No. - 9B  
DLF Cyber City Phase III  
122 002 Gurgaon  
Haryana  
India  
Tel. +91 124 4635774  
Fax +91 124 4635773  
info@kuka.in  
www.kuka.in

**Italy** KUKA Roboter Italia S.p.A.  
Via Pavia 9/a - int.6  
10098 Rivoli (TO)  
Italy  
Tel. +39 011 959-5013  
Fax +39 011 959-5141  
kuka@kuka.it  
www.kuka.it

**Japan** KUKA Robotics Japan K.K.  
YBP Technical Center  
134 Godo-cho, Hodogaya-ku  
Yokohama, Kanagawa  
240 0005  
Japan  
Tel. +81 45 744 7691  
Fax +81 45 744 7696  
info@kuka.co.jp

**Canada** KUKA Robotics Canada Ltd.  
6710 Maritz Drive - Unit 4  
Mississauga  
L5W 0A1  
Ontario  
Canada  
Tel. +1 905 670-8600  
Fax +1 905 670-8604  
info@kukarobotics.com  
www.kuka-robotics.com/canada

<b>Korea</b>	KUKA Robotics Korea Co. Ltd. RIT Center 306, Gyeonggi Technopark 1271-11 Sa 3-dong, Sangnok-gu Ansan City, Gyeonggi Do 426-901 Korea Tel. +82 31 501-1451 Fax +82 31 501-1461 info@kukakorea.com
<b>Malaysia</b>	KUKA Robot Automation Sdn Bhd South East Asia Regional Office No. 24, Jalan TPP 1/10 Taman Industri Puchong 47100 Puchong Selangor Malaysia Tel. +60 3 8061-0613 or -0614 Fax +60 3 8061-7386 info@kuka.com.my
<b>Mexico</b>	KUKA de México S. de R.L. de C.V. Progreso #8 Col. Centro Industrial Puente de Vigas Tlalnepantla de Baz 54020 Estado de México Mexico Tel. +52 55 5203-8407 Fax +52 55 5203-8148 info@kuka.com.mx www.kuka-robotics.com/mexico
<b>Norway</b>	KUKA Sveiseanlegg + Roboter Sentrumsvegen 5 2867 Hov Norway Tel. +47 61 18 91 30 Fax +47 61 18 62 00 info@kuka.no
<b>Austria</b>	KUKA Roboter CEE GmbH Gruberstraße 2-4 4020 Linz Austria Tel. +43 7 32 78 47 52 Fax +43 7 32 79 38 80 office@kuka-roboter.at www.kuka.at

**Poland** KUKA Roboter Austria GmbH  
Spółka z ograniczoną odpowiedzialnością  
Oddział w Polsce  
Ul. Porcelanowa 10  
40-246 Katowice  
Poland  
Tel. +48 327 30 32 13 or -14  
Fax +48 327 30 32 26  
ServicePL@kuka-roboter.de

**Portugal** KUKA Sistemas de Automatización S.A.  
Rua do Alto da Guerra n° 50  
Armazém 04  
2910 011 Setúbal  
Portugal  
Tel. +351 265 729780  
Fax +351 265 729782  
kuka@mail.telepac.pt

**Russia** KUKA Robotics RUS  
Werbnaja ul. 8A  
107143 Moskau  
Russia  
Tel. +7 495 781-31-20  
Fax +7 495 781-31-19  
info@kuka-robotics.ru  
www.kuka-robotics.ru

**Sweden** KUKA Svetsanläggningar + Robotar AB  
A. Odhners gata 15  
421 30 Västra Frölunda  
Sweden  
Tel. +46 31 7266-200  
Fax +46 31 7266-201  
info@kuka.se

**Switzerland** KUKA Roboter Schweiz AG  
Industriestr. 9  
5432 Neuenhof  
Switzerland  
Tel. +41 44 74490-90  
Fax +41 44 74490-91  
info@kuka-roboter.ch  
www.kuka-roboter.ch

<b>Spain</b>	KUKA Robots IBÉRICA, S.A. Pol. Industrial Torrent de la Pastera Carrer del Bages s/n 08800 Vilanova i la Geltrú (Barcelona) Spain Tel. +34 93 8142-353 Fax +34 93 8142-950 Comercial@kuka-e.com www.kuka-e.com
<b>South Africa</b>	Jendamark Automation LTD (Agency) 76a York Road North End 6000 Port Elizabeth South Africa Tel. +27 41 391 4700 Fax +27 41 373 3869 www.jendamark.co.za
<b>Taiwan</b>	KUKA Robot Automation Taiwan Co., Ltd. No. 249 Pujong Road Jungli City, Taoyuan County 320 Taiwan, R. O. C. Tel. +886 3 4331988 Fax +886 3 4331948 info@kuka.com.tw www.kuka.com.tw
<b>Thailand</b>	KUKA Robot Automation (M)SdnBhd Thailand Office c/o Maccall System Co. Ltd. 49/9-10 Soi Kingkaew 30 Kingkaew Road Tt. Rachatheva, A. Bangpli Samutprakarn 10540 Thailand Tel. +66 2 7502737 Fax +66 2 6612355 atika@ji-net.com www.kuka-roboter.de
<b>Czech Republic</b>	KUKA Roboter Austria GmbH Organisation Tschechien und Slowakei Sezemická 2757/2 193 00 Praha Horní Počernice Czech Republic Tel. +420 22 62 12 27 2 Fax +420 22 62 12 27 0 support@kuka.cz

**Hungary** KUKA Robotics Hungaria Kft.  
Fö út 140  
2335 Taksony  
Hungary  
Tel. +36 24 501609  
Fax +36 24 477031  
info@kuka-robotics.hu

**USA** KUKA Robotics Corporation  
51870 Shelby Parkway  
Shelby Township  
48315-1787  
Michigan  
USA  
Tel. +1 866 873-5852  
Fax +1 866 329-5852  
info@kukarobotics.com  
www.kukarobotics.com

**UK** KUKA Automation + Robotics  
Hereward Rise  
Halesowen  
B62 8AN  
UK  
Tel. +44 121 585-0800  
Fax +44 121 585-0900  
sales@kuka.co.uk



## Index

### Numbers

19" rack 52, 76  
 2004/108/EC 49  
 2006/42/EC 48  
 89/336/EEC 49  
 95/16/EC 48  
 97/23/EC 49

### A

Accessories 11, 27  
 Altitude 21  
 Ambient temperature 21  
 ANSI/RIA R.15.06-2012 49  
 Applied norms and regulations 48  
 Automatic mode 45  
 Axis range 28  
 Axis range limitation 37  
 Axis range monitoring 37

### B

Basic data 21  
 Batteries 14  
 Batteries, exchanging 95  
 Battery discharge protection, reversing 78  
 Brake defect 40  
 Brake release device 38  
 Braking distance 28

### C

Cabinet Control Unit LED display 103  
 Cabinet Control Unit Small Robot, exchange 93  
 Cabinet Control Unit Small Robot, fuses 107  
 Cabinet Control Unit, Small Robot 13  
 Cabinet Interface Board, Small Robot 13, 23  
 Cable lengths 22, 53  
 CCU\_SR 8, 13  
 CCU\_SR functions 13  
 CCU\_SR LED display, overview 103  
 CCU\_SR relay outputs, checking 86  
 CE mark 28  
 Charge 14  
 CIB\_SR 8, 23  
 CIB\_SR inputs 24  
 CIB\_SR outputs 23  
 CIB\_SR, safe input 59  
 CIB\_SR, safe output 60  
 CIP Safety 8  
 Cleaning work 46  
 Connecting cables 11, 27, 76  
 Connecting the power supply 78  
 Connection conditions 52  
 Connection manager 81  
 Connection panel 11  
 Connector pin allocation X20 76  
 Connector pin allocation X65 69  
 Connector pin allocation X65, bus coupler 69  
 Connector pin allocation X66 68  
 Connector pin allocation X69 69

Control box 12  
 Control box fans, exchange 98  
 Control box, removal 90  
 Control PC 11, 12  
 Control PC, functions 13  
 Control unit 22  
 Cooling 19  
 Cooling circuit 19  
 Counterbalancing system 46

### D

Danger zone 29  
 DC 14  
 Declaration of conformity 28  
 Declaration of incorporation 27, 28  
 Decommissioning 47, 109  
 defective fuses 107  
 Description of the industrial robot 11  
 Dimensions 22  
 Dimensions, handle brackets 25  
 Dimensions, smartPAD holder 24  
 Disposal 47, 109  
 Documentation, industrial robot 7  
 Drive box 14  
 Drive box fans, exchange 99  
 Drive Configuration 14  
 Dual GbE network card, exchanging 97  
 Dual NIC card 8  
 Dynamic testing 59

### E

EA 8  
 EC declaration of conformity 28  
 EDS 8  
 Electromagnetic compatibility (EMC) 49  
 Electromagnetic compatibility, EMC 51  
 EMC 8  
 EMC Directive 28, 49  
 EMD 8  
 EMERGENCY STOP 82  
 EMERGENCY STOP device 34, 35, 39  
 EMERGENCY STOP devices to X11 57  
 EMERGENCY STOP wiring example 57  
 EMERGENCY STOP, external 35, 42  
 EMERGENCY STOP, local 42  
 EN 60204-1 + A1 49  
 EN 61000-6-2 49  
 EN 61000-6-4 49  
 EN 614-1 49  
 EN ISO 10218-1 49  
 EN ISO 12100 49  
 EN ISO 13849-1 49  
 EN ISO 13849-2 49  
 EN ISO 13850 49  
 Enabling device 35, 39  
 Enabling device, external 36  
 Enabling switch 83  
 Enabling switches 35, 64

Environmental conditions 21  
EtherCAT interface X65 68  
Ethernet interface (1xRJ45) X66 68  
Exhaustive discharge of battery 21, 96  
External axes 27, 30  
External enabling switch, function 56

**F**

Faults 40  
Filter mats 19  
Function test 42  
Fusing 53

**G**

General safety measures 40  
Guard interlock 33

**H**

Hard drive, exchanging 92  
Hazardous substances 47  
Humidity class 21

**I**

Identification plate 83  
Industrial robot 11, 27  
Infeed 53  
Installation conditions 51  
Installation, KUKA System Software 102  
Installing the robot controller 76  
Intended use 9, 27  
Interfaces 15, 17  
Interfaces, control PC 16  
Introduction 7

**J**

Jog keys 82  
Jog mode 36, 39

**K**

KCB 8  
KEB 8  
KEI 8  
Keyboard 82  
Keyboard key 82  
KLI 8  
KOI 8  
KONI 8  
KPC 8  
KPP\_SR 8  
KPP\_SR, exchange 100  
KRL 8  
KSB 8  
KSI 8  
KSP\_SR 8  
KSP\_SR, exchange 101  
KSS 8  
KUKA Customer Support 111  
KUKA smartPAD 22, 29, 81

**L**

Labeling 38

Liability 27  
Linear unit 27  
Low Voltage Directive 28  
Low-voltage power supply unit 14  
Low-voltage power supply unit, exchanging 97

**M**

Machine data 42  
Machinery Directive 28, 48  
Mains filter 14  
Maintenance 46, 85  
Maintenance symbols 85  
Manipulator 8, 11, 27, 29  
Manual mode 44  
Mastering test 68  
Material designation 110  
Mechanical axis range limitation 37  
Mechanical end stops 37  
Memory modules, exchange 91  
Mode selection 32, 33  
Monitoring, velocity 36  
Motherboard battery, exchange 91  
Motherboard D3076-K 17  
Motherboard D3236-K 18  
Motherboard D3236-K interfaces 18  
Motherboard, exchange 91  
Motherboards 16  
Motor cable, data cable 15

**O**

Opening the housing cover 89  
Operation 81  
Operator 31  
Operator safety 32, 33, 39  
Options 11, 27  
Overload 40  
Overview of planning 51  
Overview of the robot controller 11  
Overview, start-up 75

**P**

Panic position 35  
PE equipotential bonding 70  
PE equipotential bonding, connecting 78  
Performance level 70  
Performance Level 32  
Peripheral cables 15  
Personnel 30  
PFH values 70  
PL 70  
Planning 51  
Planning, overview 51  
Plant integrator 30  
Plates and labels 25  
PMB\_SR 8  
Positioner 27  
Power cable 15  
Power failure 14  
Power Management Board, Small Robot 13  
Power supply connection 53  
Power supply connection, technical data 21, 52



- Power supply with battery backup 14
- Power supply without battery backup 14
- Power switched off 14
- Power unit 11
- Pressure Equipment Directive 47, 49
- Preventive maintenance work 46
- Procurement of spare parts 89
- Product description 11
- Protective equipment 36
- Purpose 9
  
- R**
- RDC 8
- Reaction distance 28
- Recommissioning 41, 75
- Release device 38
- Repair 46, 89
- Resolver cable, length difference 22, 53
- Robot controller 11, 27
- Robot controller, cleaning 87
  
- S**
- Safe operational stop 29, 36
- Safeguard to X11 57
- Safeguards, external 39
- SafeOperation via Ethernet safety interface 65
- Safety 27
- Safety controller 33
- Safety functions 32, 39
- Safety functions, Ethernet safety interface 61
- Safety functions, overview 32
- Safety gate, wiring example 58
- Safety instructions 7
- Safety interface, X11 53
- Safety logic 11
- Safety of machinery 49
- Safety options 29
- Safety STOP 0 29
- Safety STOP 1 29
- Safety STOP 2 29
- Safety STOP 0 29
- Safety STOP 1 29
- Safety STOP 2 29
- Safety stop, external 36
- Safety zone 29, 31
- Safety, general 27
- SATA connections 8
- Service Interface X69 69
- Service life 29
- Service, KUKA Roboter 111
- Signal "Peri enabled" 57
- Simulation 45
- Single point of control 47
- Slot assignment, motherboard D3076-K 17
- Slot assignment, motherboard D3236-K 18
- smartPAD 29, 40, 81
- smartPAD cable 15
- smartPAD cable extensions 22, 53
- smartPAD, plugging in 77
- Software 11, 27
- Software limit switches 37, 39
  
- Space Mouse 82
- SPOC 47
- Start backwards key 82
- Start key 82, 83
- Start-up 41, 75
- Start-up mode 43
- Start-up overview 75
- Status keys 82
- STOP 0 28, 30
- STOP 1 28, 30
- STOP 2 28, 30
- Stop category 0 30
- Stop category 1 30
- Stop category 2 30
- STOP key 82
- Stop reactions 31
- Stopping distance 28
- Storage 47, 109
- Storage of batteries 96
- Support request 111
- Switching on the robot controller 79
- System integrator 28, 30, 31
  
- T**
- T1 30
- T2 30
- Target group 9
- Teach pendant 11, 27
- Technical data 21
- Terms used 8
- Terms used, safety 28
- Touch screen 81
- Trademarks 7
- Training 9
- Transportation 41, 73
- Troubleshooting 103
- Turn-tilt table 27
  
- U**
- USB 8
- USB connection 83
- Use, contrary to intended use 27
- Use, improper 27
- User 29, 30
  
- V**
- Velocity monitoring 36
- Vibration resistance 22
  
- W**
- Warnings 7
- Working range limitation 37
- Workspace 28, 31
  
- X**
- X11 Connector pin allocation 54
- X11, configuring and connecting 79
- X19 connector pin allocation 78
- X21 connector pin allocation 77
- X65 68
- X66 68

X69 69

