

i7C Series DC/DC Power Module Series

9-53V Wide Input, 300W Step-up/Step-down Converter; Wide 1/16th Brick Footprint

i7C power modules step the voltage up or down to perform local voltage conversion between 12V, 24V, or well-regulated 48V buses. The i7C series utilizes a non-isolated power topology offering a low component count and resulting in a low cost structure and a superior level of performance. The open-frame, compact, design features a low profile and weight that allow for extremely flexible and robust manufacturing processes. The ultra-high efficiency allows for a high amount of usable power even in the most demanding thermal environments.

Features

- Size – 34mm x 36.8 mm x 12.7 mm (1.34 in. x 1.45 in. x 0.5 in.)
- Maximum weight 25g (0.88 oz.)
- Through-hole pins 3.68mm (0.145")
- Industry standard 1/16th brick pin locations
- Up to 300W of output power in high ambient temperature, low airflow environments with minimal power de-rating
- Wide output voltage adjustment range
- Negative logic On/Off
- Constant switching frequency
- Remote Sense
- Full, auto-recovery protection
 - Input under voltage
 - Short circuit
 - Thermal limit
- ISO Certified manufacturing facilities

Optional Features

- Positive logic On/Off
- Power Good
- Frequency Synchronization
- Output Current Monitor
- Short 2.79mm (0.110") pin length
- Long 4.57mm (0.180") pin length
- Baseplate
- Heatsink

Ordering Information:

Product Identifier	Package Size	Platform	Input Voltage	Output Current	Units	Main Output Voltage	# of Outputs	Safety Class	Feature Set	RoHS indicator		
i	7	C	4W	012	A	050	V	-	0	01	-	R
TDK Lambda	34mm x 36.8mm	i7C	9V to 53V	008 – 8A 012 – 12A	Amps	5V	Single			See option table		R=RoHS Compliant

Option Table:

Feature Set	Positive Logic On/Off	Negative Logic On/Off	Full Feature (Power Good, Sync, Current Monitor)	0.145" Pin Length (Default)	Integrated Heatsink	Baseplate
-001	-	Yes	-	Yes	-	-
-002	Yes	-	Yes	Yes	-	-
-003	-	Yes	Yes	Yes	-	-
-0C1	-	Yes	-	Yes	-	Yes
-0C3		Yes	Yes	Yes		Yes
-0F1	-	Yes	-	Yes	Yes	-

Product Offering:

Product Code	Input Voltage (V)	Output Voltage (V)	Output Current (A)	Maximum Output Power (W)	Efficiency
i7C4W012A050V	9 - 53	5.0 - 28	12.5	300	97%
i7C4W008A120V	9 - 53	9.6 - 48	8.0	300	97%

Typical Application Circuit:

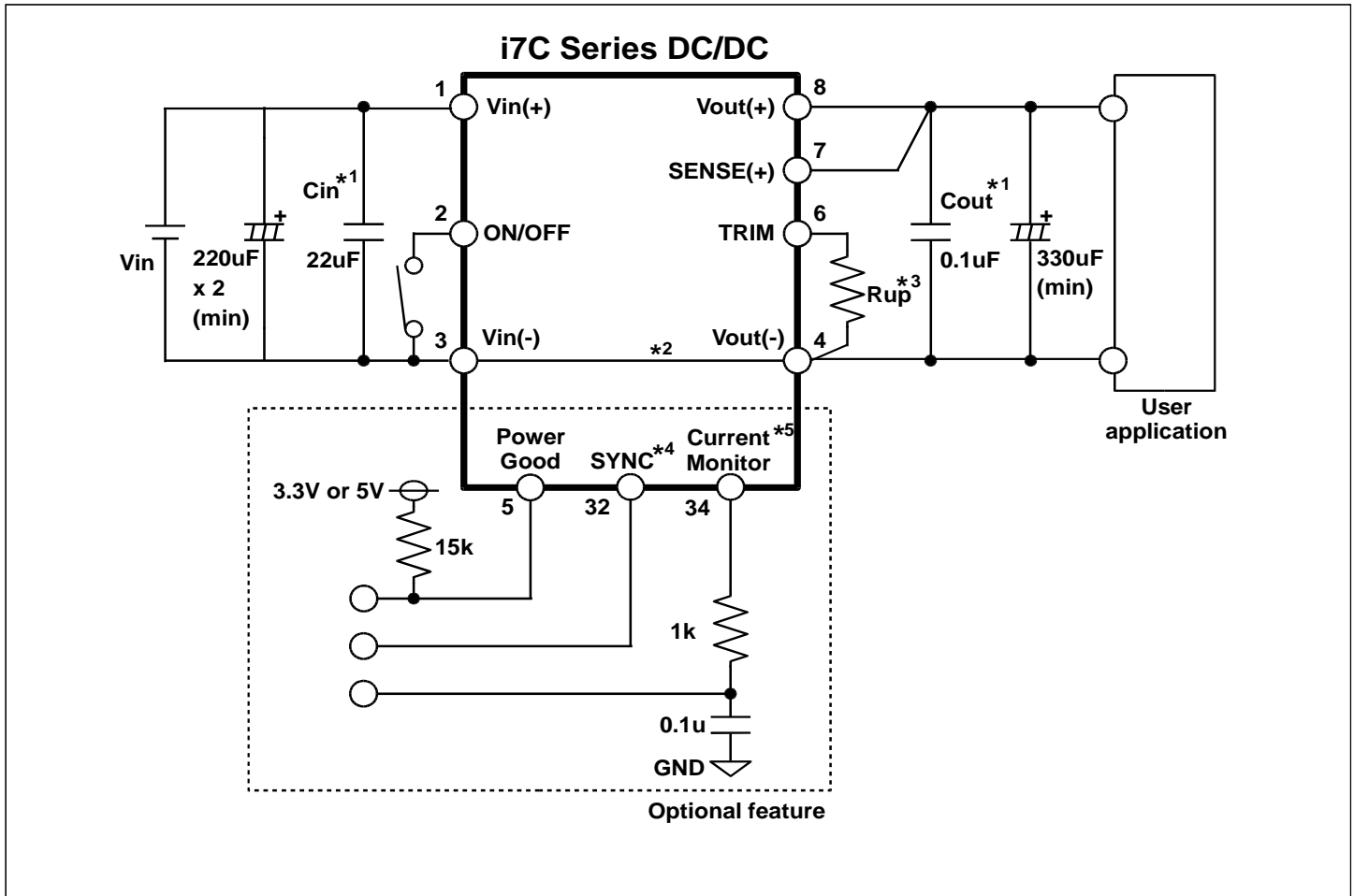

Recommendation

1. C_{in}/C_{out} MLCC should be connected to the i7C module as close as possible in order to reject high frequency noise.
2. Connect $V_{in}(-)$ and $V_{out}(-)$ to copper ground plane underneath the i7C module.
3. TRIM resistor " R_{up} " should be connected to the i7C module as close as possible.
4. SYNC must be connected to GND when not in use.
5. External R-C filter is needed for Current Monitor.

Mechanical Specification: (With Baseplate –xCx-R product options)

Dimensions are in mm [in]. Unless otherwise specified, tolerances are: $x.x \pm 0.5$ [0.02] / $x.xx \pm 0.25$ [0.010]

To avoid damaging components, do not exceed 8.0 [0.32] depth with M3 screws

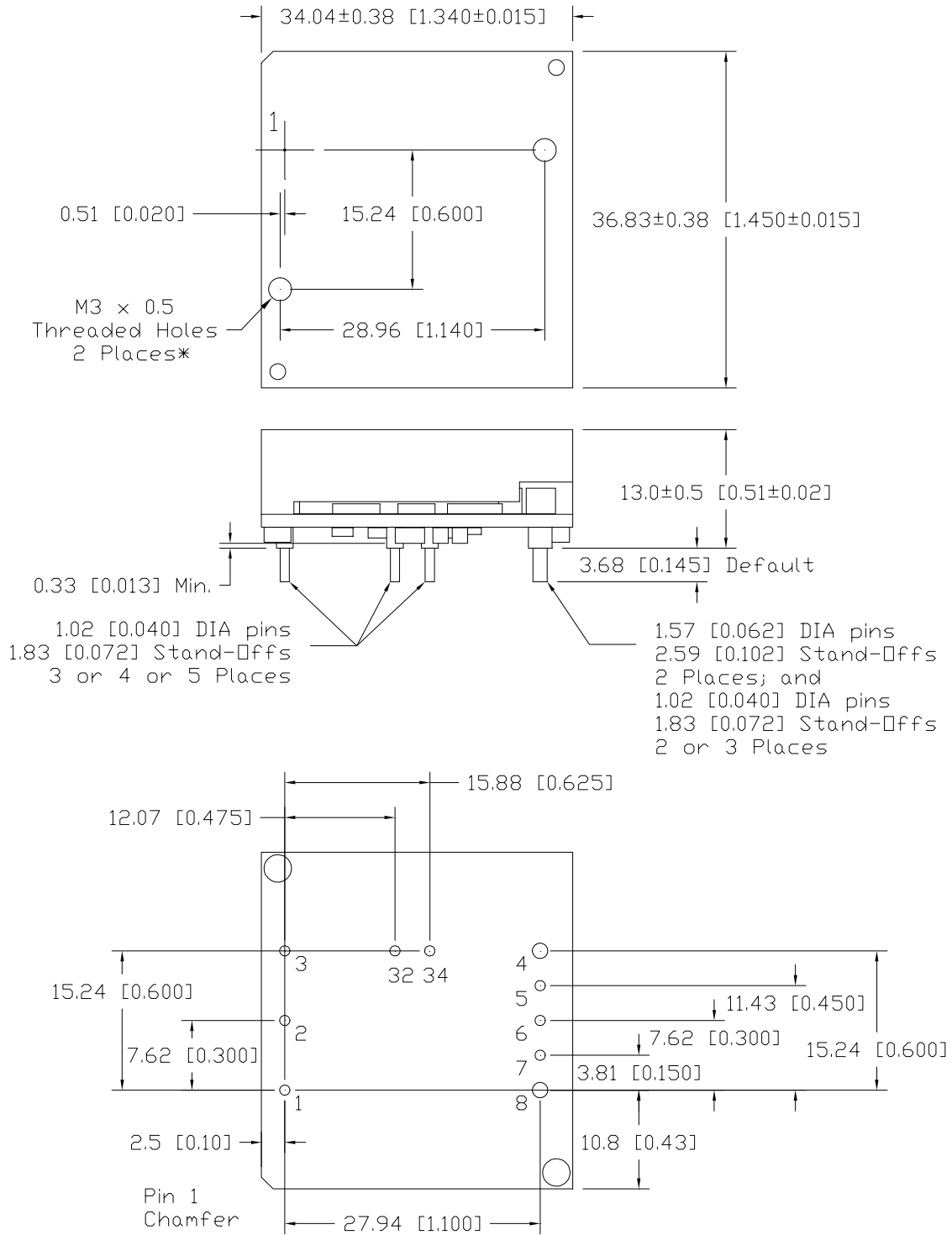

Mechanical Specification: (With Heatsink –xFx-R product options)

Dimensions are in mm [in]. Unless otherwise specified, tolerances are: $x.x \pm 0.5$ [0.02] / $x.xx \pm 0.25$ [0.010]

To avoid damaging components, do not exceed 8.0 [0.32] depth with M3 screws

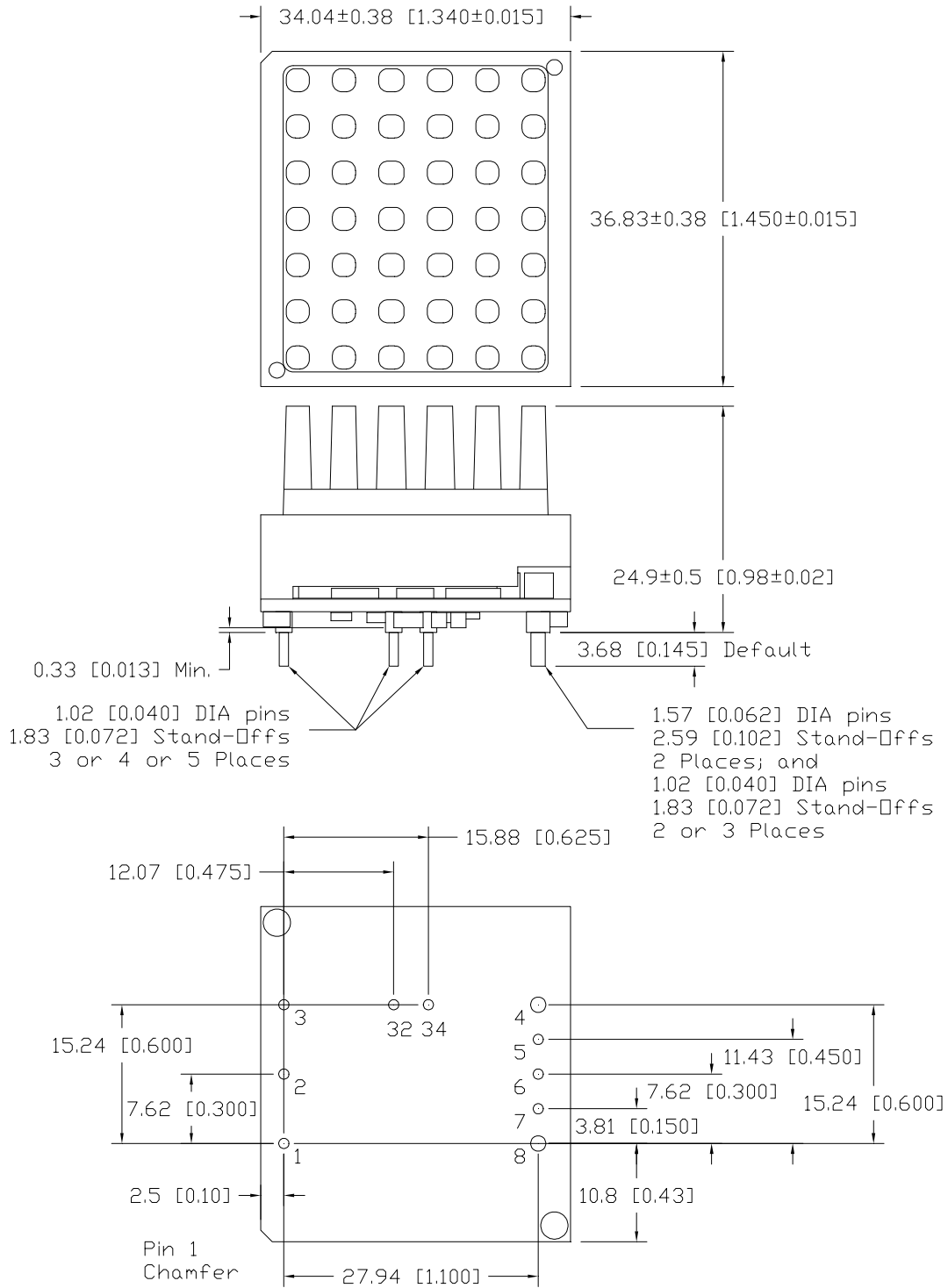

Recommended Hole Pattern – STANDARD –xx1-R: (Top View)

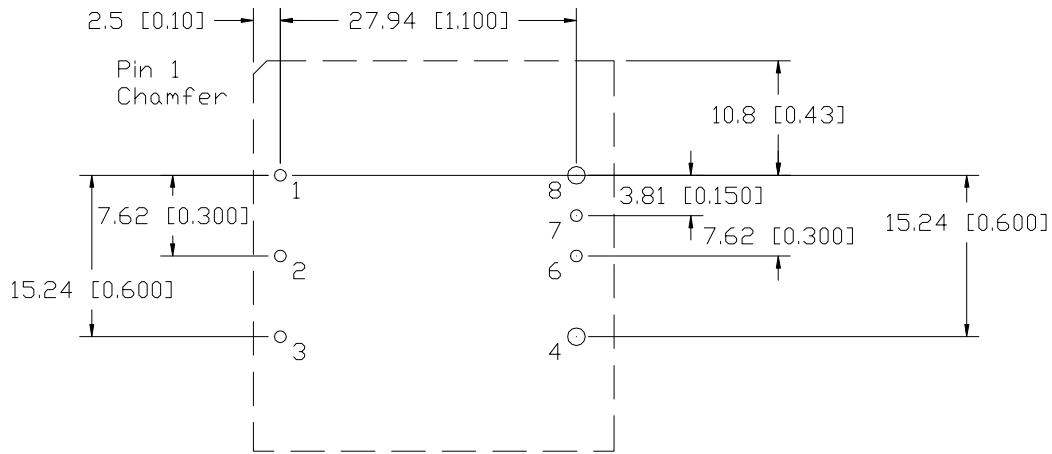

Recommended Hole Pattern – FULL FEATURE –xx2-R / -xx3-R: (Top View)

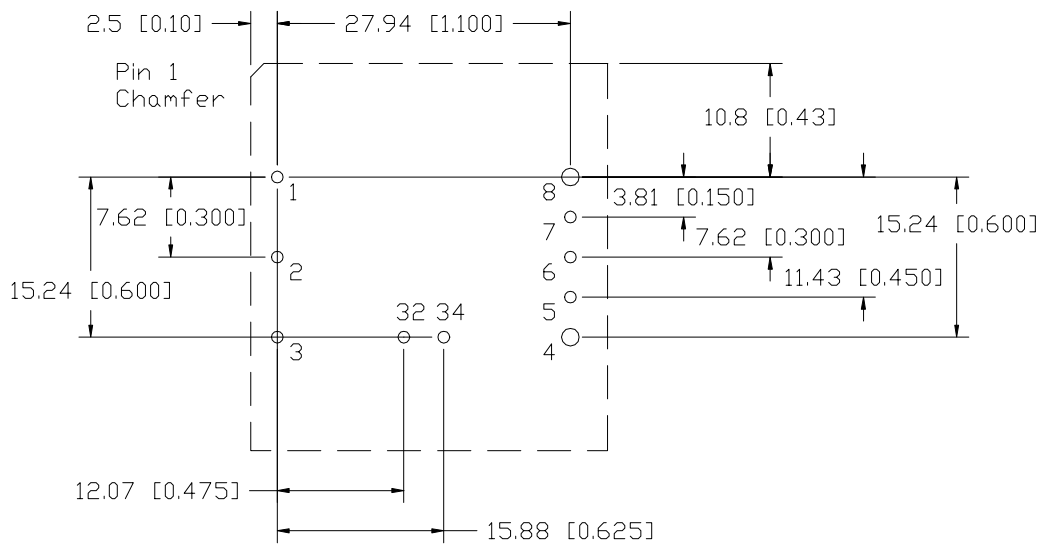

Pin Assignment:

PIN	Function	PIN	Function
1	Vin (+)	6	TRIM
2	On / Off	7	SENSE +
3	Vin (-) / GND	8	Vout (+)
4	Vout (-) / GND	32	Sync (option)
5	Power Good (option)	34	Current Monitor (option)

Note:

Pin base material is brass or copper with gold over nickel plating.

Maximum Weight:

Open Frame (-xxx-R) : 25g (0.88 oz.)

Baseplate (-xCx-R) : 50g (1.76 oz.)

Heatsink (-xFx-R) : 70g (2.47 oz.)

Absolute Maximum Ratings:

Stresses in excess of Absolute Maximum Ratings may cause permanent damage to the device.

Characteristic	Min	Max	Unit	Notes & Conditions
Continuous Input Voltage	-0.25	55	Vdc	
Isolation Voltage	---	---	Vdc	NOT APPLICABALE
Storage Temperature	-55	125	°C	
Operating Temperature Range (Tc)	-40	125*	°C	Measured at the location specified in the thermal measurement figure; maximum temperature varies with output current – see curve in the thermal performance section of the data sheet.

*Engineering estimate

Input Characteristics:

Unless otherwise specified, specifications apply over all rated Input Voltage, Resistive Load and Temperature Conditions.

Characteristic	Min	Typ	Max	Unit	Notes & Conditions
Operating Input Voltage	10	---	53	Vdc	
Maximum Input Current	---	---	25	A	Vin = Vin,min to Vin,max; Io = Io,max
Stand-by Input current	---	0.25	---	mA	Vin = Vin,nom, On/Off = Off
No load Input current	---	5.0	---	mA	Vin = 24V; Vo = 12V; Io = No load
Startup Delay Time from application of input voltage	---	5	---	ms	Vo = 0 to 0.1*Vo,set; On/Off = On, Io = Io,max, Tc = 25°C
Startup Delay Time from On/Off	---	5	---	ms	Vo = 0 to 0.1*Vo,set; Vin = Vi,nom, Io = Io,max, Tc = 25°C
Output Voltage Rise Time	---	15	---	ms	Io = Io,max, Tc = 25°C, Vo = 0.1 to 0.9*Vo,set
Input Ripple Rejection	---	50*	---	dB	@ 120 Hz
Turn on input voltage	---	9.5	---	V	
Turn off input voltage	---	8.5	9	V	
Output / Input conversion ratio "Vo / Vin"	0.125			---	

*Engineering estimate

Caution: The power modules are not internally fused. An external input line normal blow fuse with a maximum value of 30A is required; see the Safety Considerations section of the data sheet.

Operating Range:

Allowable output current is limited by combination of V_{in} and V_{out} during Step-up mode. Output voltage may start to decrease if allowable output current is exceeded.

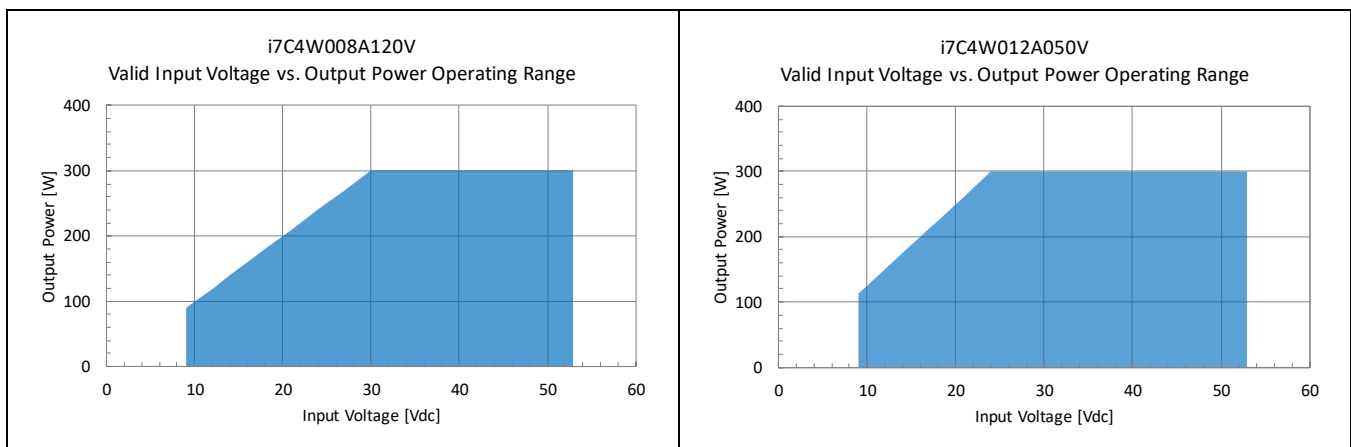
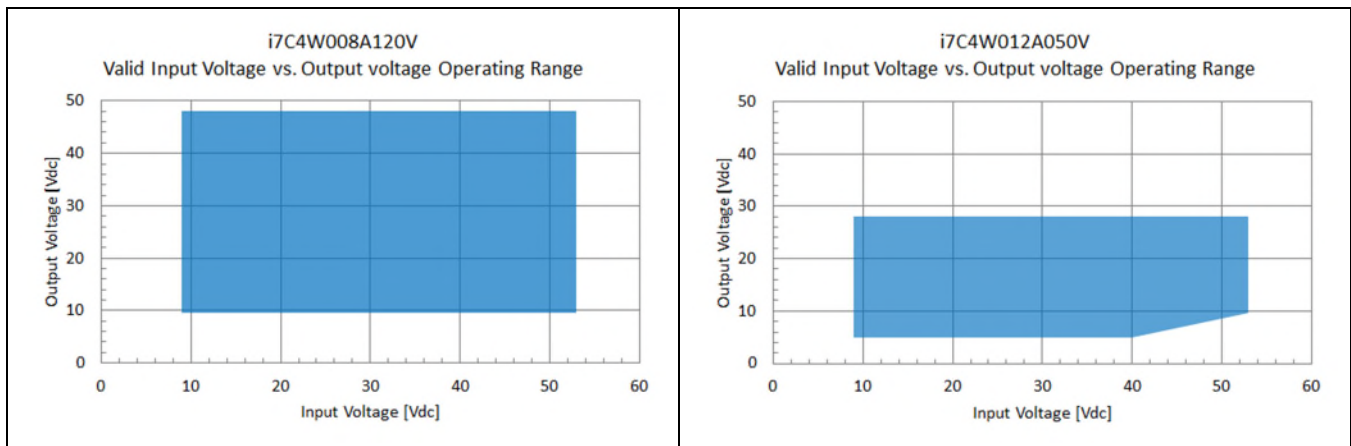
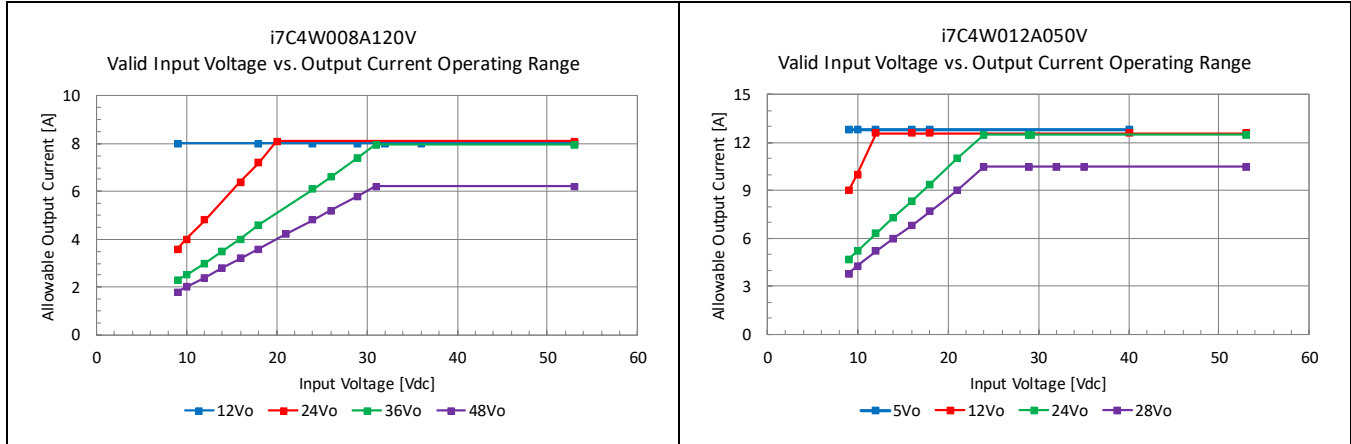

Electrical Characteristics:

i7C4W012A050V-xxx-R (12.5A)

Characteristic	Min	Typ	Max	Unit	Notes & Conditions
Output Voltage Initial Set point	-2.5	-	+2.5	%	Vin=Vin,nom; Io=Io,min; Tc = 25°C
Output Voltage Tolerance	-4.0	-	+4.0	%	Over all rated input voltage, load, and temperature conditions to end of life
Efficiency	Vo = 12V	---	91	---	Vin=10V; Io=Io,max; Tc = 25°C
	Vo = 24V	---	94	---	
Efficiency	Vo = 12V	---	94	---	Vin=24V; Io=Io,max; Tc = 25°C
	Vo = 24V	---	96	---	
Efficiency	Vo = 12V	---	93	---	Vin=48V; Io=Io,max; Tc = 25°C
	Vo = 24V	---	96	---	
Line Regulation	---	0.8	---	%	Vin=Vin,min to Vin,max
Load Regulation	---	0.8	---	%	Io=Io,min to Io,max
Output Current	0	---	12.5	A	Observe maximum power limit. Allowable output current varies with input voltage, please refer to chart.
Output Current Limiting Threshold	---	17	---	A	Vo = 0.9*Vonom, Tc<Tc,max
Short Circuit Current	---	3.5	---	A	Vo = 0.25V, Tc = 25°C
Over Temperature Protection Threshold	---	130	--	°C	Referenced hot spot
Output Ripple and Noise Voltage	Step down : 53Vin, 24Vo, 12.5A	---	100	---	Measured across one 330 µF electrolytic capacitor and one 22 µF ceramic capacitor – see input/output ripple measurement figure; BW = 20MHz.
	Step up : 10Vin, 24Vo, 5.5A	---	350	---	
Output Voltage Adjustment Range	5	---	28	V	
Output Voltage Sense Range	---	---	5	%	
Dynamic Response: Recovery Time	---	200	---	µs	di/dt = 1A/us, Vin=Vin,nom; Vo=24V, load step from 25% to 75% of Io,max
Transient Voltage	---	500	---	mV	
Switching Frequency	---	250	---	kHz	Fixed, at light loads the module may skip pulses
External Load Capacitance	330	---	3000*	µF	
Vref	---	1.0	---	V	Required for trim calculation
Vo,nom	---	5.013	---	V	Required for trim calculation
F	---	30100	---	Ω	Required for trim calculation
G	---	1000	---	Ω	Required for trim calculation

* Due to the extremely wide range of input and output conditions, I7C performance such as output ripple and transient voltage behavior can vary significantly from application to application. Please confirm performance in actual use case. TDK-Lambda can assist with selection of external components. Please contact technical support, especially if very low ESR capacitor banks beyond the listed range are required.

Typical Efficiency vs. Input Voltage:

i7C4W012A050V-xxx-R (12.5A)

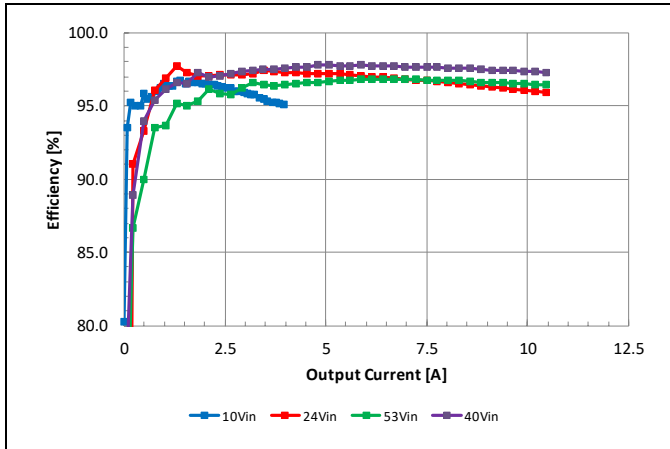

Vo = 28V

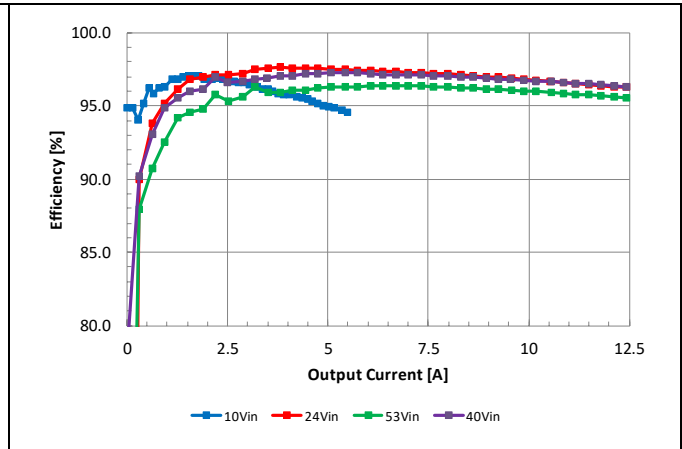

Vo = 24V

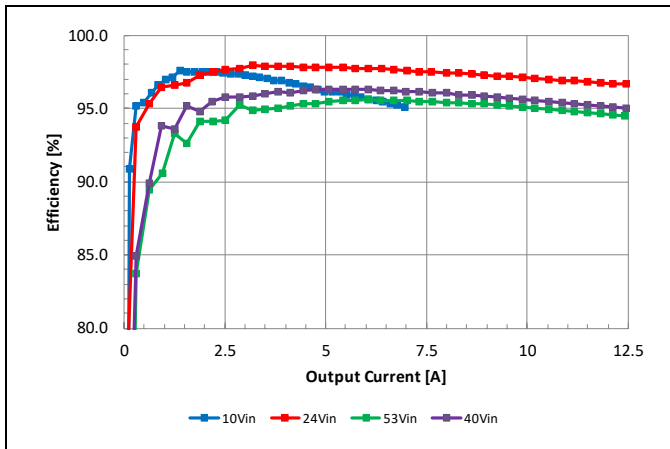

Vo = 18V

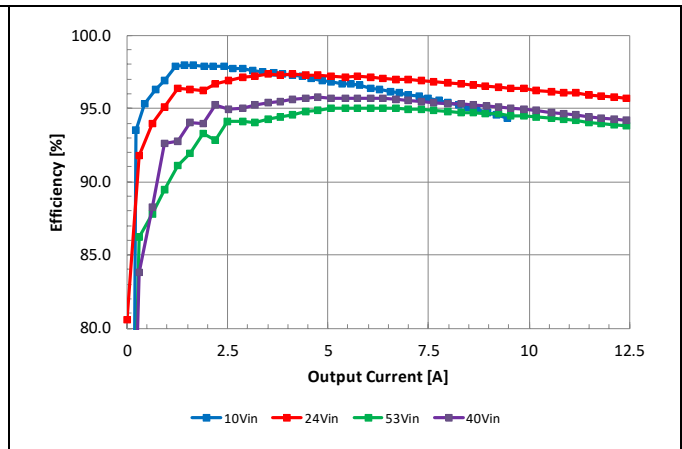

Vo = 15V

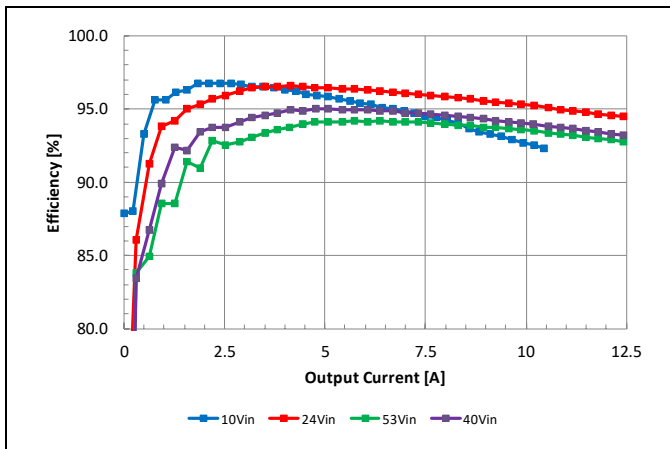

Vo = 12V

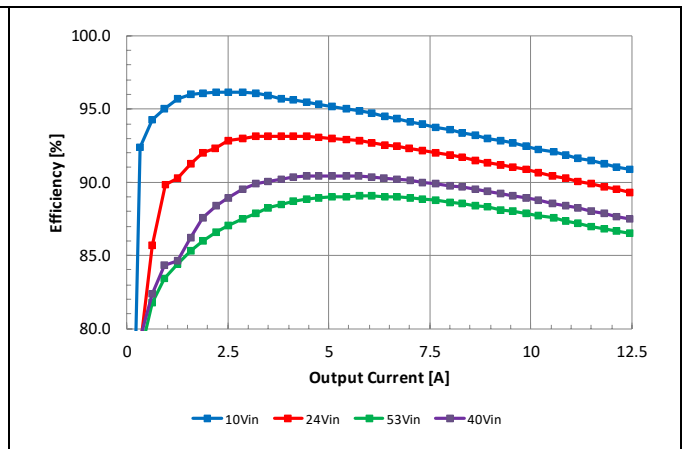

Vo = 5V

Typical Power Dissipation vs. Input Voltage:

i7C4W012A050V-xxx-R (12.5A)

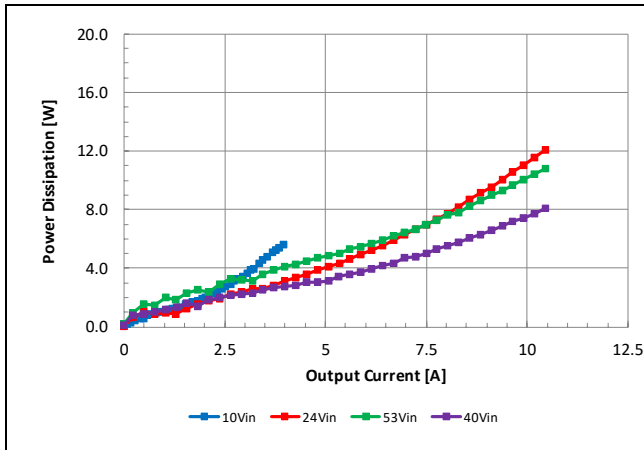

$V_o = 28V$

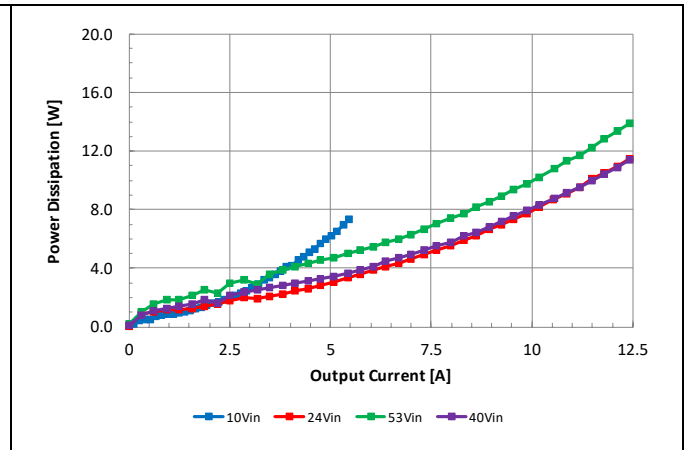

$V_o = 24V$

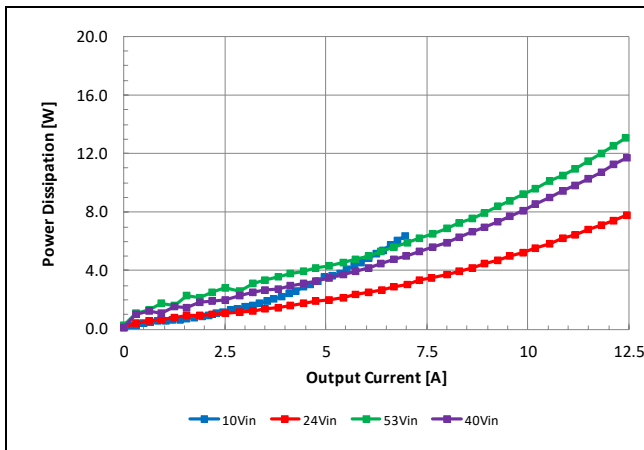

$V_o = 18V$

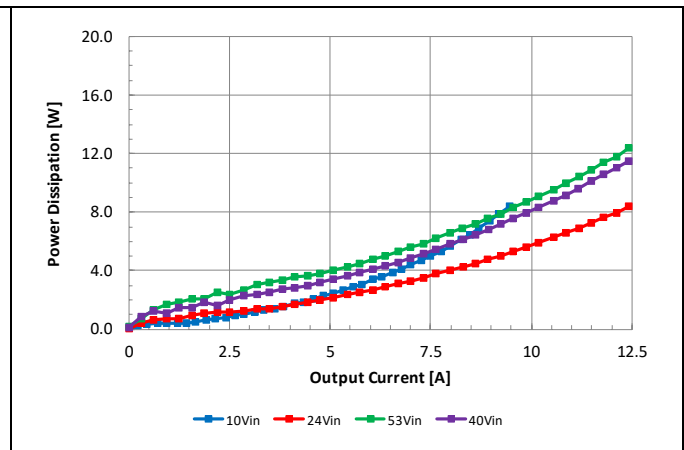

$V_o = 15V$

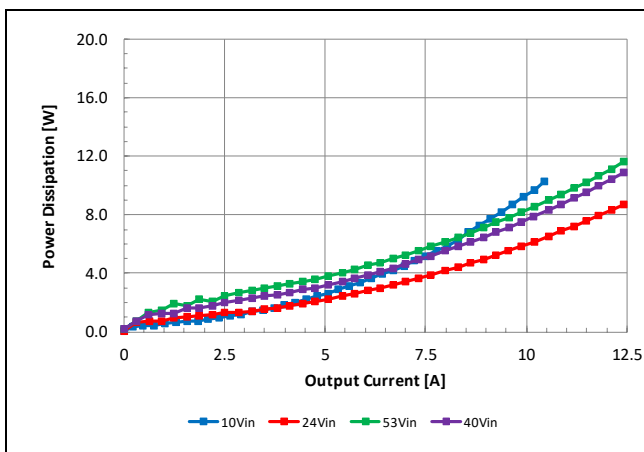

$V_o = 12V$

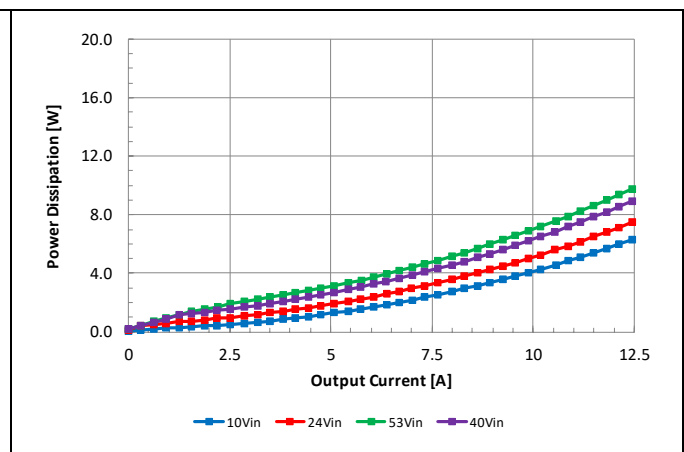

$V_o = 5V$

Static Characteristic:

i7C4W012A050V-xxx-R (Vo = 12V)

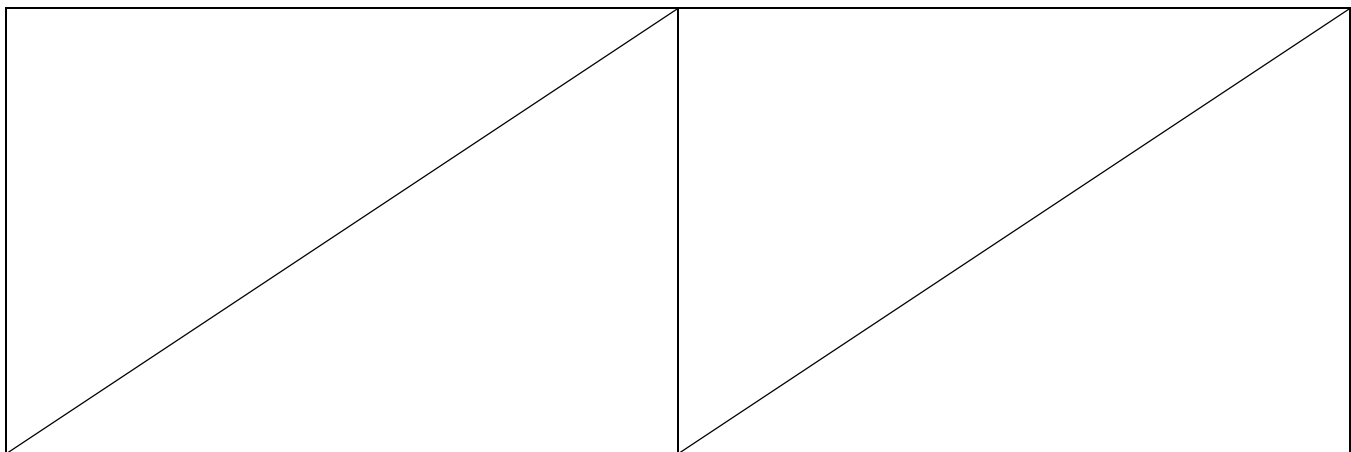
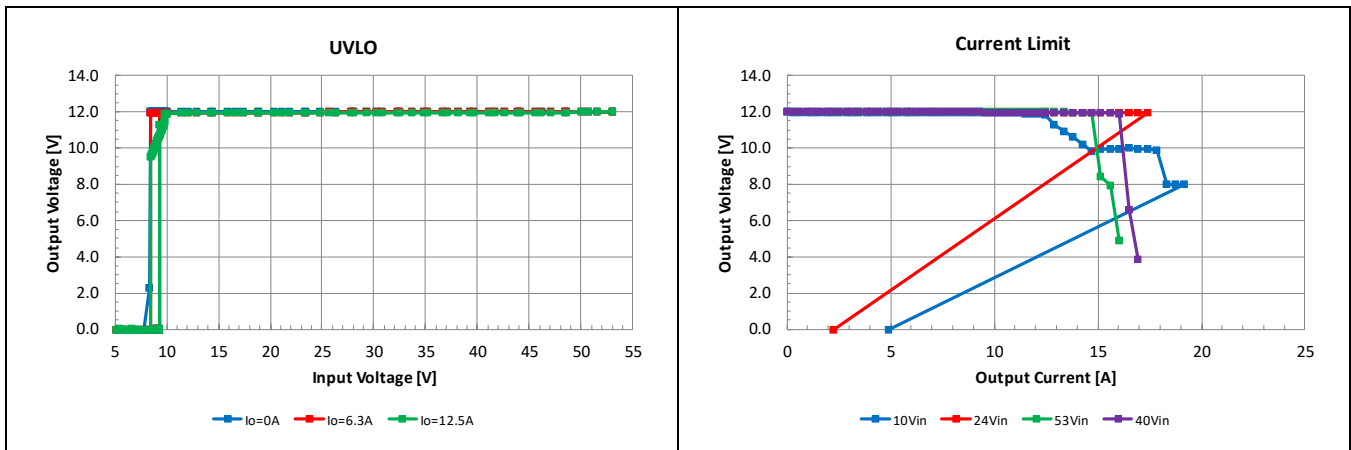
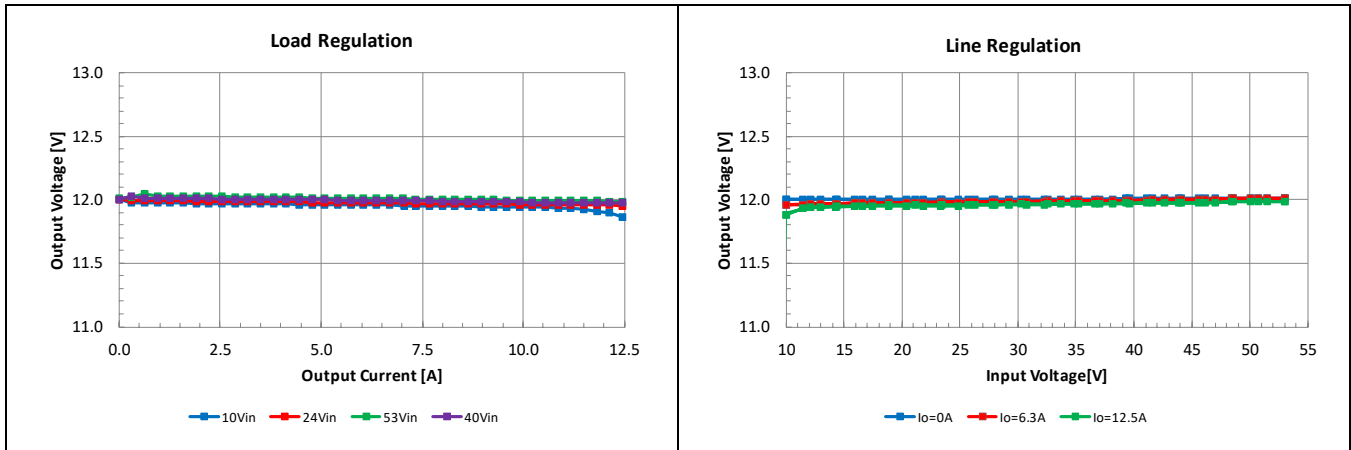

Typical Waveform:

i7C4W012A050V-xxx-R (Vo = 12V)

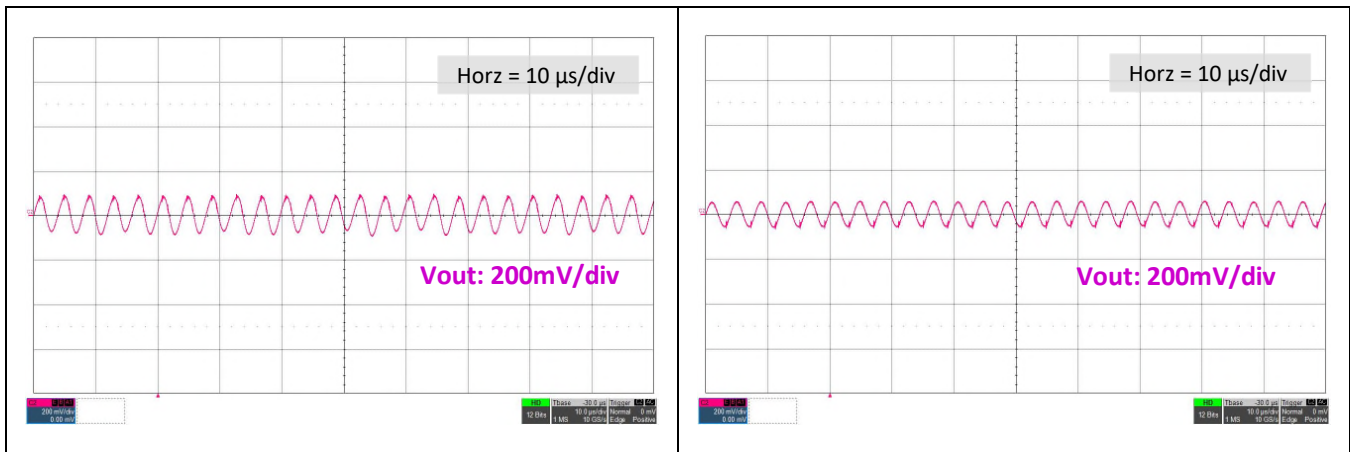

Typical Output Ripple at full load with step-up mode; Vin=10V, Vo=12V, Io=12.5A; Cext=330μF with 60mohm ESR of electrolytic capacitor.

Typical Output Ripple at full load with step-down mode; Vin=24V, Vo=12V, Io=12.5A; Cext=330μF with 60mohm ESR of electrolytic capacitor.

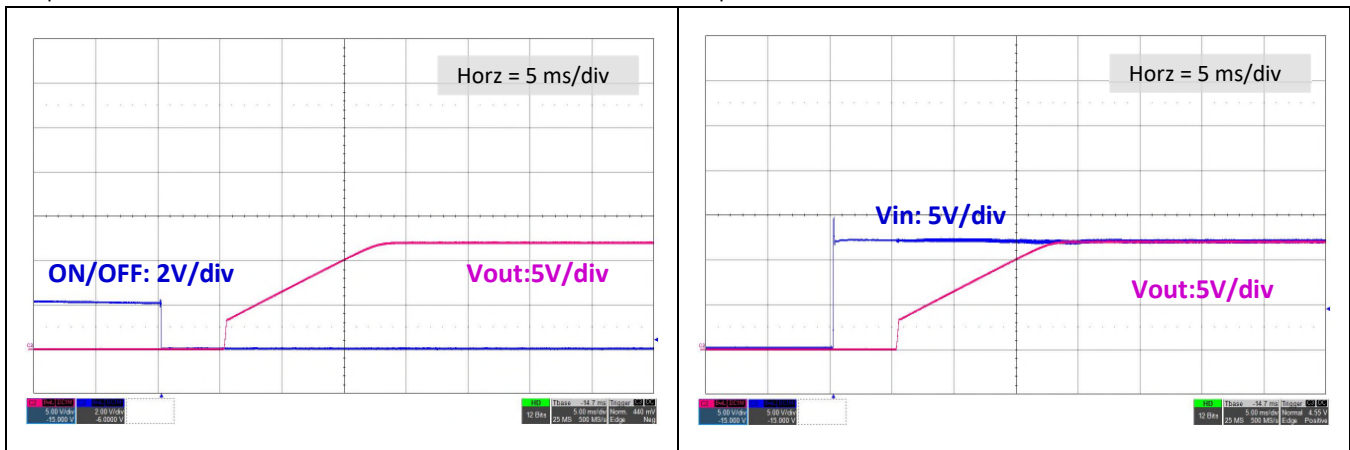

Typical startup characteristic from On/Off at full load; Vin=12V, Vo=12V, Io=12.5A, Cext=330μF.

Typical startup characteristic from Vin at full load; Vin=12V, Vo=12V, Io=12.5A, Cext=330μF.

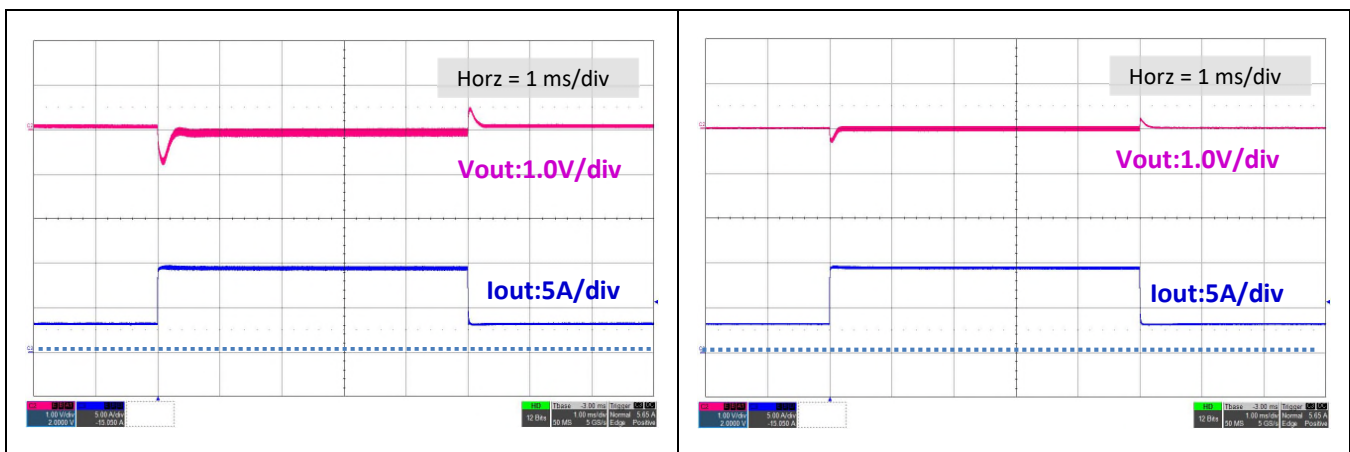

Typical Load transient response with step-up mode; Load Step from/to 25%(3A) and 75%(9A) with Slew rate of 1.0A/μs; Vin=10V, Vo=12V Cext = 330μF.

Typical Load transient response with step-down mode; Load Step from/to 25%(3A) and 75%(9A) with Slew rate of 1.0A/μs Vin=24V, Vo=12V Cext = 330μF

Static Characteristic:

i7C4W012A050V-xxx-R (Vo = 24V)

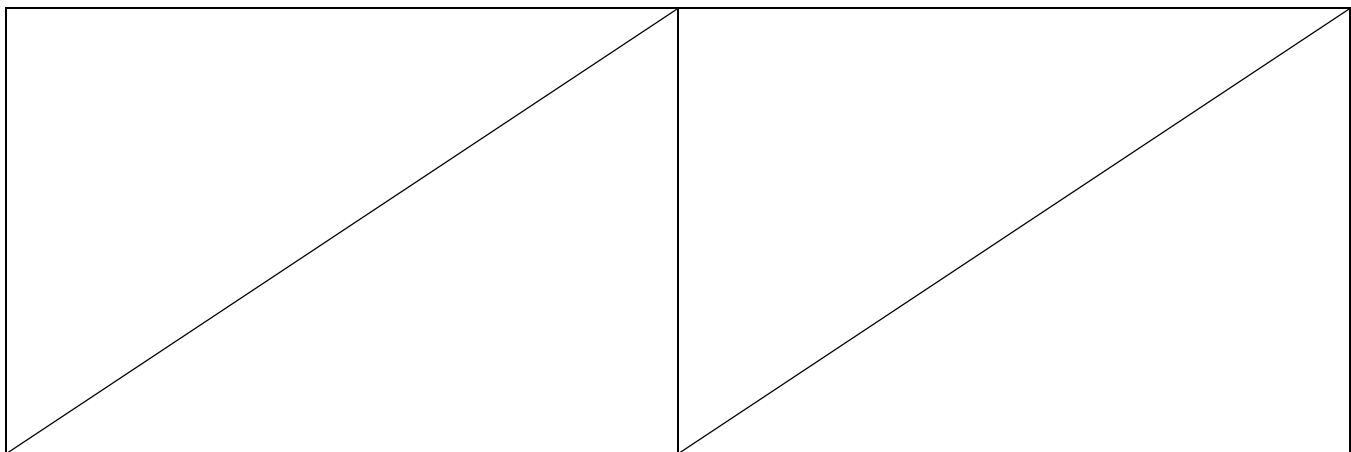
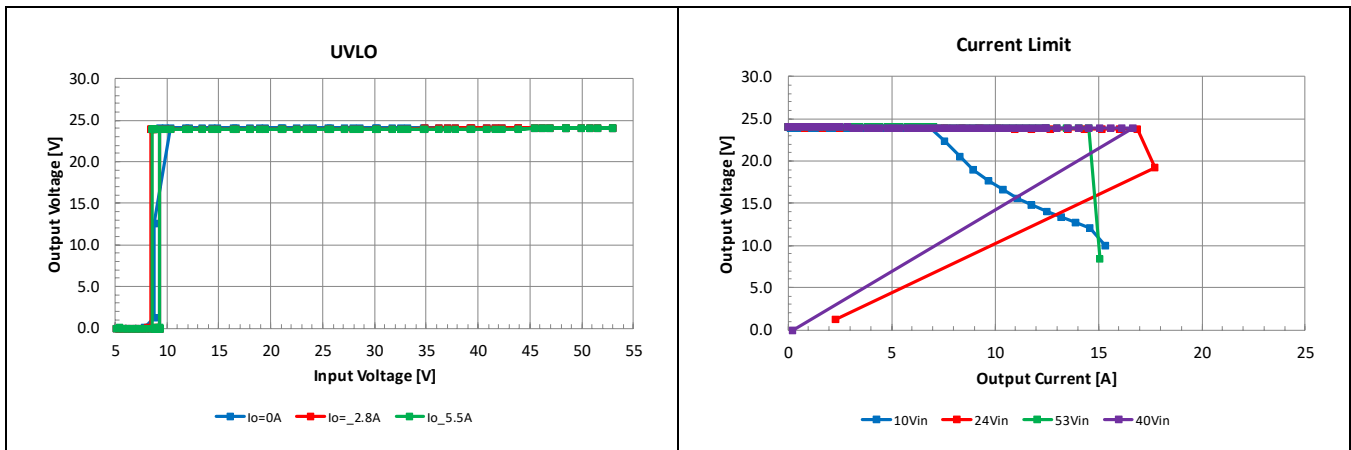
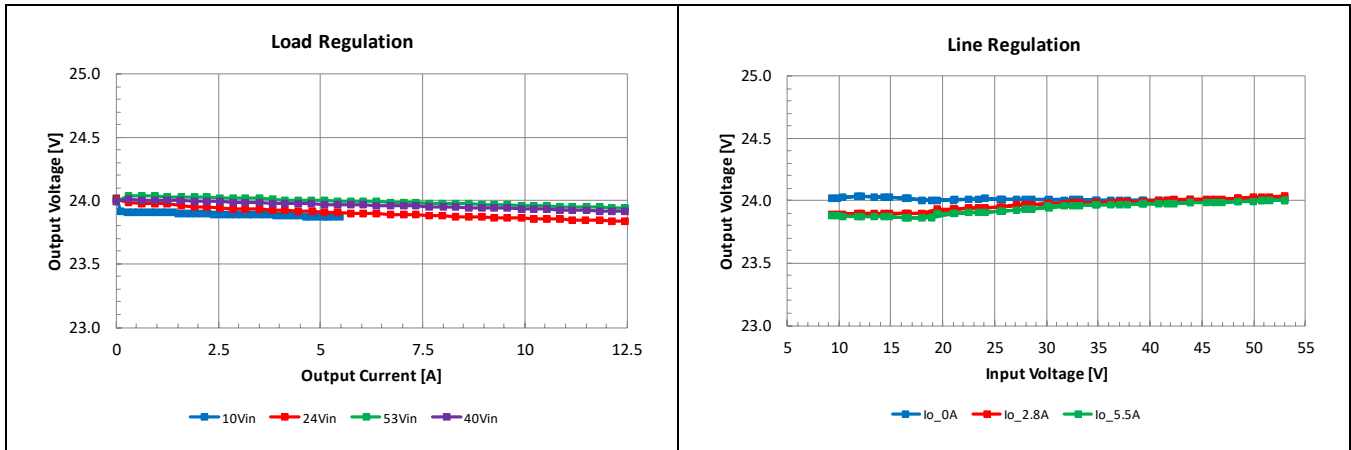

Typical Waveform:

i7C4W012A050V-xxx-R (Vo = 24V)

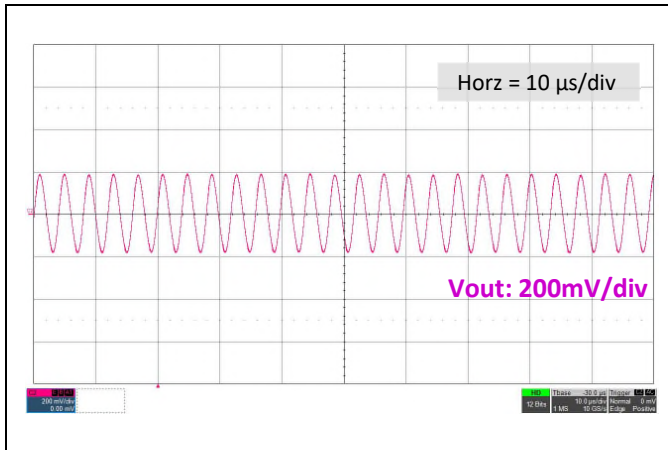

Typical Output Ripple at full load with step-up mode; Vin=10V, Vo=24V, Io=5.5A; Cext=330 μ F with 60mohm ESR of electrolytic capacitor.

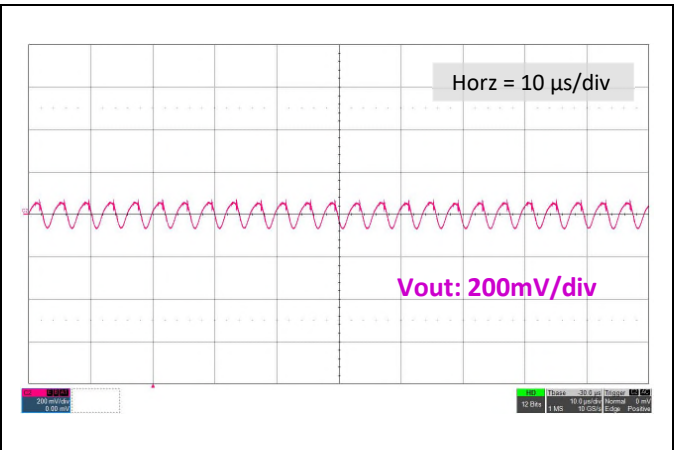

Typical Output Ripple at full load with step-down mode; Vin=24V, Vo=24V, Io=12.5A, Cext=330 μ F; with 60mohm ESR of electrolytic capacitor.

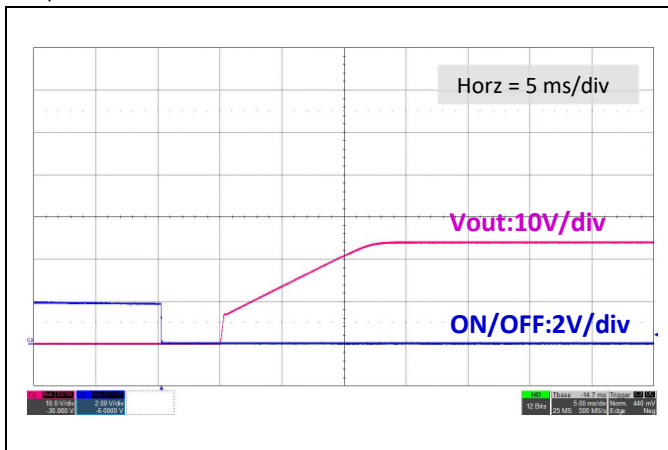

Typical startup characteristic from On/Off at full load; Vin=24V, Vo=24V, Io=12.5A, Cext=330 μ F.

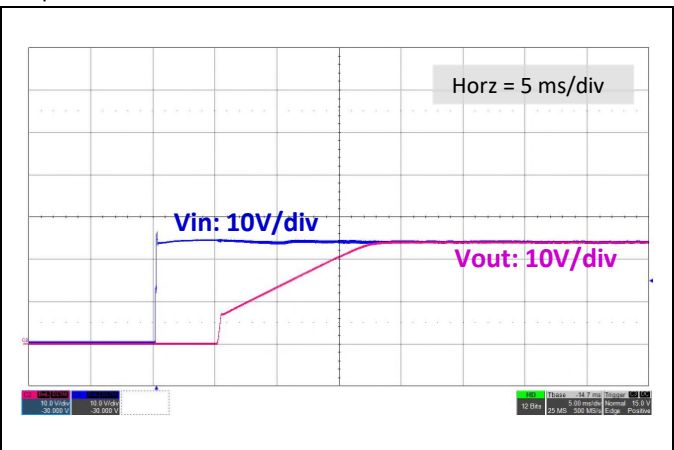

Typical startup characteristic from Vin at full load; Vin=24V, Vo=24V, Io=12.5A, Cext=330 μ F.

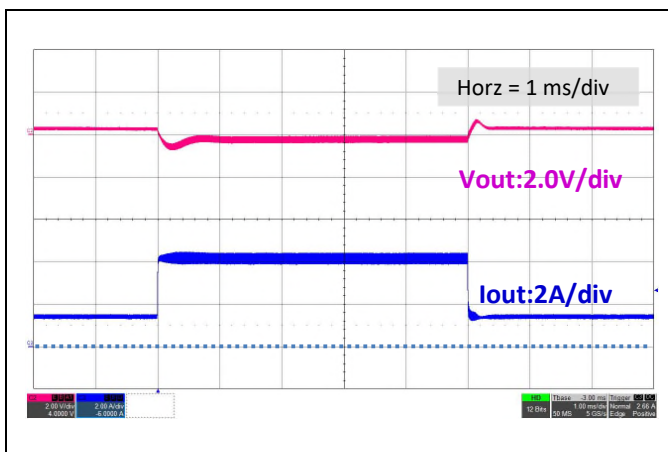

Typical Load transient response with step-up mode; Load Step from/to 25%(1.8A) and 75%(4.2A) with Slew rate of 1.0A/ μ s; Vin=10V, Vo=24V Cext = 330 μ F.

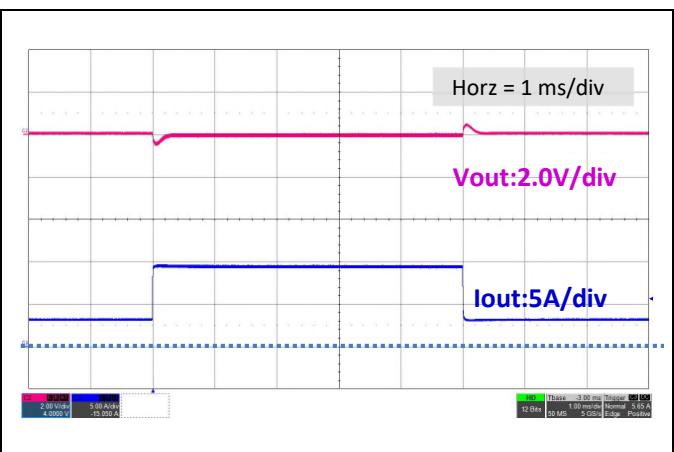

Typical Load transient response with step-down mode; Load Step from/to 25%(3A) and 75%(9A) with Slew rate of 1.0A/ μ s; Vin=24V, Vo=24V Cext = 330 μ F.

Thermal Performance: i7C4W012A050V (Open frame –00x-R)

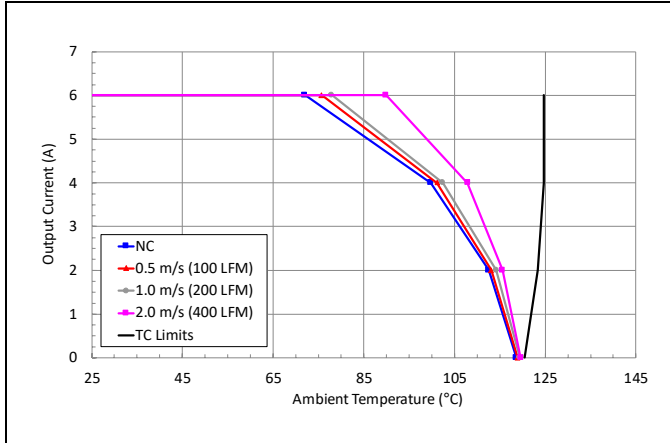

Vin=12V, Vo=24V preliminary maximum output current vs. ambient temperature for natural convection (60lfm) to 2m/s (400 lfm) with airflow from pin 3 to pin 4.

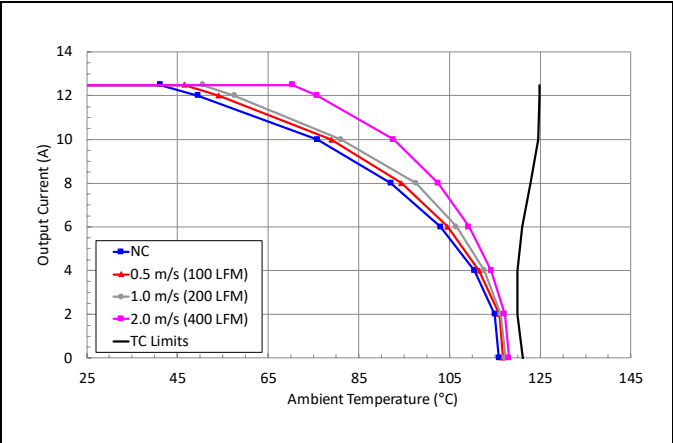

Vin=12V, Vo=12V preliminary maximum output current vs. ambient temperature for natural convection (60lfm) to 2m/s (400 lfm) with airflow from pin 3 to pin 4.

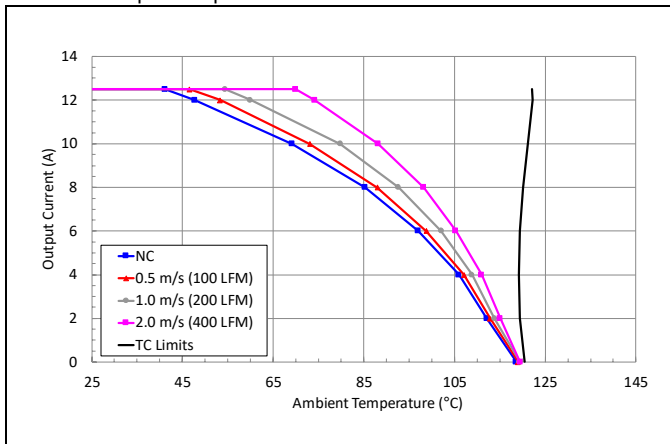

Vin=24V, Vo=24V preliminary maximum output current vs. ambient temperature for natural convection (60lfm) to 2m/s (400 lfm) with airflow from pin 3 to pin 4.

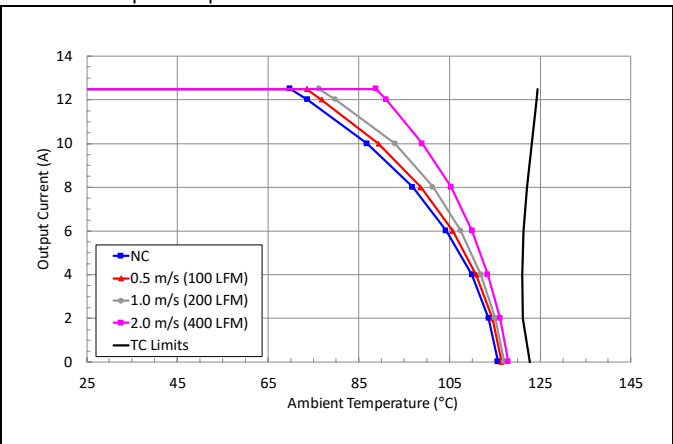

Vin=24V, Vo=12V preliminary maximum output current vs. ambient temperature for natural convection (60lfm) to 2m/s (400 lfm) with airflow from pin 3 to pin 4.

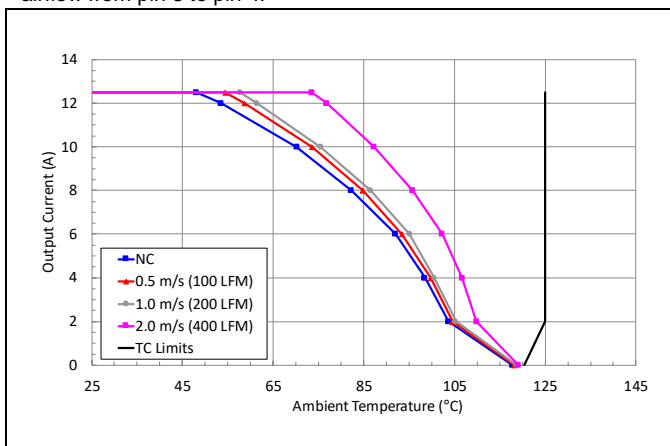

Vin=48V, Vo=24V preliminary maximum output current vs. ambient temperature for natural convection (60lfm) to 2m/s (400 lfm) with airflow from pin 3 to pin 4.

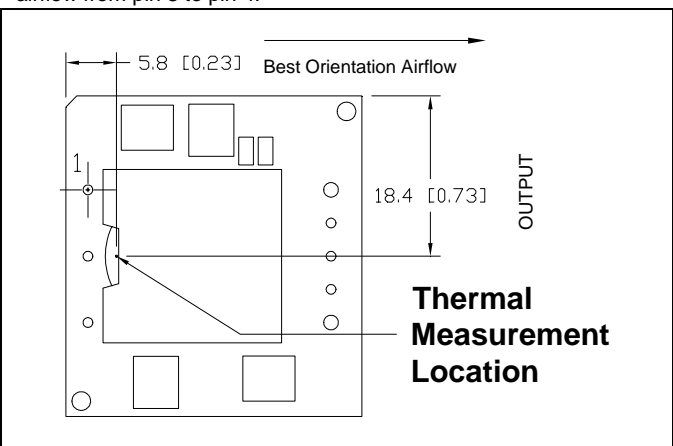

The thermal curves provided are based on measurements made in TDK Lambda's test setup that is described in the Thermal Management section. Due to the large number of variables in system design and the extremely wide operating range of the module, TDK Lambda recommends that the user verify the module's thermal performance in the end application. The critical component should be thermocoupled, monitored and should not exceed the temperature limit specified in the derating curve above. It is critical that the thermocouple be mounted in a manner that gives direct thermal contact or significant measurement errors may result. TDK Lambda can provide modules with a thermocouple pre-mounted to the critical component for system verification tests.

Thermal Performance: i7C4W012A050V (With Heat sink -0Fx-R)

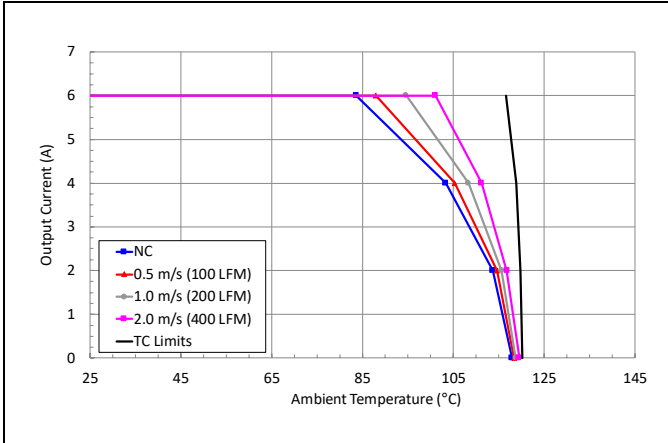

Vin=12V, Vo=24V preliminary maximum output current vs. ambient temperature for natural convection (60lfm) to 2m/s (400 lfm) with airflow from pin 3 to pin 4.

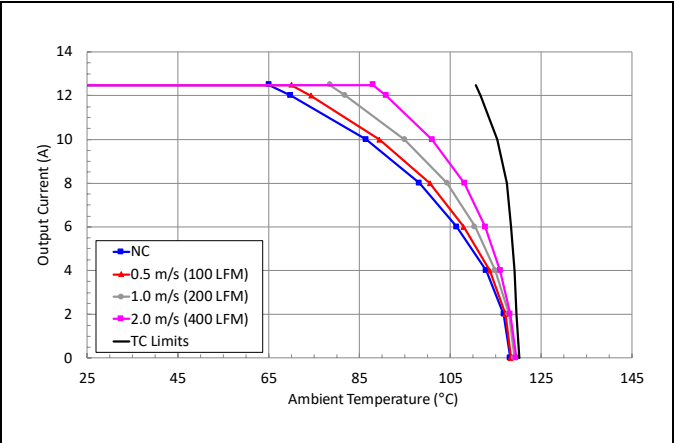

Vin=12V, Vo=12V preliminary maximum output current vs. ambient temperature for natural convection (60lfm) to 2m/s (400 lfm) with airflow from pin 3 to pin 4.

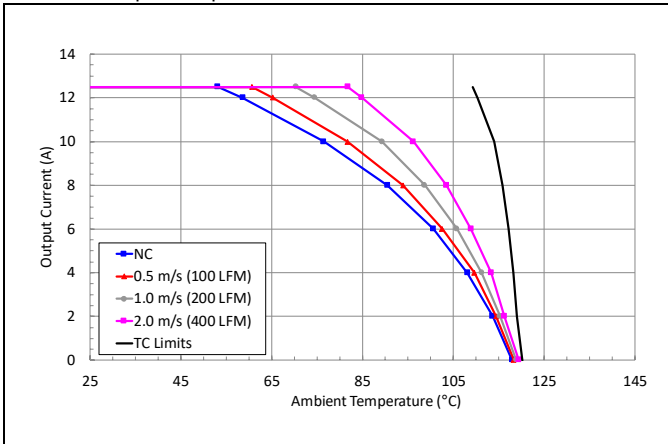

Vin=24V, Vo=24V preliminary maximum output current vs. ambient temperature for natural convection (60lfm) to 2m/s (400 lfm) with airflow from pin 3 to pin 4.

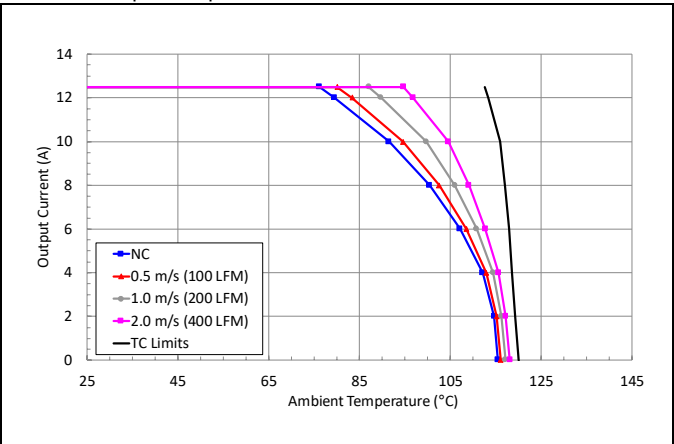

Vin=24V, Vo=12V preliminary maximum output current vs. ambient temperature for natural convection (60lfm) to 2m/s (400 lfm) with airflow from pin 3 to pin 4.

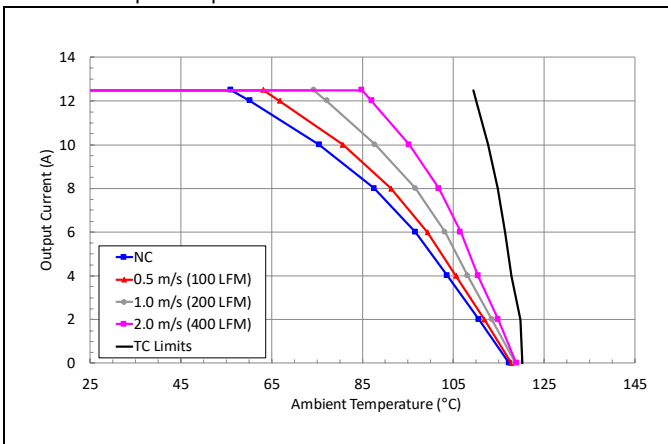

Vin=48V, Vo=24V preliminary maximum output current vs. ambient temperature for natural convection (60lfm) to 2m/s (400 lfm) with airflow from pin 3 to pin 4.

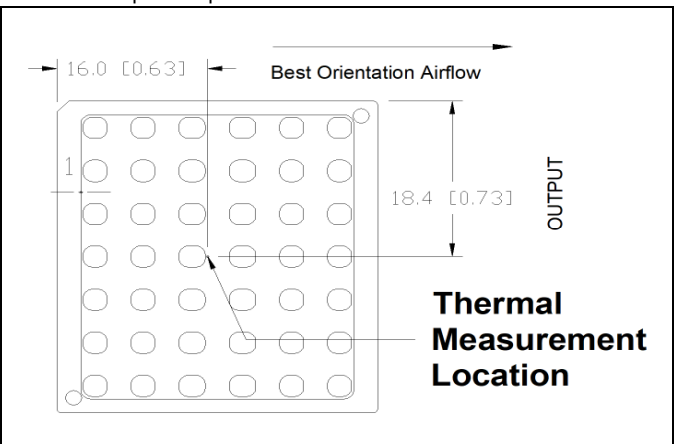

Thermal Performance: i7C4W012A050V (With base plate –0Cx-R)

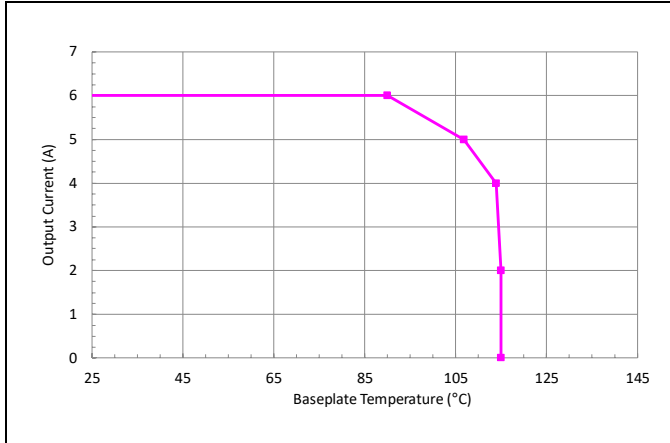

Vin=12V, Vo=24V preliminary maximum output current vs. baseplate temperature with enclosed environment.

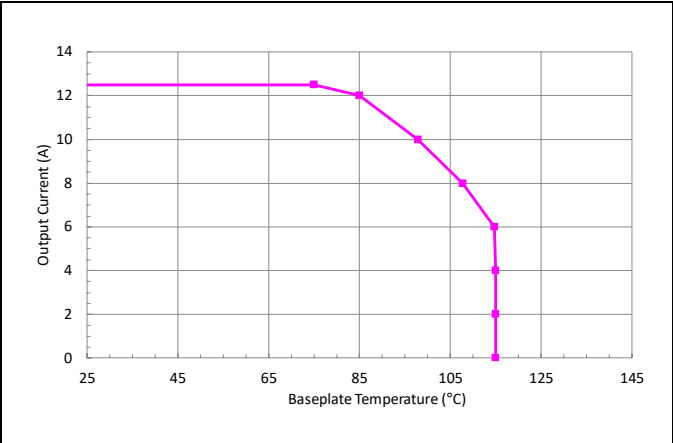

Vin=12V, Vo=12V preliminary maximum output current vs. baseplate temperature with enclosed environment.

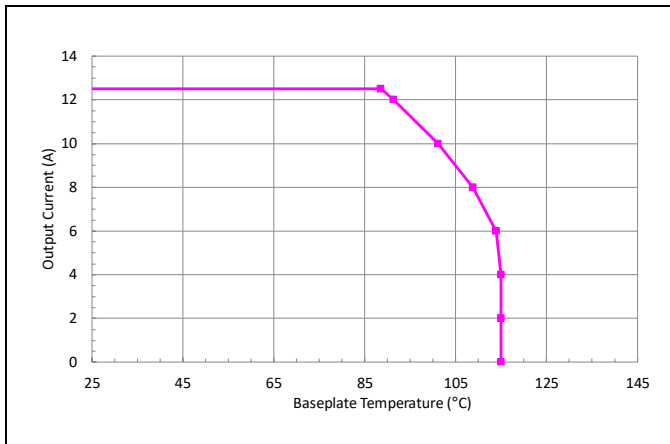

Vin=24V, Vo=24V preliminary maximum output current vs. baseplate temperature with enclosed environment.

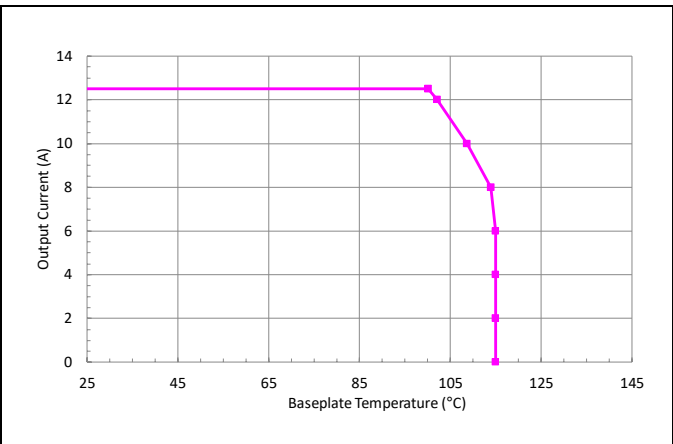

Vin=24V, Vo=12V preliminary maximum output current vs. baseplate temperature with enclosed environment.

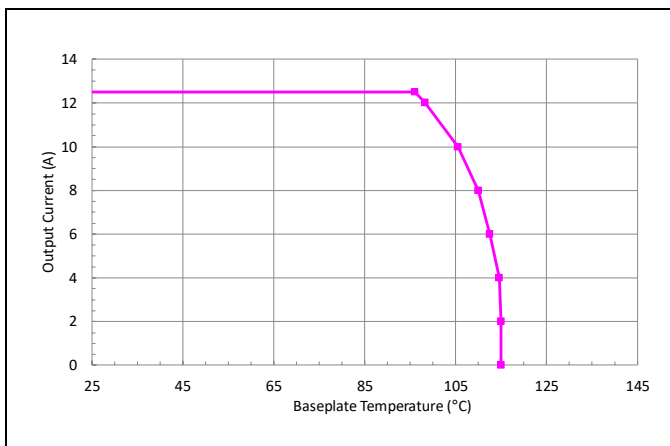

Vin=48V, Vo=24V preliminary maximum output current vs. baseplate temperature with enclosed environment.

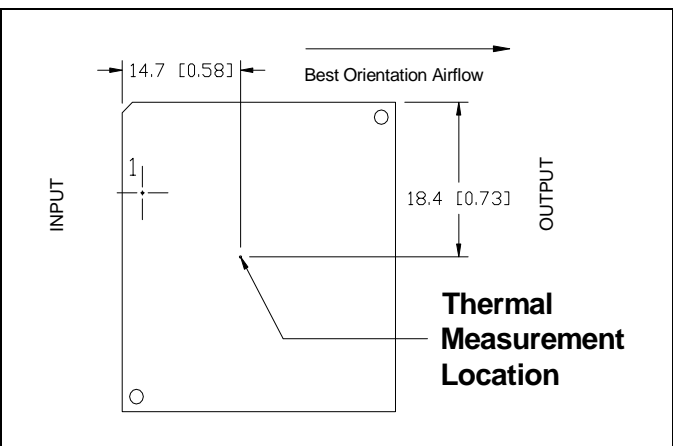

Electrical Characteristics:

i7C4W008A120V-xxx-R (8A)

Characteristic	Min	Typ	Max	Unit	Notes & Conditions
Output Voltage Initial Set point	-2.5	-	+2.5	%	Vin=Vin,nom; Io=Io,min; Tc = 25°C
Output Voltage Tolerance	-4	-	+4	%	Over all rated input voltage, load, and temperature conditions to end of life
Efficiency	Vo = 12V	---	95	%	Vin=10V; Io=Io,max; Tc=25°C
	Vo = 24V	---	95	%	
Efficiency	Vo = 12V	---	95	%	Vin=24V; Io=Io,max; Tc=25°C
	Vo = 24V	---	97	%	
Efficiency	Vo = 12V	---	93	%	Vin=48V; Io=Io,max; Tc=25°C
	Vo = 24V	---	96	%	
Line Regulation	---	0.8	---	%	Vin=Vin,min to Vin,max
Load Regulation	---	0.5	---	%	Io=Io,min to Io,max
Output Current	0	---	8	A	Observe maximum power limit. Allowable output current varies with input voltage, please refer to chart
Output Current Limiting Threshold	---	15	---	A	Vo = 0.9*Vonom, Tc<Tc,max
Short Circuit Current	---	2.5	---	A	Vo = 0.25V, Tc = 25°C
Over Temperature Protection Threshold	---	130	--	°C	Referenced hot spot
Output Ripple and Noise Voltage	Step down : 53Vin, 24Vo, 8A	---	60	---	Measured across one 330 μF electrolytic capacitor and one 22μF ceramic capacitor – see input/output ripple measurement figure; BW = 20MHz.
	Step up : 10Vin, 24Vo, 4A	---	300	---	
Output Voltage Adjustment Range	9.6	---	48	V	
Output Voltage Sense Range	---	---	5	%	
Dynamic Response: Recovery Time	---	300	---	μS	di/dt = 1A/μS, Vin=Vin,nom; Vo=12V, load step from 25% to 75% of Io,max
Transient Voltage	---	400	---	mV	
Switching Frequency	---	250	---	kHz	Fixed, at light loads the module may skip pulses
External Load Capacitance	330	---	3000*	μF	
Vref	---	1.0	---	V	Required for trim calculation
Vonom	---	9.35	---	V	Required for trim calculation
F	---	30100	---	Ω	Required for trim calculation
G	---	750	---	Ω	Required for trim calculation

* Due to the extremely wide range of input and output conditions, I7C performance such as output ripple and transient voltage behavior can vary significantly from application to application. Please confirm performance in actual use case. TDK-Lambda can assist with selection of external components. Please contact technical support, especially if very low ESR capacitor banks beyond the listed range are required.

Typical Efficiency vs. Input Voltage:

i7C4W008A120V-xxx-R (8A)

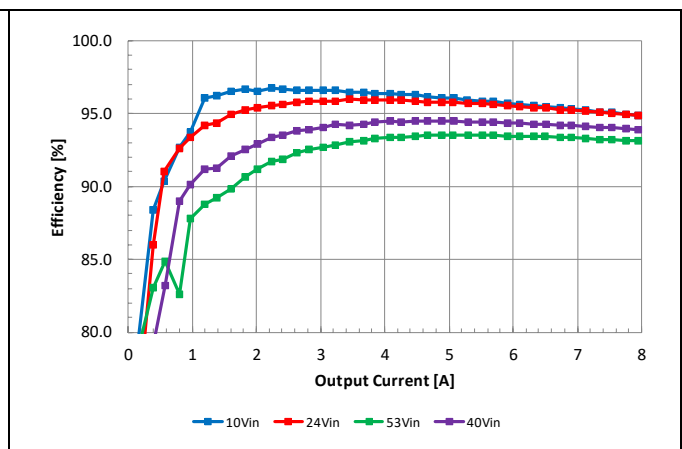
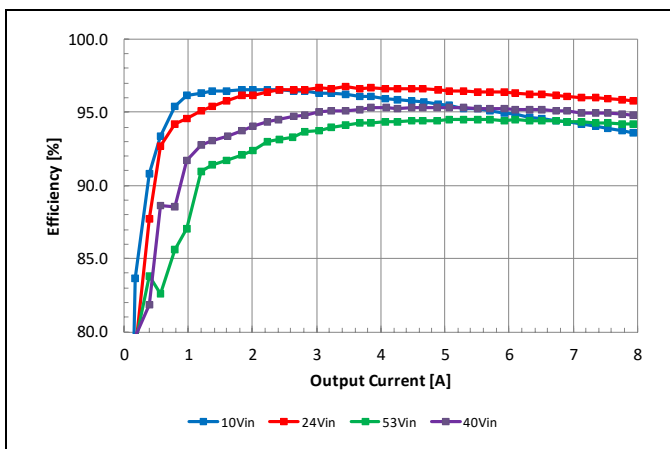
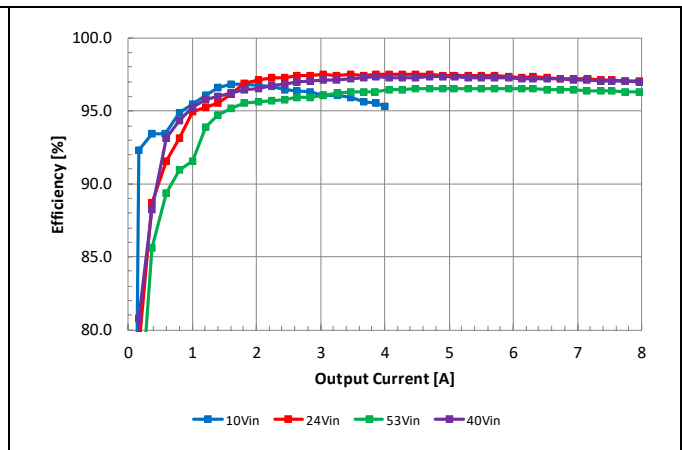
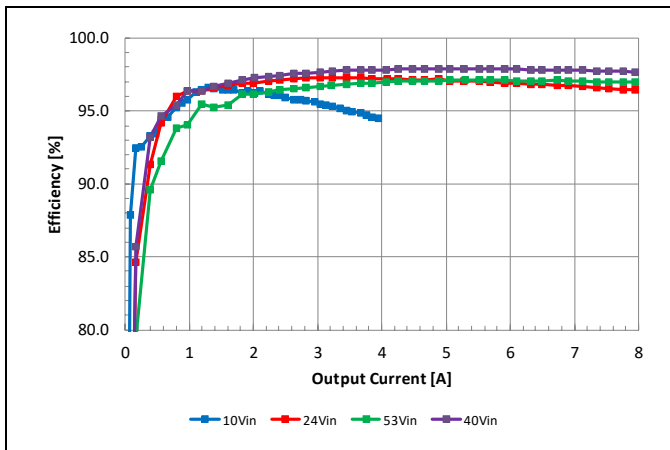
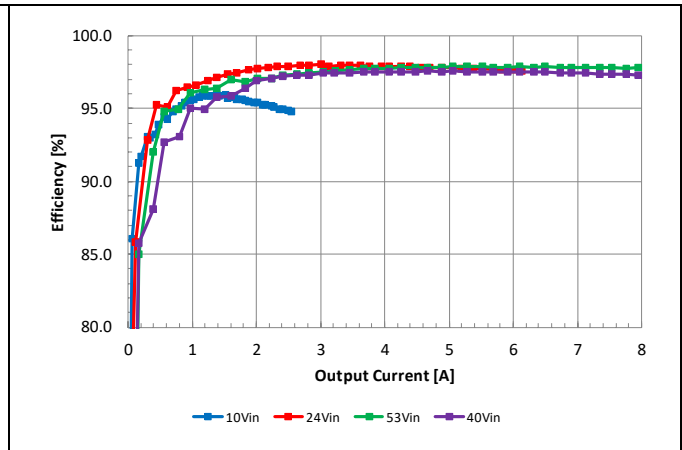
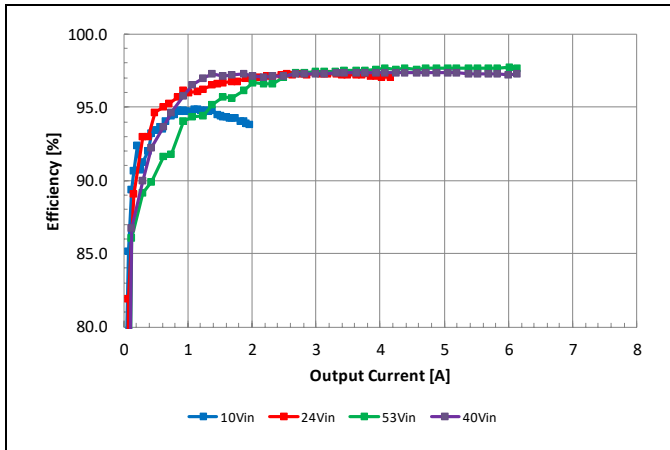

Typical Power Dissipation vs. Input Voltage:

i7C4W008A120V-xxx-R (8A)

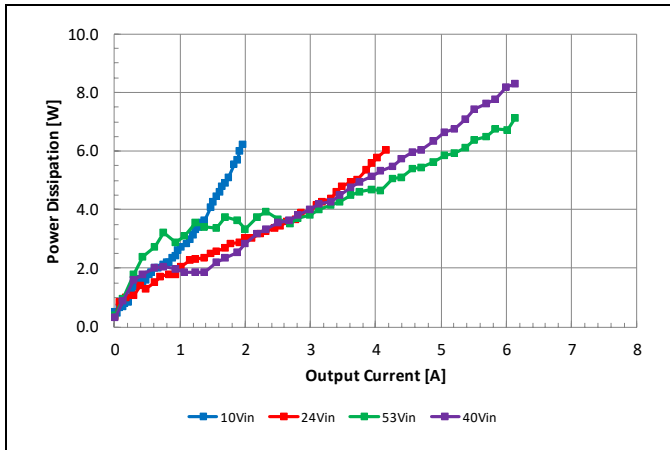

Vo = 48V

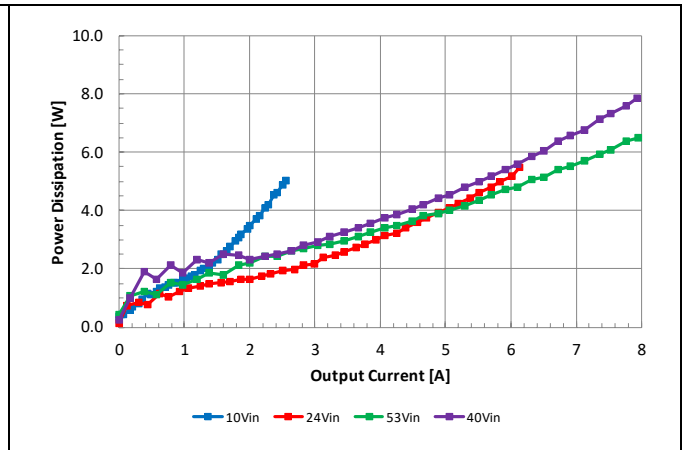

Vo = 36V

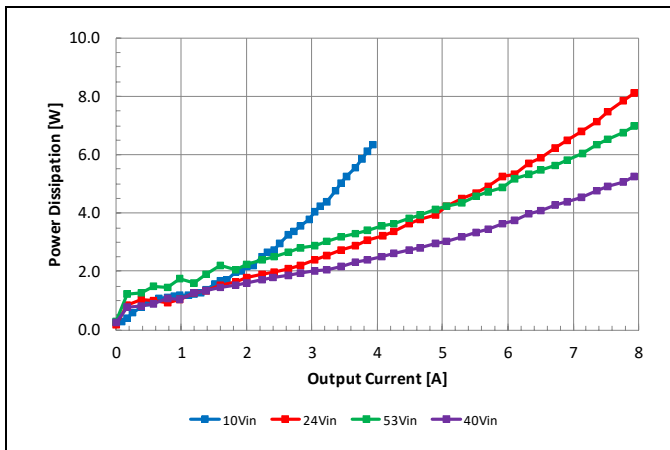

Vo = 28V

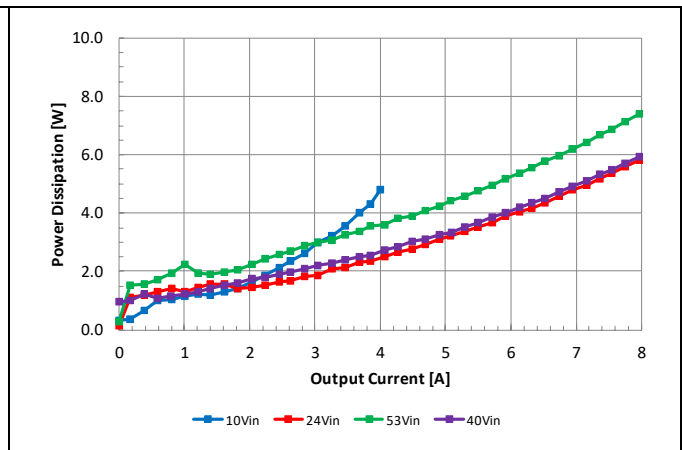

Vo = 24V

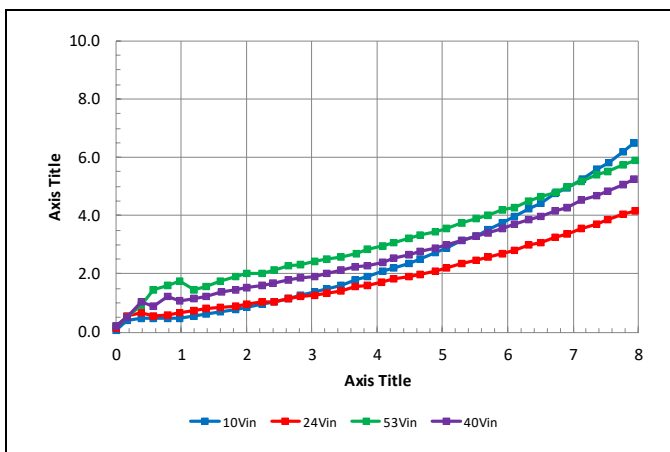

Vo = 12V

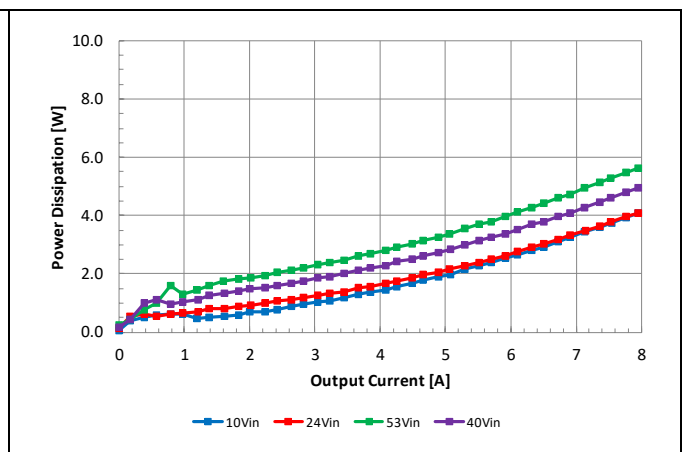

Vo = 9.6V

Static Characteristic:

i7C4W008A120V-xxx-R (Vo = 12V)

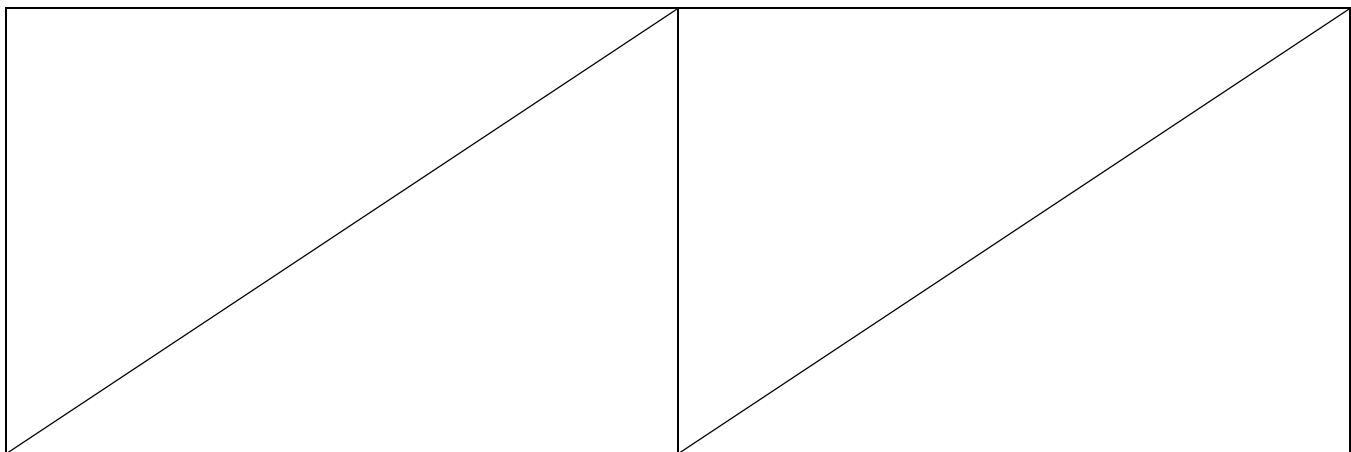
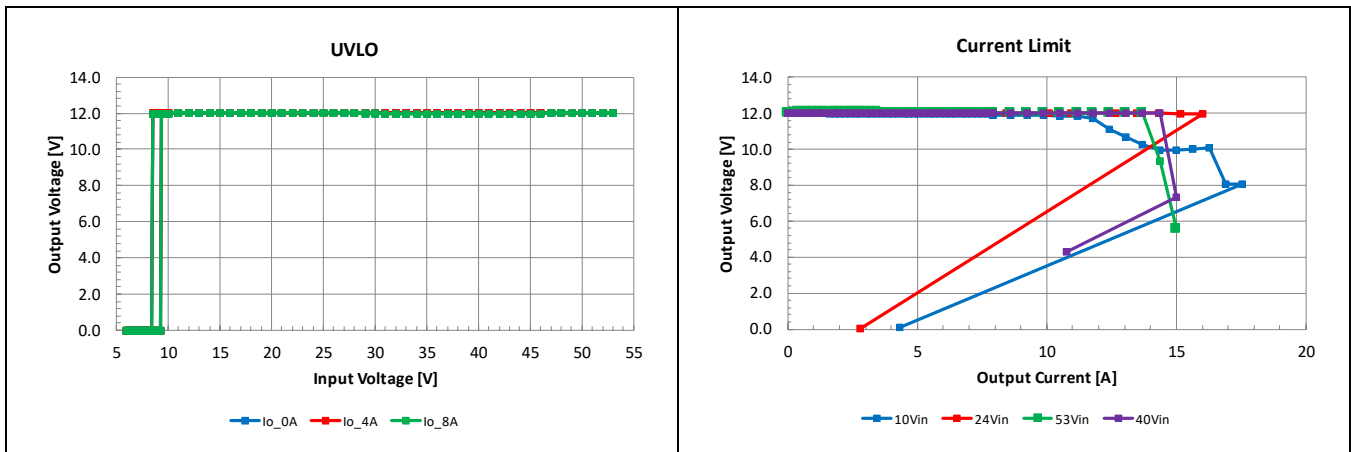
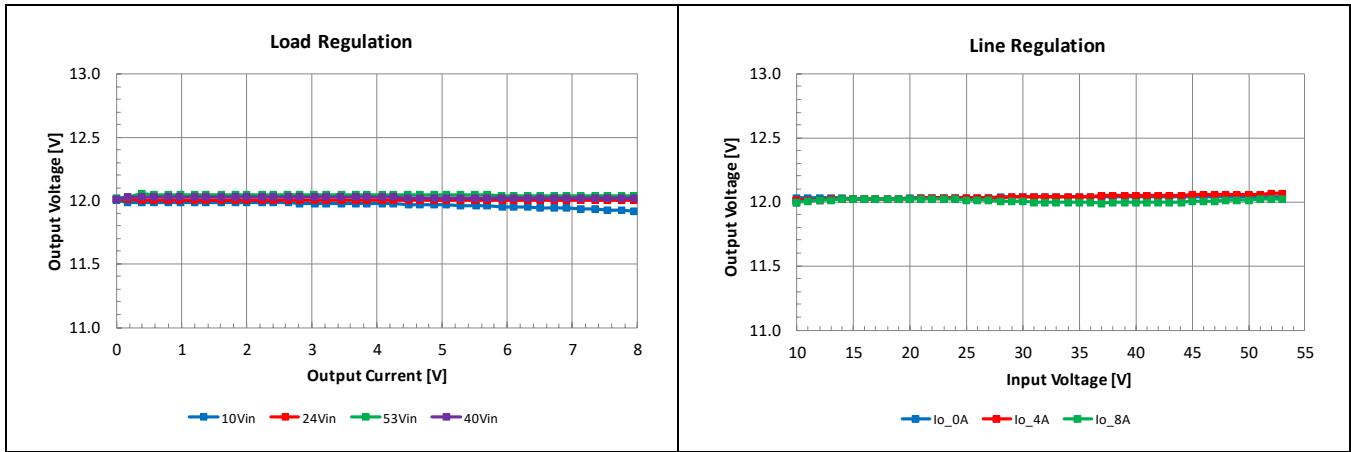

Typical Waveform:

i7C4W008A120V-xxx-R (Vo = 12V)

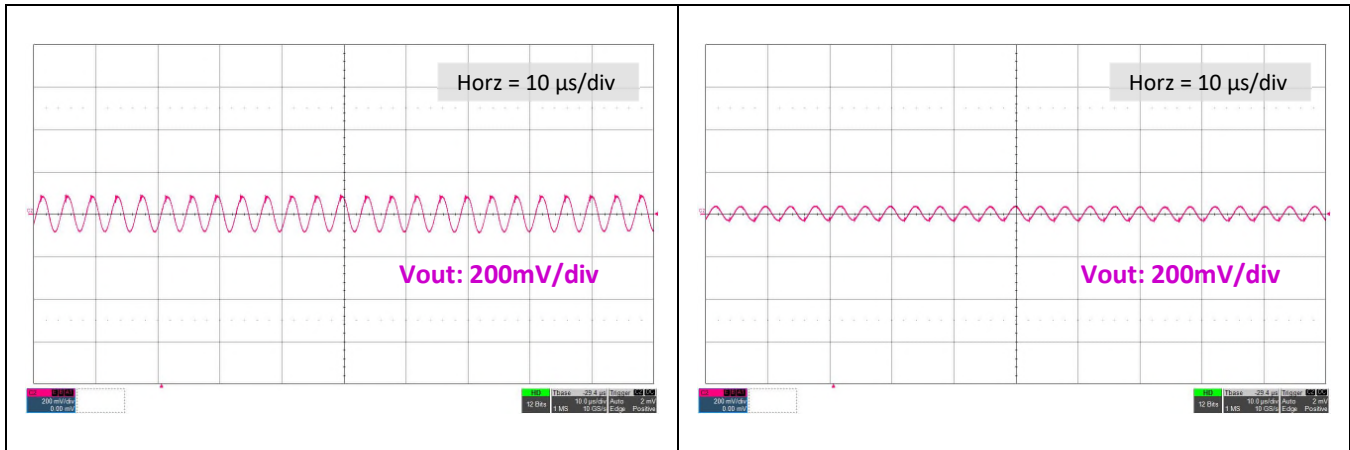

Typical Output Ripple at full load with step-up mode; Vin=10V, Vo=12V, Io=8.0A; Cext=330μF with 60mohm ESR of electrolytic capacitor.

Typical Output Ripple at full load with step-down mode; Vin=24V, Vo=12V, Io=8.0A; Cext=330μF with 60mohm ESR of electrolytic capacitor

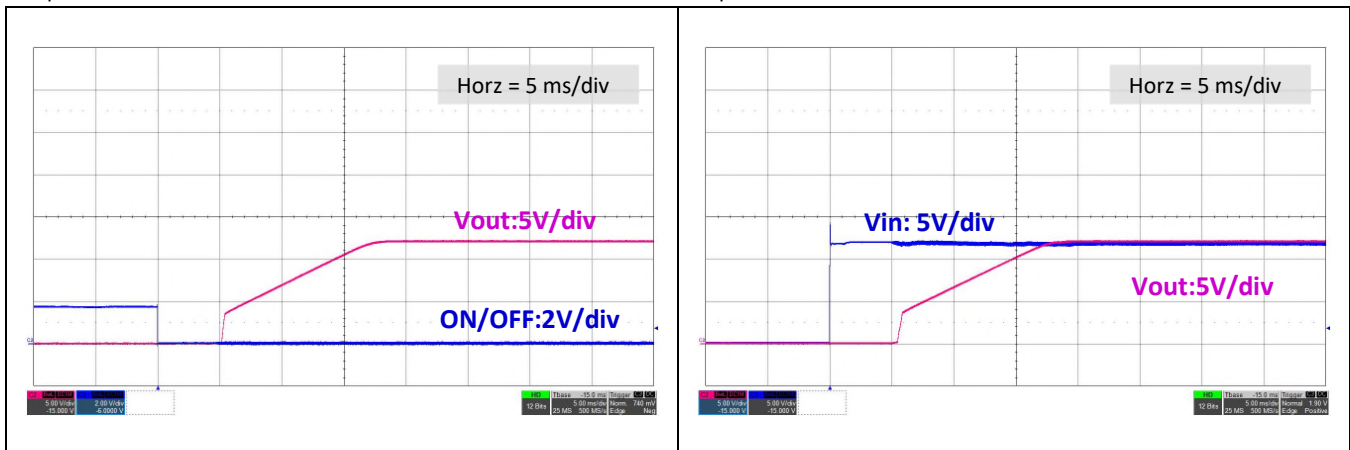

Typical startup characteristic from on/off at full load; Vin=12V, Vo=12V, Io=8.0A, Cext=330μF.

Typical startup characteristic from Vin at full load; Vin=12V, Vo=12V, Io=8.0A, Cext=330μF.

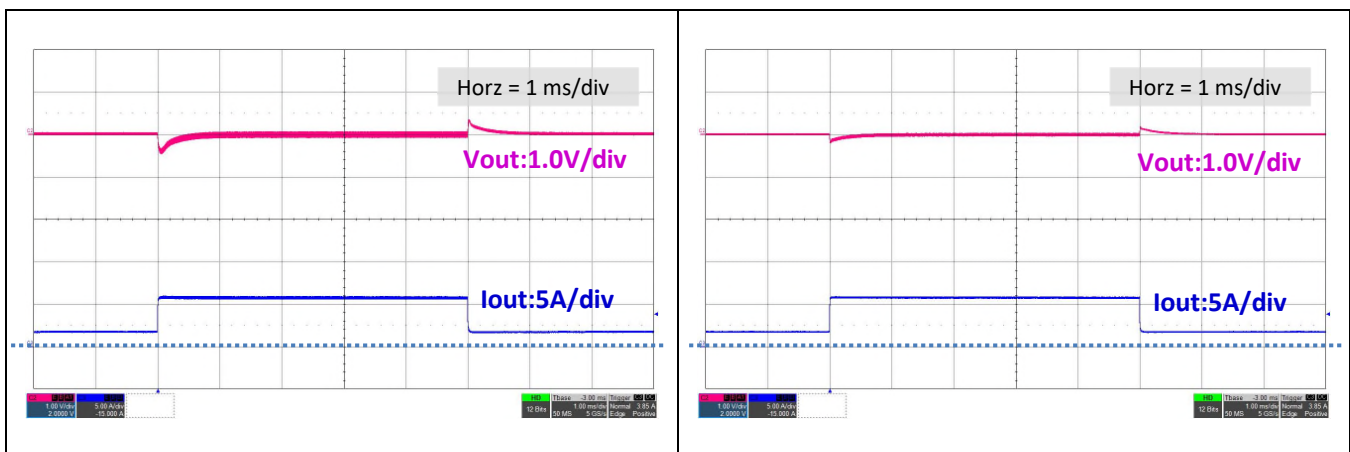

Typical Load transient response with step-up mode; Load Step from/to 25%(2A) and 75%(6A) with Slew rate of 1.0A/μs; Vin=10V, Vo=12V Cext = 330μF.

Typical Load transient response with step-down mode; Load Step from/to 25%(2A) and 75%(6A) with Slew rate of 1.0A/μs; Vin=24V, Vo=12V Cext = 330μF.

Static Characteristic:

i7C4W008A120V-xxx-R (Vo = 24V)

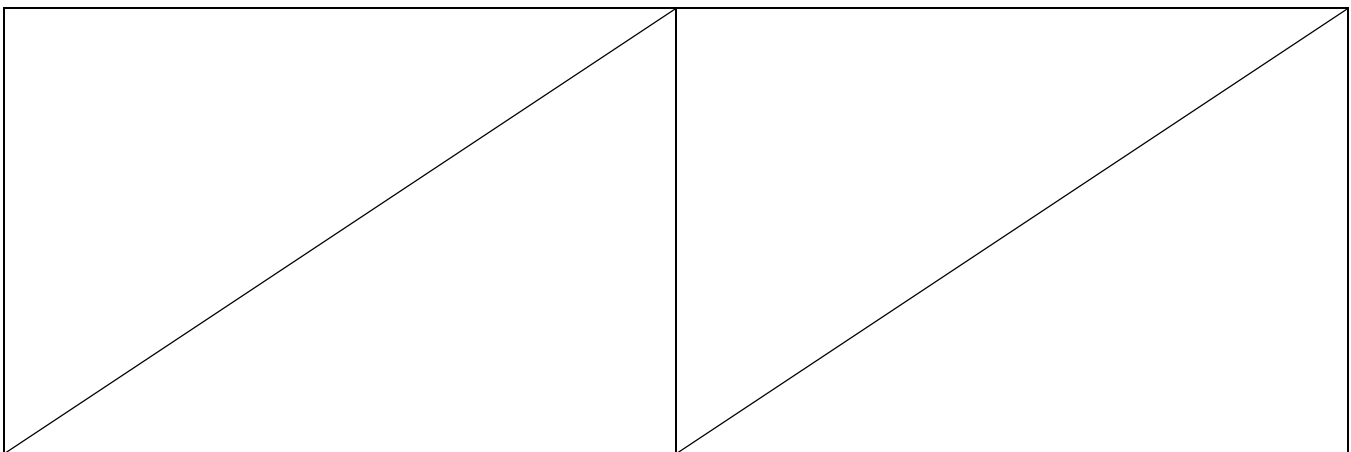
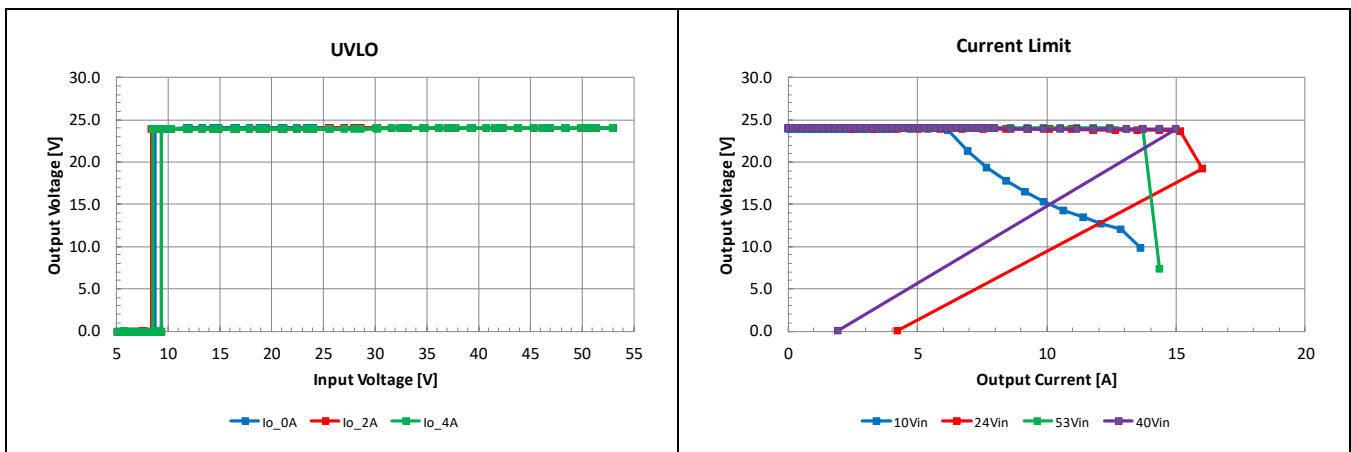
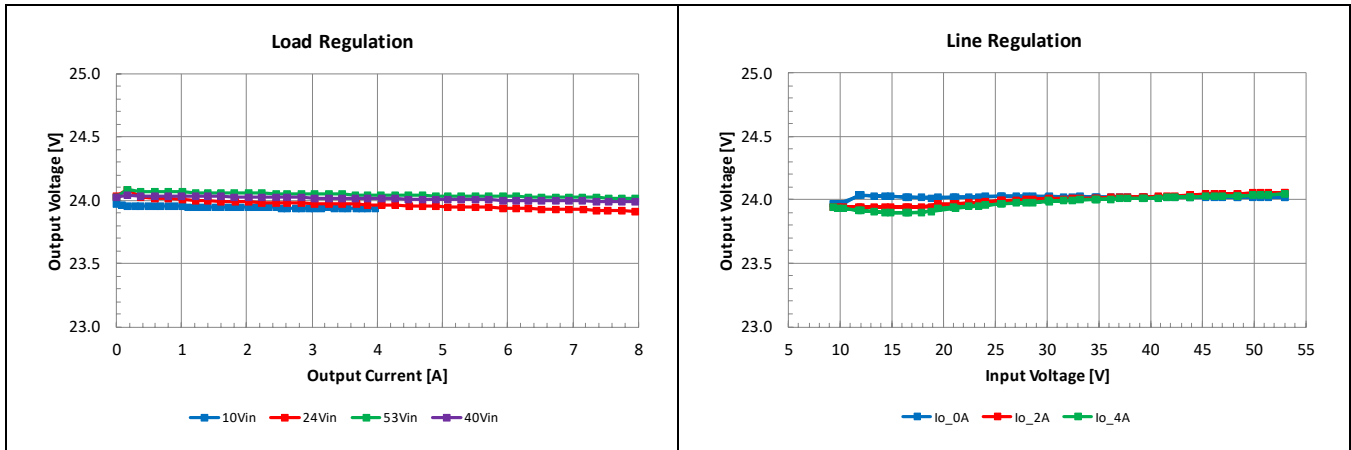

Typical Waveform:

i7C4W008A120V-xxx-R ($V_o = 24V$)

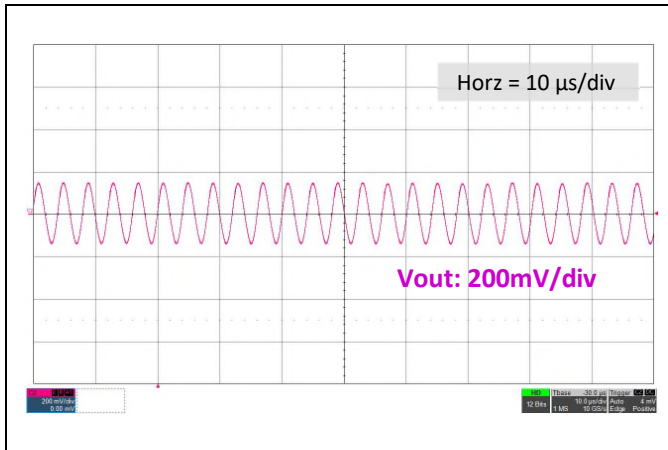

Typical Output Ripple at full load with step-up mode; $V_{in}=10V$, $V_o=24V$, $I_o=4.0A$; $C_{ext}=330\mu F$ with 60mohm ESR of electrolytic capacitor.

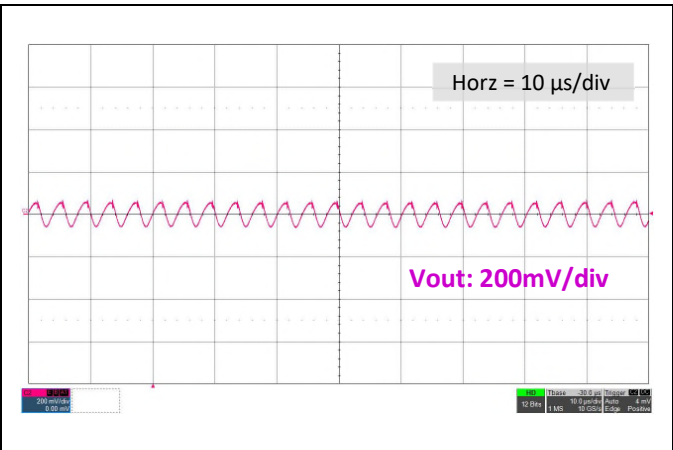

Typical Output Ripple at full load with step-down mode; $V_{in}=24V$, $V_o=24V$, $I_o=8.0A$; $C_{ext}=330\mu F$ with 60mohm ESR of electrolytic capacitor.

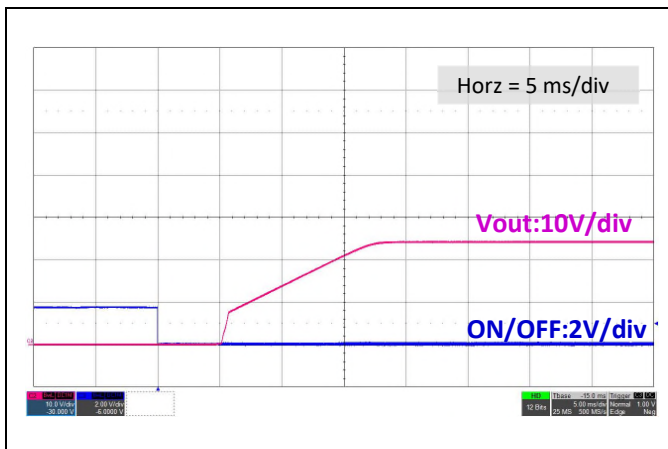

Typical startup characteristic from On/Off at full load; $V_{in}=24V$, $V_o=24V$, $I_o=8A$, $C_{ext}=330\mu F$.

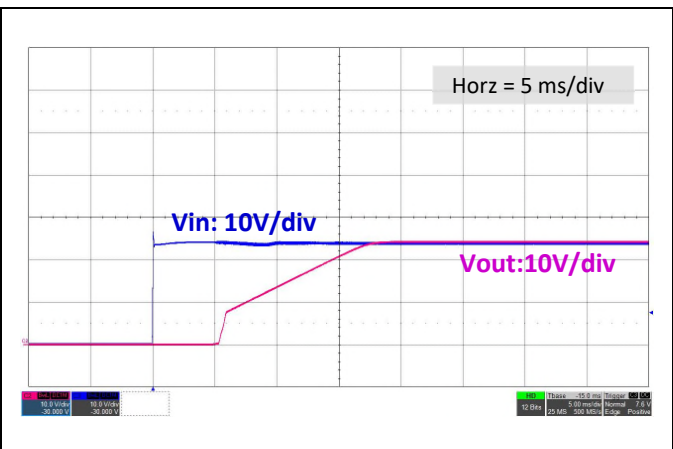

Typical startup characteristic from V_{in} at full load; $V_{in}=24V$, $V_o=24V$, $I_o=8.0A$, $C_{ext}=330\mu F$.

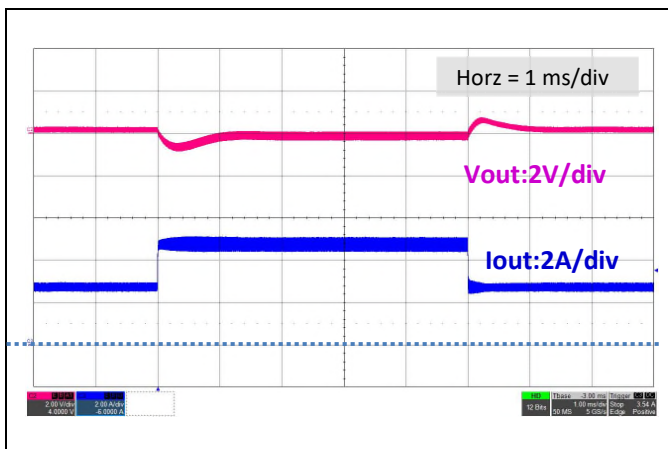

Typical Load transient response with step-up mode; Load Step from/to 25%(1A) and 75%(3A) with Slew rate of $1.0A/\mu s$; $V_{in}=10V$, $V_o=24V$ $C_{ext} = 330\mu F$.

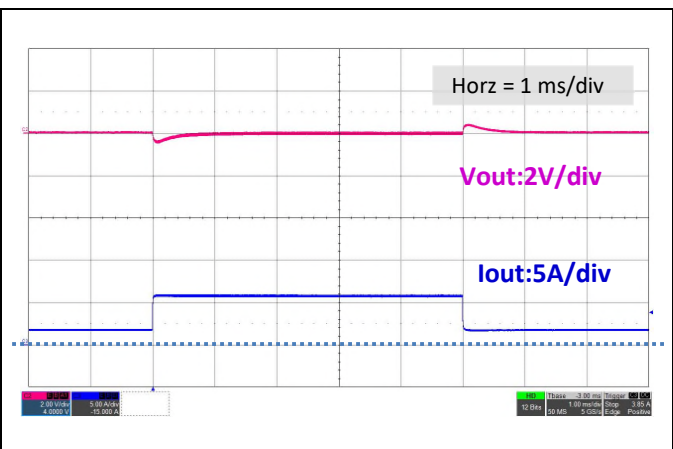

Typical Load transient response with step-down mode; Load Step from/to 25%(2A) and 75%(6A) with Slew rate of $1.0A/\mu s$; $V_{in}=53V$, $V_o=24V$ $C_{ext} = 330\mu F$.

Thermal Performance: i7C4W008A120V (Open frame –00x-R)

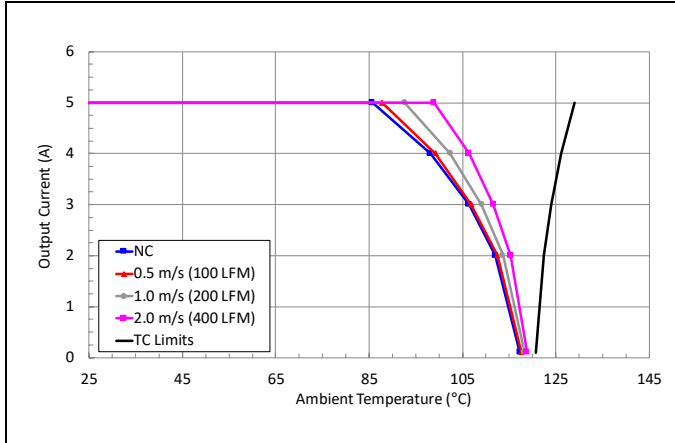

Vin=12V, Vo=24V preliminary maximum output current vs. ambient temperature for natural convection (60lfm) to 2m/s (400 lfm) with airflow from pin 3 to pin 4.

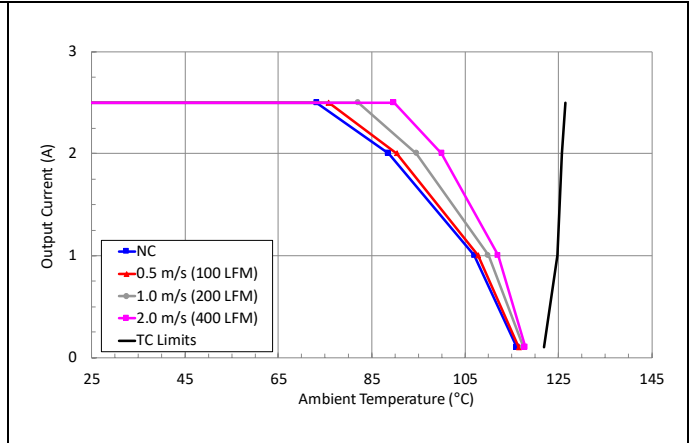

Vin=12V, Vo=48V preliminary maximum output current vs. ambient temperature for natural convection (60lfm) to 2m/s (400 lfm) with airflow from pin 3 to pin 4.

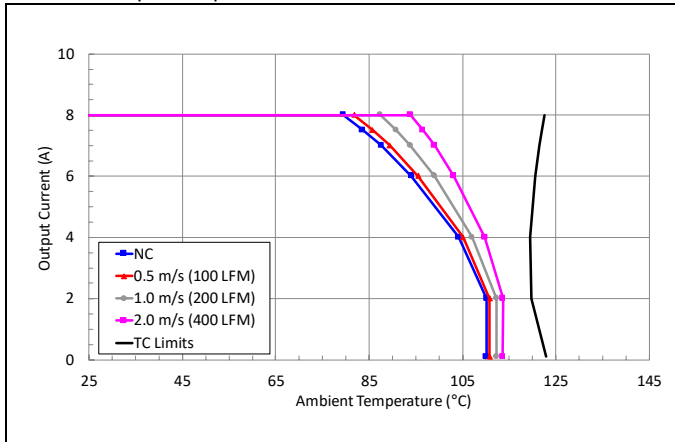

Vin=24V, Vo=24V preliminary maximum output current vs. ambient temperature for natural convection (60lfm) to 2m/s (400 lfm) with airflow from pin 3 to pin 4.

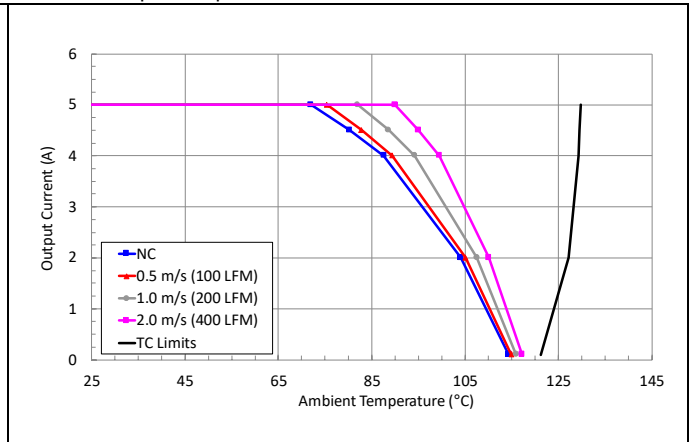

Vin=24V, Vo=48V preliminary maximum output current vs. ambient temperature for natural convection (60lfm) to 2m/s (400 lfm) with airflow from pin 3 to pin 4.

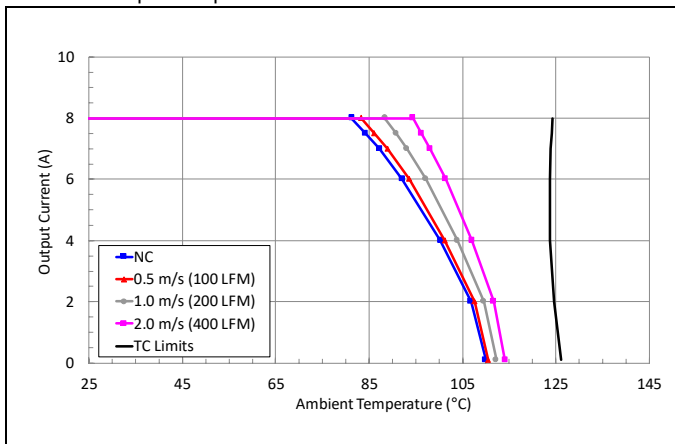

Vin=48V, Vo=24V preliminary maximum output current vs. ambient temperature for natural convection (60lfm) to 2m/s (400 lfm) with airflow from pin 3 to pin 4.

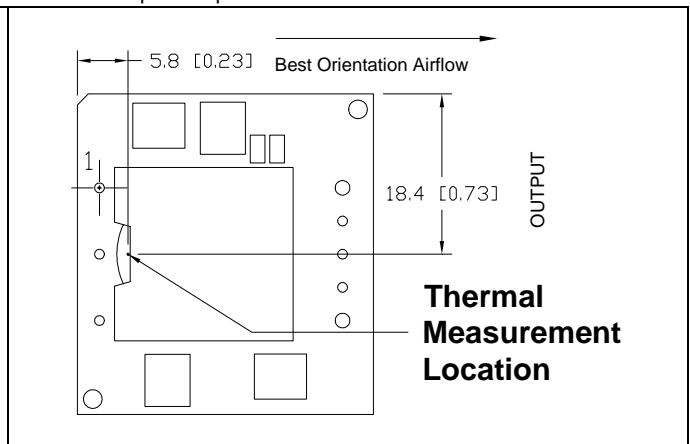

The thermal curves provided are based on measurements made in TDK Lambda's test setup that is described in the Thermal Management section. Due to the large number of variables in system design and the extremely wide operating range of the module, TDK Lambda recommends that the user verify the module's thermal performance in the end application. The critical component should be thermocoupled, monitored and should not exceed the temperature limit specified in the derating curve above. It is critical that the thermocouple be mounted in a manner that gives direct thermal contact or significant measurement errors may result. TDK Lambda can provide modules with a thermocouple pre-mounted to the critical component for system verification tests.

Thermal Performance: i7C4W008A120V (With Heat sink -0Fx-R)

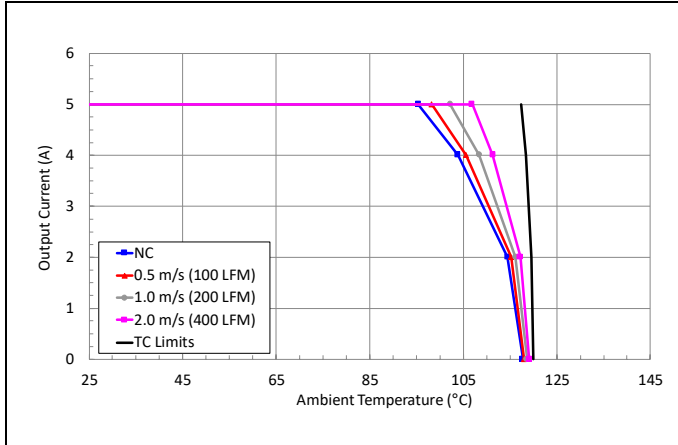

Vin=12V, Vo=24V preliminary maximum output current vs. ambient temperature for natural convection (60lfm) to 2m/s (400 lfm) with airflow from pin 3 to pin 4.

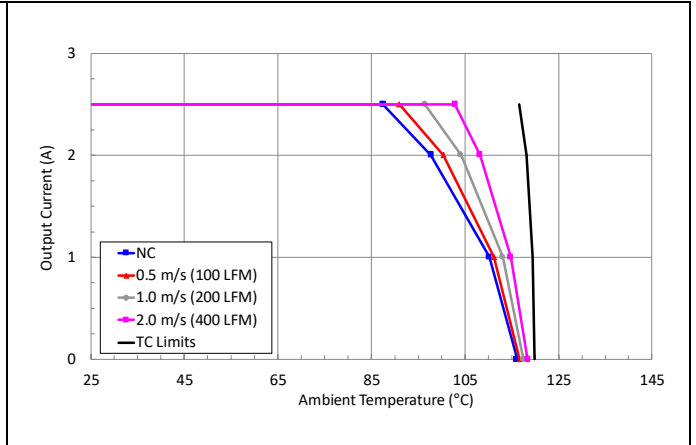

Vin=12V, Vo=48V preliminary maximum output current vs. ambient temperature for natural convection (60lfm) to 2m/s (400 lfm) with airflow from pin 3 to pin 4.

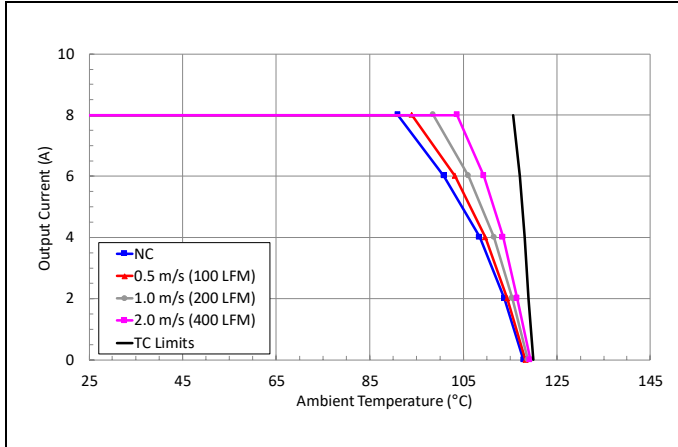

Vin=24V, Vo=24V preliminary maximum output current vs. ambient temperature for natural convection (60lfm) to 2m/s (400 lfm) with airflow from pin 3 to pin 4.

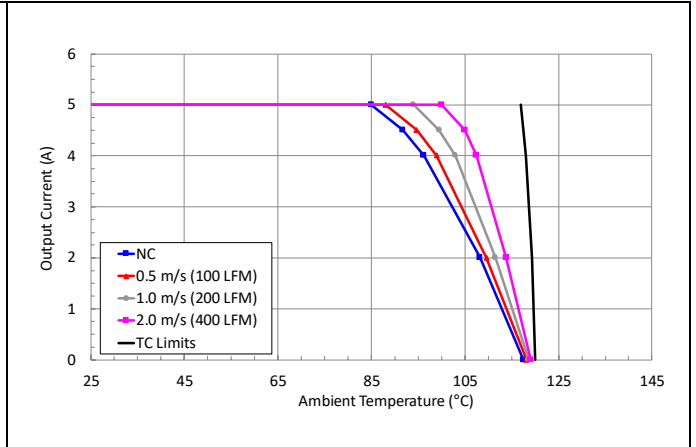

Vin=24V, Vo=48V preliminary maximum output current vs. ambient temperature for natural convection (60lfm) to 2m/s (400 lfm) with airflow from pin 3 to pin 4.

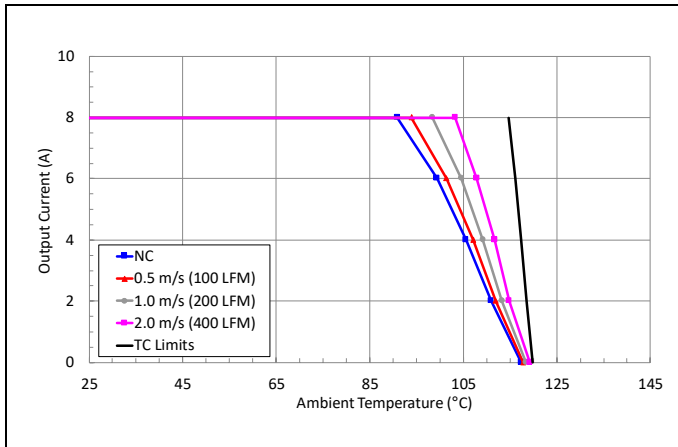

Vin=48V, Vo=24V preliminary maximum output current vs. ambient temperature for natural convection (60lfm) to 2m/s (400 lfm) with airflow from pin 3 to pin 4.

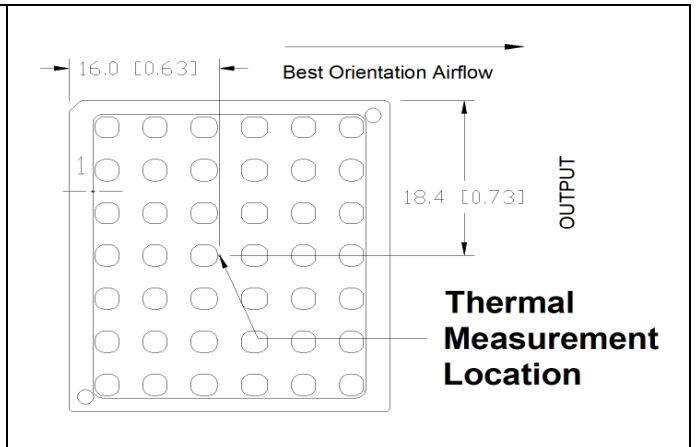

Thermal Performance: i7C4W008A120V (With base plate –0Cx-R)

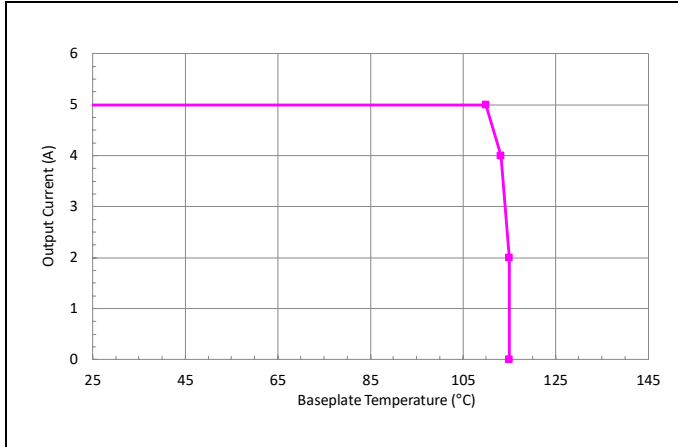

Vin=12V, Vo=24V preliminary maximum output current vs. baseplate temperature with enclosed environment.

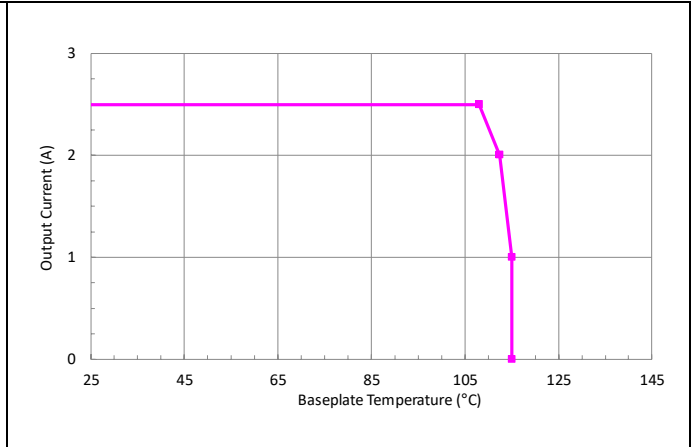

Vin=12V, Vo=48V preliminary maximum output current vs. baseplate temperature with enclosed environment.

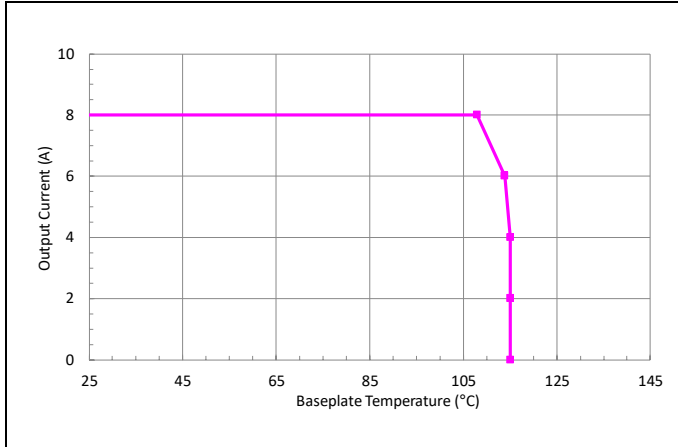

Vin=24V, Vo=24V preliminary maximum output current vs. baseplate temperature with enclosed environment.

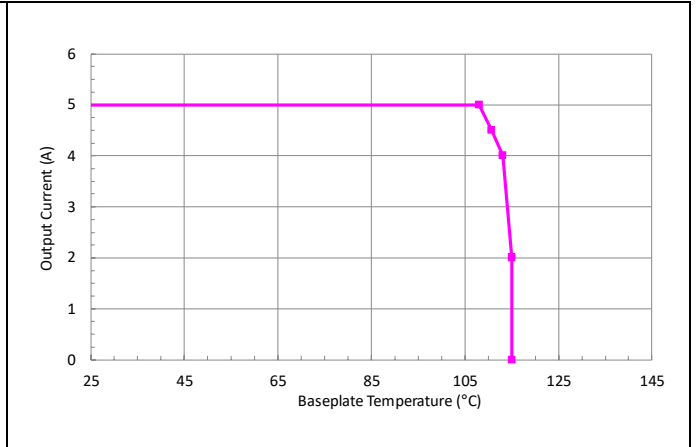

Vin=24V, Vo=48V preliminary maximum output current vs. baseplate temperature with enclosed environment.

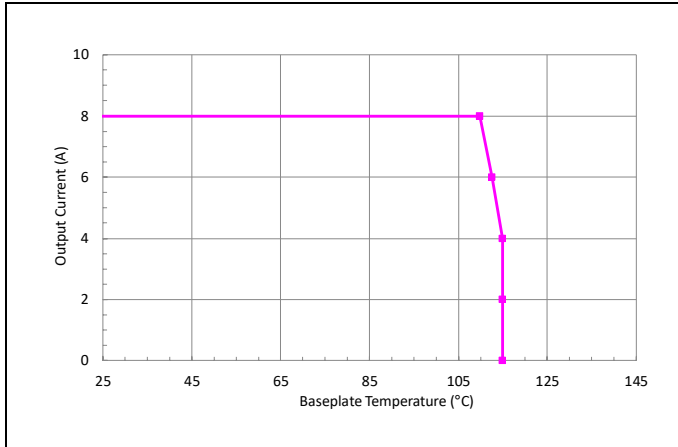

Vin=48V, Vo=24V preliminary maximum output current vs. baseplate temperature with enclosed environment.

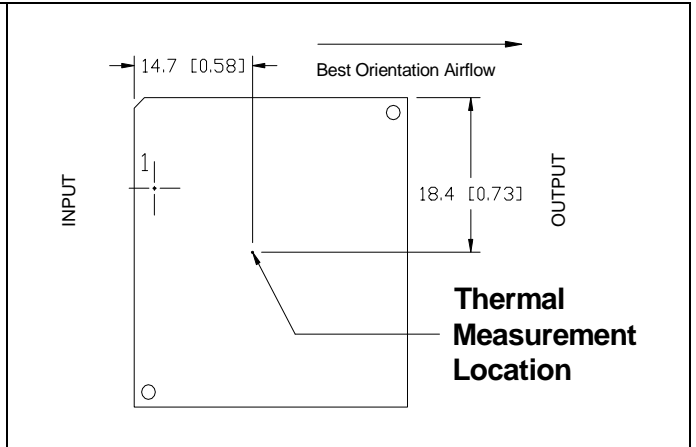

Thermal Management:

An important part of the overall system design process is thermal management; thermal design must be considered at all levels to ensure good reliability and lifetime of the final system. Superior thermal design and the ability to operate in severe application environments are key elements of a robust, reliable power module.

A finite amount of heat must be dissipated from the power module to the surrounding environment. This heat is transferred by the three modes of heat transfer: convection, conduction and radiation. While all three modes of heat transfer are present in every application, convection is the dominant mode of heat transfer in most applications. However, to ensure adequate cooling and proper operation, all three modes should be considered in a final system configuration.

The open frame design of the power module provides an air path to individual components. This air path improves convection cooling to the surrounding environment, which reduces areas of heat concentration and resulting hot spots.

Test Setup:

The thermal performance data of the power module is based upon measurements obtained from a wind tunnel test with the setup shown in the wind tunnel figure. This thermal test setup replicates the typical thermal environments encountered in most modern electronic systems with distributed power architectures. The electronic equipment in networking, telecom, wireless, and advanced computer systems operates in similar environments and utilizes vertically mounted PCBs or circuit cards in cabinet racks.

The power module, as shown in the figure, is mounted on a printed circuit board (PCB) and is vertically oriented within the wind tunnel. The cross section of the airflow passage is rectangular. The spacing between the top of the module and a parallel facing PCB is kept at a constant (0.5 in). The power module's orientation with respect to the airflow direction can have a significant impact on the module's thermal performance.

Thermal De-rating:

For proper application of the power module in a given thermal environment, output current de-rating curves are provided as a design guideline on the Thermal Performance section for the power module of interest. The module temperature should be measured in the final system configuration to ensure proper thermal management of the power module. For thermal performance verification, the module temperature should be measured at the component indicated in the thermal measurement location figure on the thermal performance page for the power module of interest.

In all conditions, the power module should be operated below the maximum operating temperature shown on the de-rating curve. For improved design margins and enhanced system reliability, the power module may be operated at temperatures below the maximum rated operating temperature.

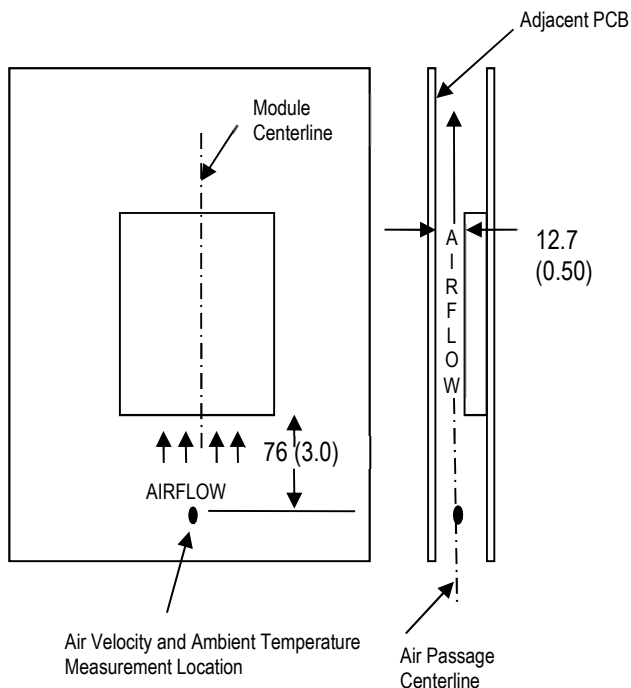

Wind Tunnel Test Setup Figure
(Dimensions are in millimeters and (inches))

Heat transfer by convection can be enhanced by increasing the airflow rate that the power module experiences. The maximum output current of the power module is a function of ambient temperature (T_a) and airflow rate as shown in the thermal performance figures on the thermal performance page for the power module of interest. The curves in the figures are shown for natural convection through 2 m/s (400 ft/min). The data for the natural convection condition has been collected at 0.3 m/s (60 ft/min) of airflow, which is the typical airflow generated by other heat dissipating components in many of the systems that these types of modules are used in. In the final system configurations, the airflow rate for the natural convection condition can vary due to temperature gradients from other heat dissipating components.

Operating Information:

Over-Current Protection:

The power modules have output overload protection to protect the module during severe overload conditions. During overload conditions, the power modules may protect themselves by reducing output voltage to limit power or by entering a hiccup current limit mode. The modules will operate normally once the output current returns to the specified operating range. Long term operation outside the rated conditions and prior to the hiccup protection engaging is not recommended unless measures are taken to ensure the module's thermal limits are being observed.

Thermal Protection:

When the power modules exceed the maximum operating temperature, the modules may turn-off to safeguard the power unit against thermal damage. The module will auto restart as the unit is cooled below the over temperature threshold.

Remote On/Off:

The power modules have an internal Remote On/Off circuit. The user must supply a compatible switch between the GND pin and the On/Off pin. The maximum voltage generated by the power module at the On/Off terminal is 8V. The maximum allowable leakage current of the switch is 10 μ A for negative logic and 5 μ A for positive logic. The switch must be capable of maintaining a low signal $V_{on/off} < 0.25V$ while sinking 1mA. A voltage source should not be applied to the On/Off terminal.

The standard Remote On/Off is negative logic. In the circuit configuration shown the power module will turn on if the external switch is on and it will be off if the external switch is off. If the negative logic feature is not being used, terminal 2 should be connected to ground.

An optional positive logic On/Off logic is available. In the circuit configuration shown the power module will turn off if the external switch is on and it will be on if the switch is off and the On/Off pin is open. If the positive logic feature is not being used, terminal 2 should be left open.

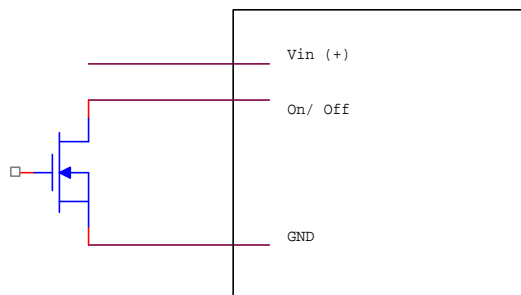

On/Off Circuit for Positive or Negative Logic

Remote Sense:

The power modules feature remote sense to compensate for the effect of output distribution drops. The output voltage sense range defines the maximum voltage allowed between the output power and sense terminals, and it is found on the electrical data page for the power module of interest. If the remote sense feature is not being used, the Sense terminal should be connected to the Vo terminal.

The output voltage at the Vo terminal can be increased by either the remote sense or the output voltage adjustment feature. The maximum voltage increase allowed is the larger of the remote sense range or the output voltage adjustment range; it is not the sum of both. As the output voltage increases due to the use of the remote sense, the maximum output current may need to be decreased for the power module to remain below its maximum power rating.

Output Voltage Adjustment:

The output voltage of the power module may be adjusted by using an external resistor connected between the Vout trim terminal and GND terminal.

Care should be taken to avoid injecting noise into the power module's trim pin

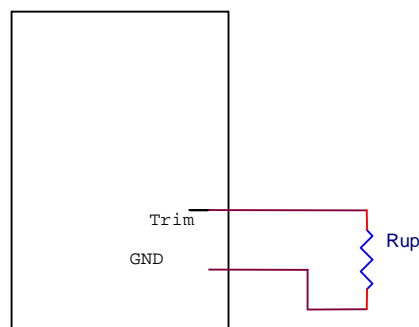

Circuit to Increase Output Voltage

With a resistor between the trim and GND terminals, the output voltage is adjusted up. To adjust the output voltage from V_{nom} to $V_{o,up}$ the trim resistor should be chosen according to the following equation:

$$R_{up} = \left(\frac{F \times V_{ref}}{V_{o,up} - V_{nom}} \right) - G$$

Output Voltage Adjustment: (continued)

The values of Vonom, G, and F are found in the electrical data section for the power module of interest. The maximum power available from the power module is fixed. As the output voltage is trimmed up, the maximum output current must be decreased to maintain the maximum rated power of the module.

Example 1: i7C4W008A120V to be trimmed up to 12Vout

Given:

- F = 30100
- G = 750
- Vref = 1.0
- Vonom = 9.35 (from Electrical Characteristic table)
- Vo,up = 12 (desired output voltage)

Then,

$$R_{up} = \left(\frac{30100 \times 1.0}{12 - 9.35} \right) - 750 = \mathbf{10608 \Omega}$$

Example 2: i7C4W012A050V to be trimmed up to 12Vout

Given:

- F = 30100
- G = 1000
- Vref = 1.0
- Vonom = 5 (from Electrical Characteristic table)
- Vo,up = 12 (desired output voltage)

Then,

$$R_{up} = \left(\frac{30100 \times 1.0}{12 - 5.013} \right) - 1000 = \mathbf{3308 \Omega}$$

Trim Table for i7C4W008A120V

Vout	Rup(ohm)
9.4	OPEN
9.6	125k
12.0	10.6k
18.0	2730
24.0	1306
28.0	865
48.0	29

Trim Table for i7C4W120A050V

Vout	Rup(ohm)
5.0	OPEN
9.6	5563
12.0	3308
15.0	2014
18.0	1318
24.0	585
28.0	310

Power Good:

The power module features an optional open-drain Power Good signal which indicates if the output voltage is being regulated. When power is applied to the module, and the output voltage is typically within ±12% of the nominal voltage set point the Power Good will be pulled to ground through a 250-ohm maximum impedance. If the voltage is outside of the range due to input under voltage, over temperature, over load, or loss of regulation, the Power Good pin will revert to a high impedance state. A 15 kohm resistor is recommended if pulling up to 3.3V source. The voltage on the Power Good pin should be limited to less than 6V in all cases. If the power good feature is not used, the pin should be left open.

Synchronization:

The i7C modules can be synchronized to an external clock within ±15% of nominal value shown on electrical characteristics page by using pin 32 (SYNC).

The SYNC signal should be 50% duty cycle square wave with 2V minimum logic high and 0.4V maximum for logic low. The voltage at the SYNC pin should be less than 5.25V.

The SYNC pin must be connected to ground when not in use.

Current Monitor:

The optional Current Monitor pin 34, can be used for estimating the output current being delivered by the i7C power module.

The pin provides a voltage which is linearly related to the output current as indicated in the tables below. The information can be used to assist in determining design margin or to implement external OCP shutdown circuits. The Current Monitor signal is a buffered real time representation of current flowing through an on board current sense circuit near at the power module's output.

Since the Current Monitor signal provides a high ripple signal, an R-C filter, on the order of 0.1 μ F and 1k Ω can be useful to convert the information to a DC-like waveform and extract the average value.

For questions or assistance using the Current Monitor function, please contact TDK Lambda technical support.

Current Monitor Signal:

Iout [A]	Typical Current Monitor Signal [mV]	
	i7C4W008A120V	i7C4W012A050V
0	230	230
2	340	320
4	450	410
6	560	500
8	670	590
10		680
12		790

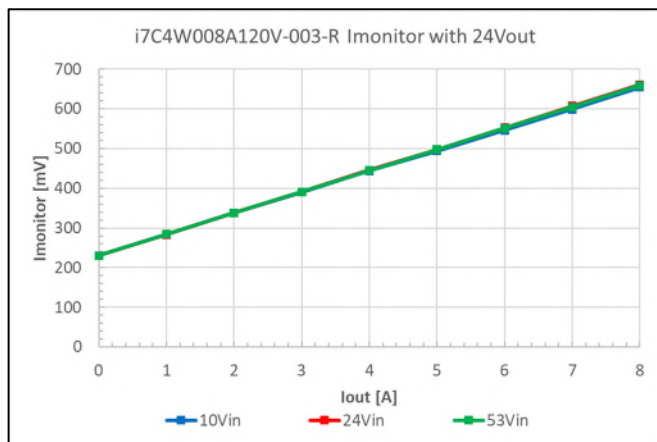

i7C4W008A120V-003-R:
Typical Current Monitor Output Voltage vs. Output Load at Different Input Voltage

EMC Considerations:

TDK-Lambda power modules are designed for use in a wide variety of systems and applications. For assistance with designing for EMC compliance, please contact TDK-Lambda technical support.

Input Impedance:

The source impedance of the power feeding the DC/DC converter module will interact with the DC/DC converter. To minimize the interaction, low-ESR capacitors should be located at the input to the module. It is recommended that a 220 μ F-440 μ F input capacitor be placed near the module.

Reliability:

The power modules are designed using TDK Lambda's stringent design guidelines for component derating, product qualification, and design reviews. The MTBF is calculated to be greater than 10 million hours at full output power and Ta = 40°C using the Telcordia SR-332 calculation method.

Quality:

TDK Lambda's product development process incorporates advanced quality planning tools such as FMEA and Cpk analysis to ensure designs are robust and reliable. All products are assembled at ISO certified assembly plants.

Input / Output Ripple and Noise Measurements:

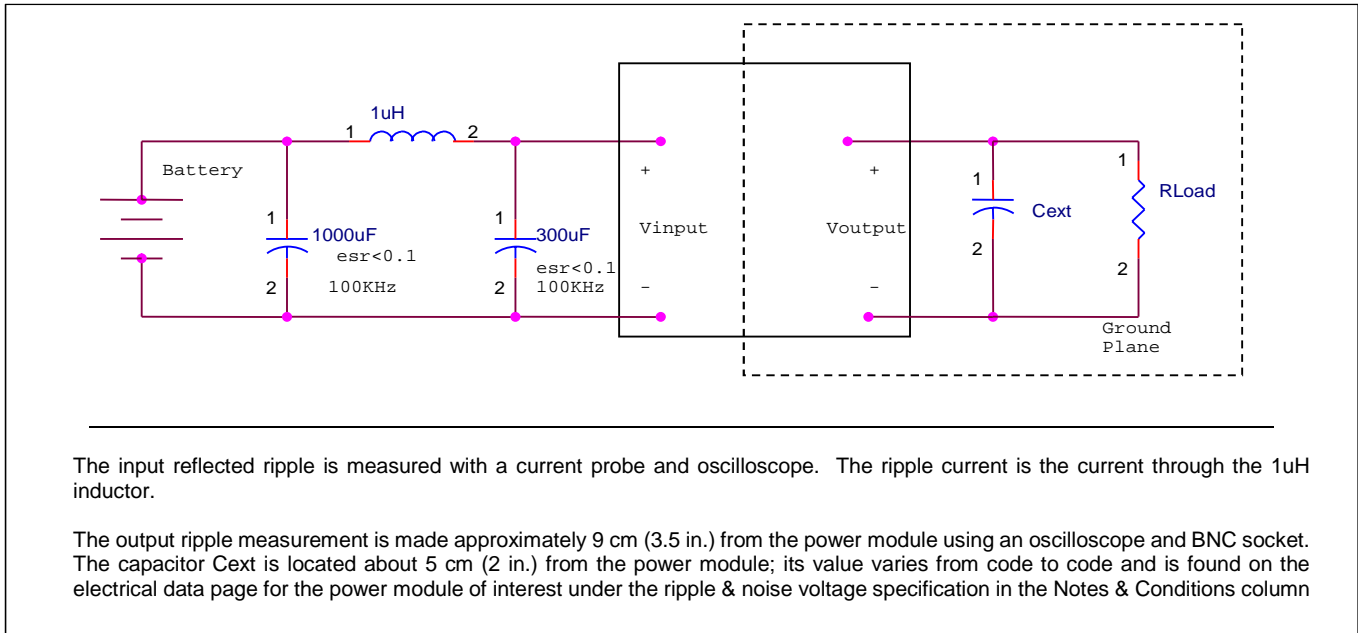

Safety Considerations:

As of the publishing date, certain safety agency approvals may have been received on the i7C series and others may still be pending. Check with TDK-Lambda for the latest status of safety approvals on the i7C product line.

For safety agency approval of the system in which the DC-DC power module is installed, the power module must be installed in compliance with the creepage and clearance requirements of the safety agency.

To preserve maximum flexibility, the power modules are not internally fused. An external input line normal blow fuse with a maximum value of 30A is required by safety agencies. A lower value fuse can be selected based upon the maximum dc input current and maximum inrush energy of the power module.

Warranty:

TDK Lambda's comprehensive line of power solutions includes efficient, high-density DC-DC converters. TDK Lambda offers a three-year limited warranty. Complete warranty information is listed on our web site or is available upon request from TDK-Lambda.

Information furnished by TDK-Lambda is believed to be accurate and reliable. However, TDK-Lambda assumes no responsibility for its use, nor for any infringement of patents or other rights of third parties, which may result from its use. No license is granted by implication or otherwise under any patent or patent rights of TDK Lambda. TDK components are not designed to be used in applications, such as life support systems, wherein failure or malfunction could result in injury or death. All sales are subject to TDK Lambda's Terms and Conditions of Sale, which are available upon request. Specifications are subject to change without notice.



TDK-Lambda France SAS

Tel: +33 1 60 12 71 65
france@fr.tdk-lambda.com
www.emea.lambda.tdk.com/fr



Italy Sales Office

Tel: +39 02 61 29 38 63
info.italia@it.tdk-lambda.com
www.emea.lambda.tdk.com/it



Netherlands

info@nl.tdk-lambda.com
www.emea.lambda.tdk.com/nl



TDK-Lambda Germany GmbH

Tel: +49 7841 666 0
info.germany@de.tdk-lambda.com
www.emea.lambda.tdk.com/de



Austria Sales Office

Tel: +43 2256 655 84
info@at.tdk-lambda.com
www.emea.lambda.tdk.com/at



Switzerland Sales Office

Tel: +41 44 850 53 53
info@ch.tdk-lambda.com
www.emea.lambda.tdk.com/ch



Nordic Sales Office

Tel: +45 8853 8086
info@dk.tdk-lambda.com
www.emea.lambda.tdk.com/dk



TDK-Lambda UK Ltd.

Tel: +44 (0) 12 71 85 66 66
info@uk.tdk-lambda.com
www.emea.lambda.tdk.com/uk



TDK-Lambda Ltd.

Tel: +9 723 902 4333
info@tdk-lambda.co.il
www.emea.lambda.tdk.com/il



C.I.S.

Commercial Support:

Tel: +7 (495) 665 2627

Technical Support:

Tel: +7 (812) 658 0463
info@tdk-lambda.ru
www.emea.lambda.tdk.com/ru



TDK-Lambda Americas

Tel: +1 800-LAMBDA-4 or 1-800-526-2324
powersolutions@us.tdk-lambda.com
www.us.lambda.tdk.com



TDK Electronics do Brasil Ltda

Tel: +55 11 3289-9599
sales.br@tdk-electronics.tdk.com
www.tdk-electronics.tdk.com/en



TDK-Lambda Corporation

Tel: +81-3-6778-1113
www.jp.lambda.tdk.com



TDK-Lambda (China) Electronics Co. Ltd.

Tel: +86 21 6485-0777
powersolutions@cn.tdk-lambda.com
www.lambda.tdk.com.cn



TDK-Lambda Singapore Pte Ltd.

Tel: +65 6251 7211
tts.mkt@sg.tdk-lambda.com
www.sg.lambda.tdk.com



TDK India Private Limited, Power Supply Division

Tel: +91 80 4039-0660
mathew.philip@in.tdk-lambda.com
www.sg.lambda.tdk.com

