

PROCESS

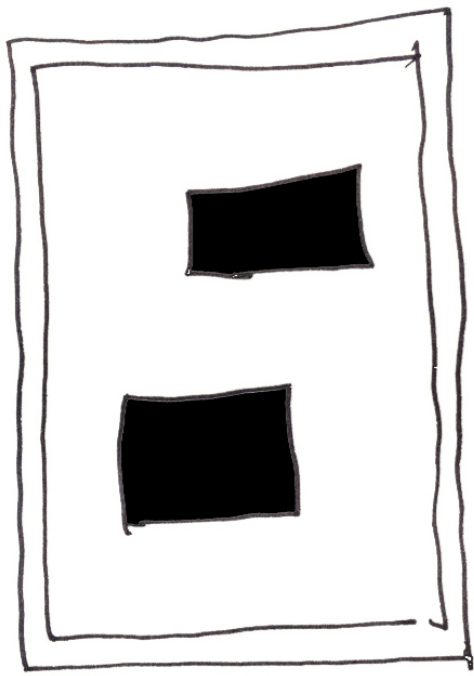

BOXES

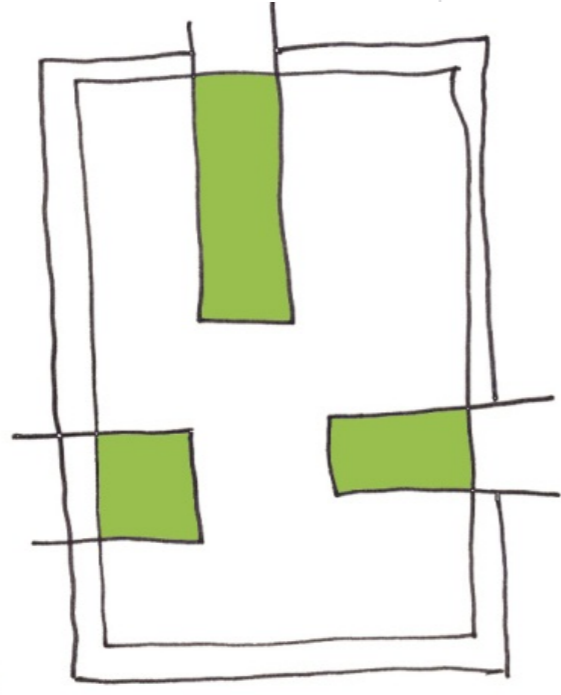

FJORDS

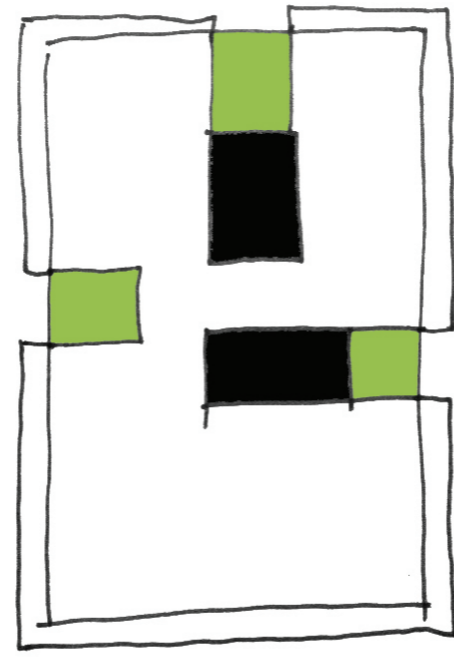

BOXES AND FJORDS

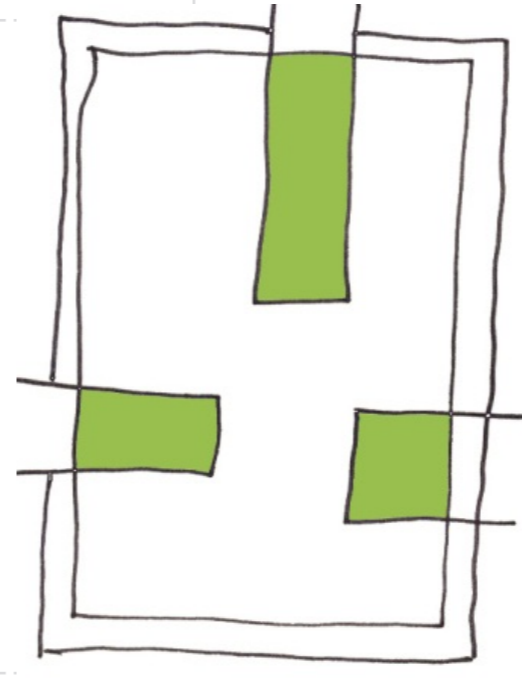

FJORDS AGAIN...

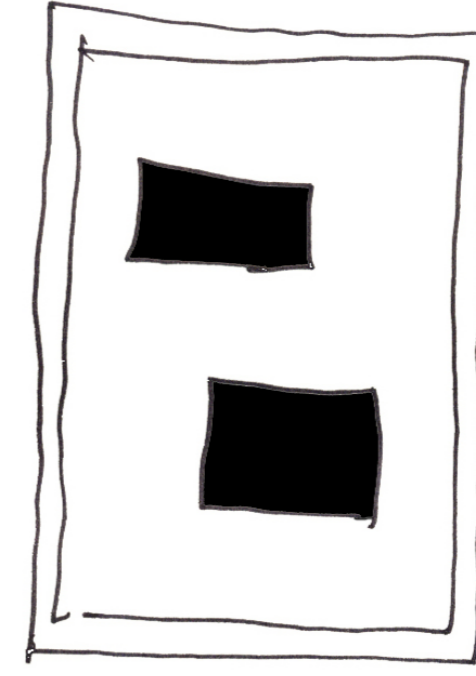

JUST BOXES?

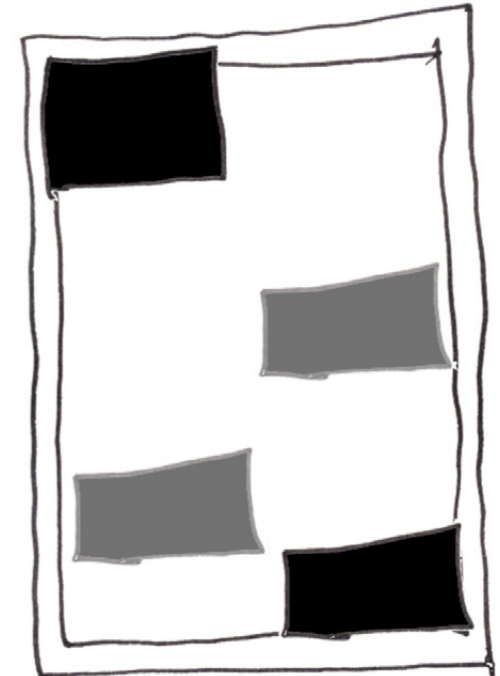

YES, JUST BOXES.

FLEXBOX

SOLAR
DECATHLON
EUROPE
2012

NICO DURR
CHENCHEN GUO
NOORA KHEZRI
KRISTOF LUNEN
BJARTE LYKKE



Why have a large energy guzzling house, where you only use half of it at a time?

FLEX BOX aims to be so flexible that it fits the housing needs for a large amount of the population. This is, of course, because we want it to have a good market viability, but also because we need to change the Norwegian statistics in housing design, where people live on over 50 m² per person.

The house can fit a family of four in only 75 m² by having a flexible floorplan that in simple maneuvers can change from a three-room apartment into one large room, thus filling many of the needs of an average family by simple measures.

The building is producing its own electricity from photovoltaic panels on the roof. By a generous amount of windows it provides large amounts of daylight from every direction. It also very effectively shades its windows in the summer and insulates them in the night. The floor consists of core-activated concrete slabs that helps balance the temperature differences.

All in all it is a sophisticated and efficient house for the future!



Perspective, interior



Site plan

1m 2m 5m

PRINCIPLES

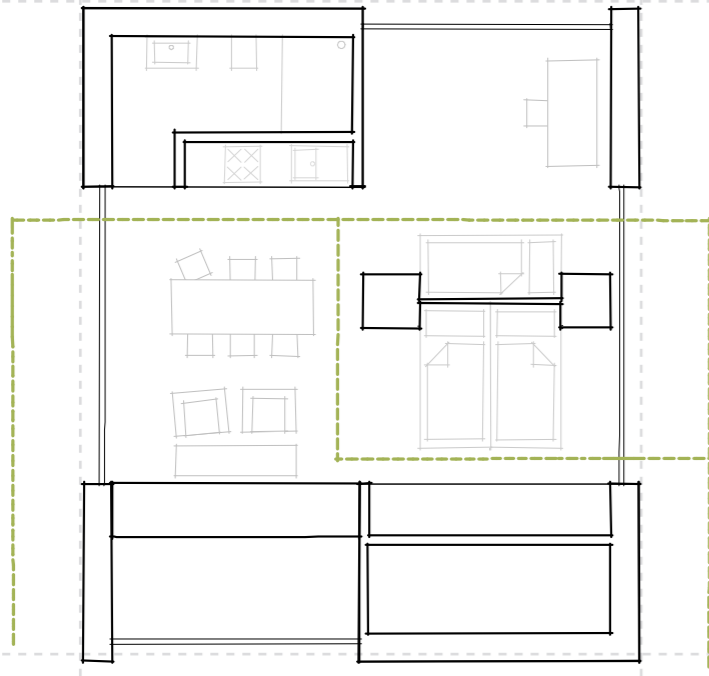

site circulations

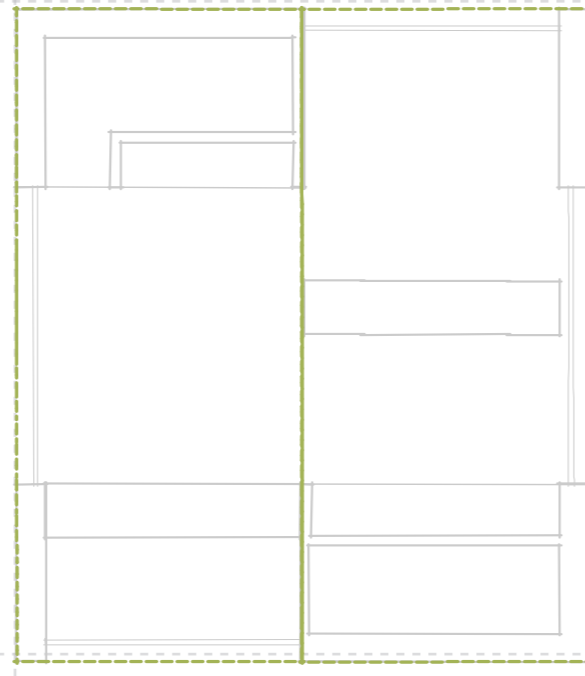

construction module

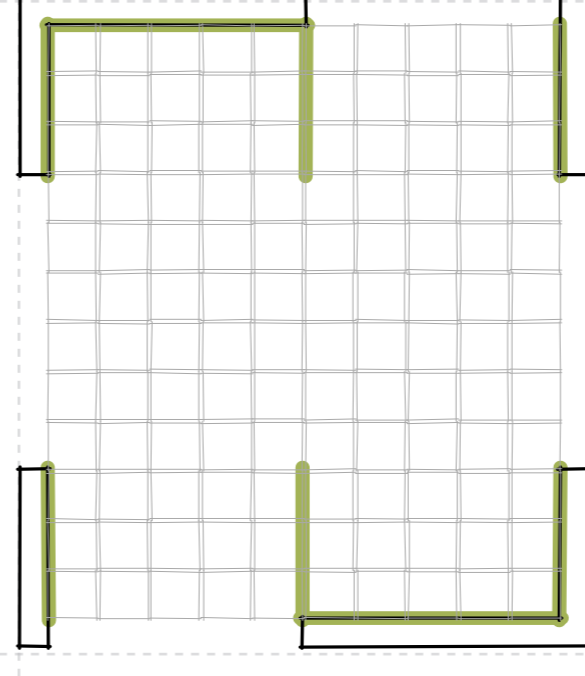

load bearing walls

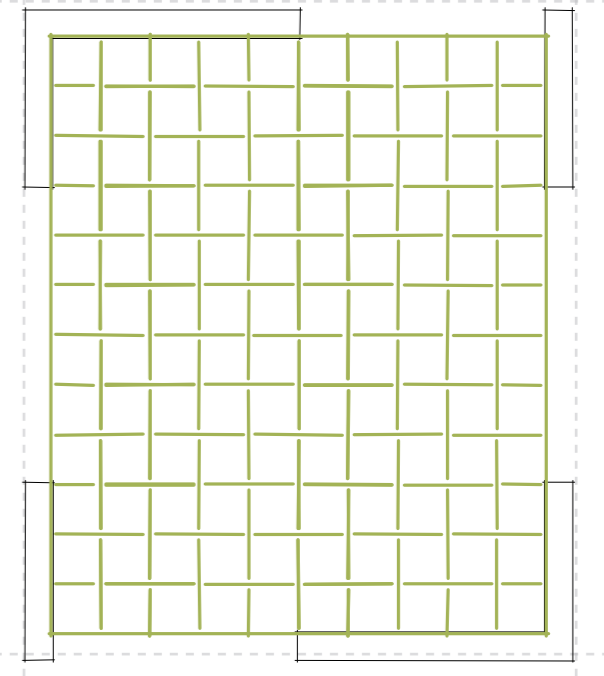

roof raster system

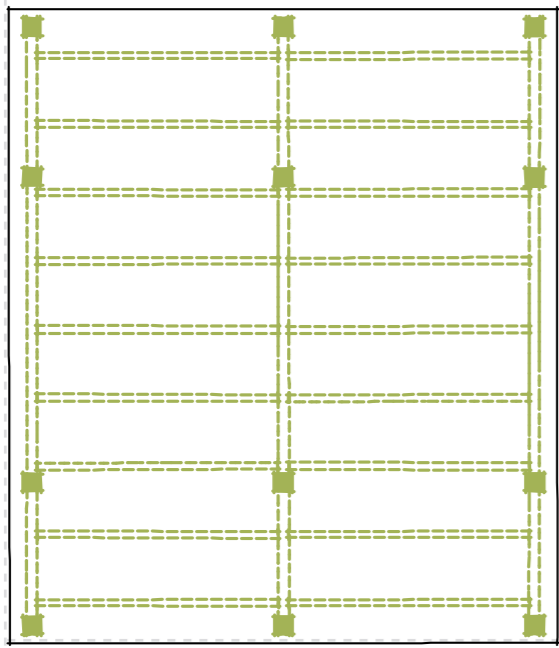

pv carrying system

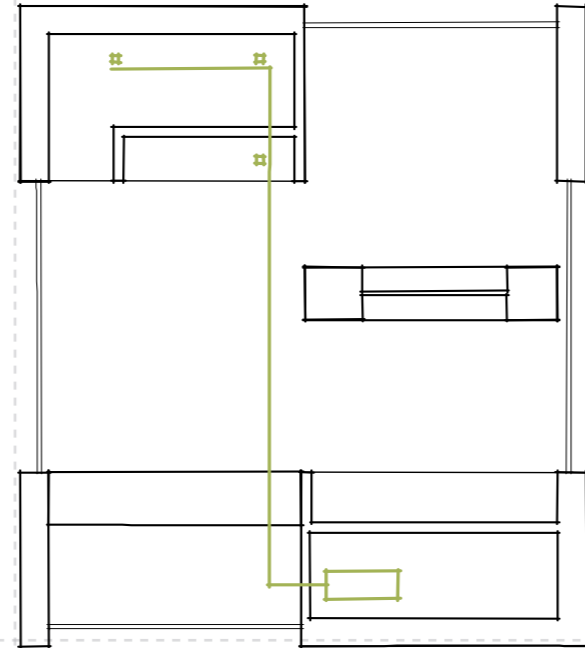

water hot/cold

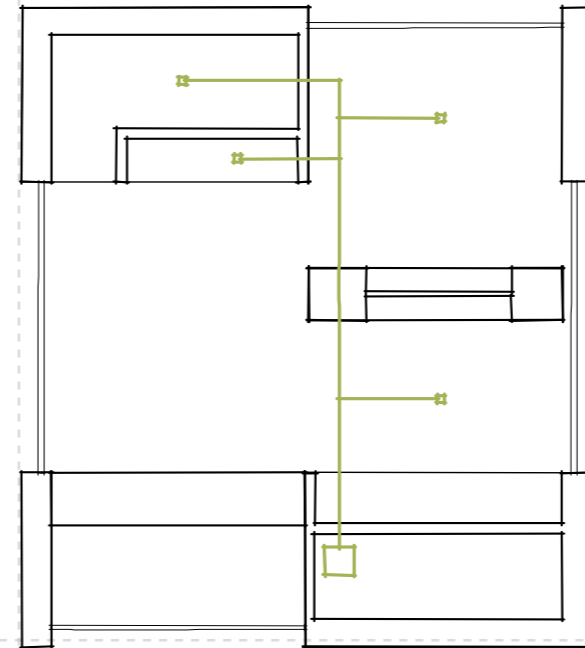

mechanical ventilation

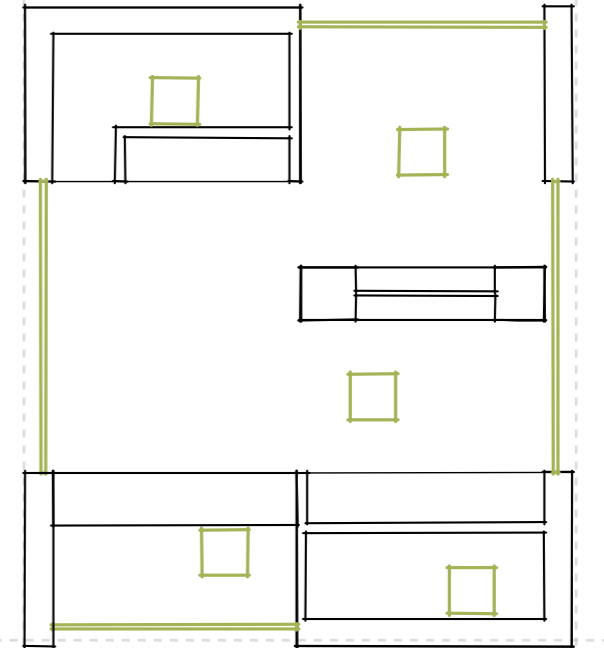

natural ventilation openings

PLAN/SECTIONS/ELEVATION

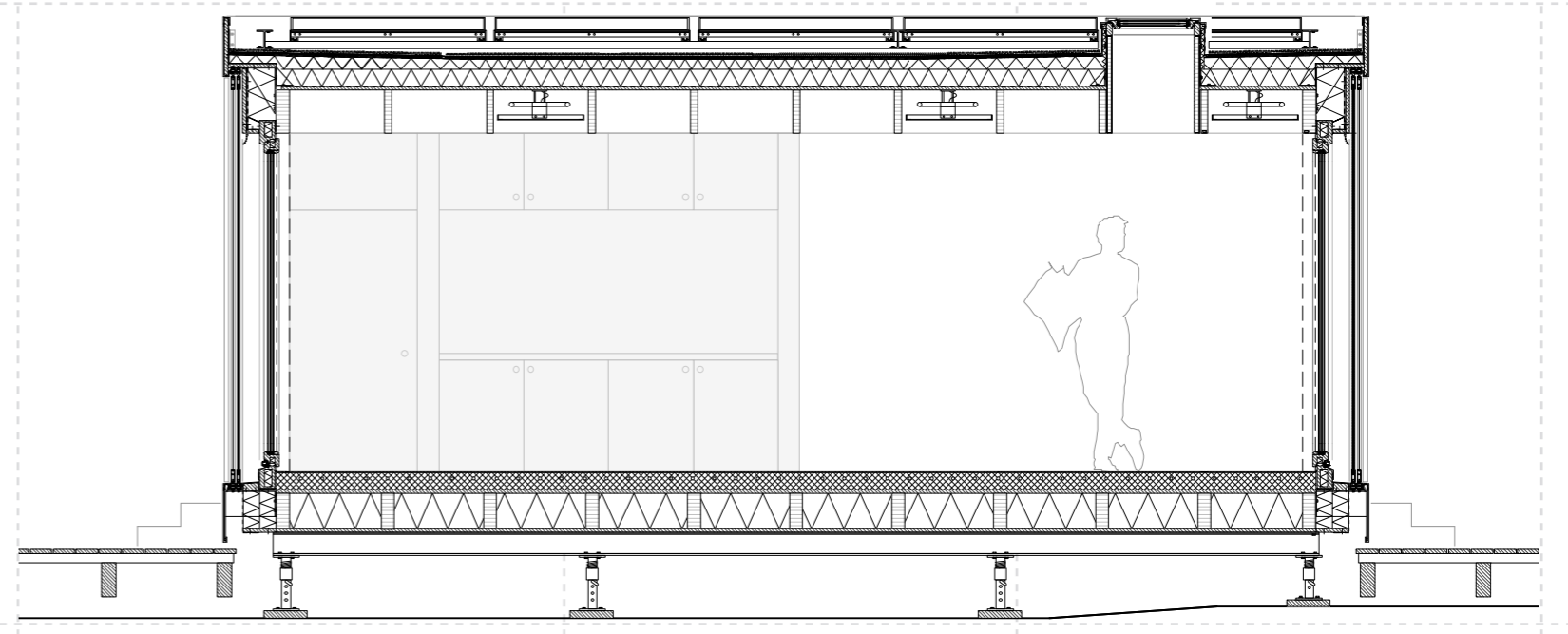
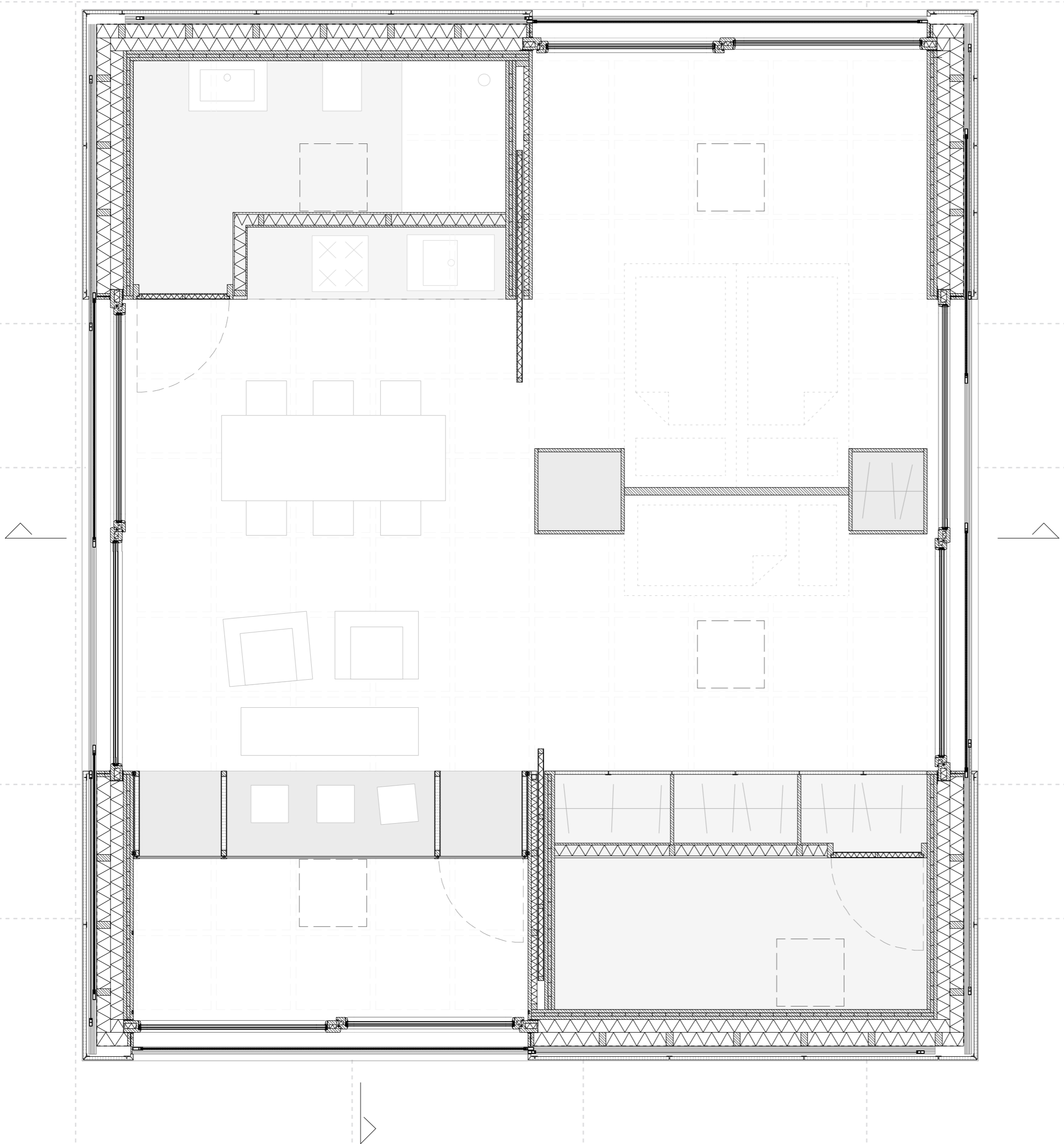

Section E-W 1:50



Elevation 1:50

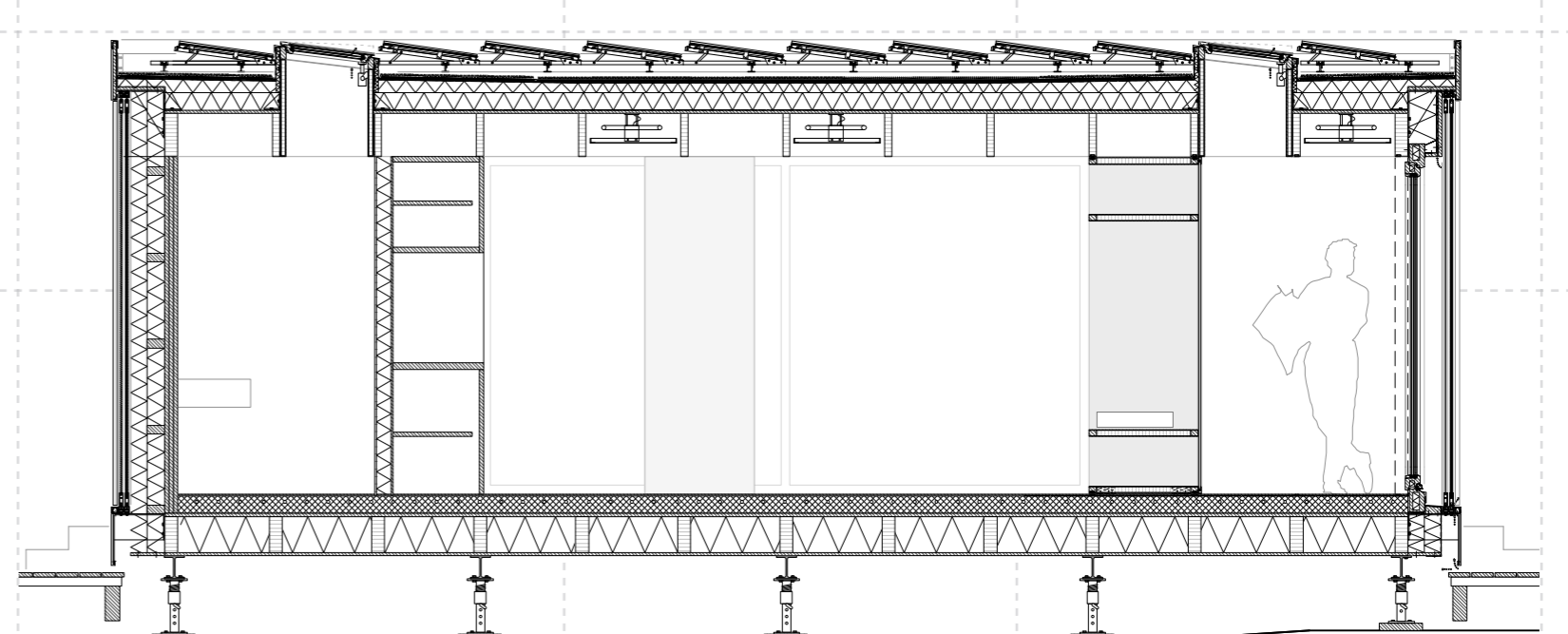

Section N-S 1:50

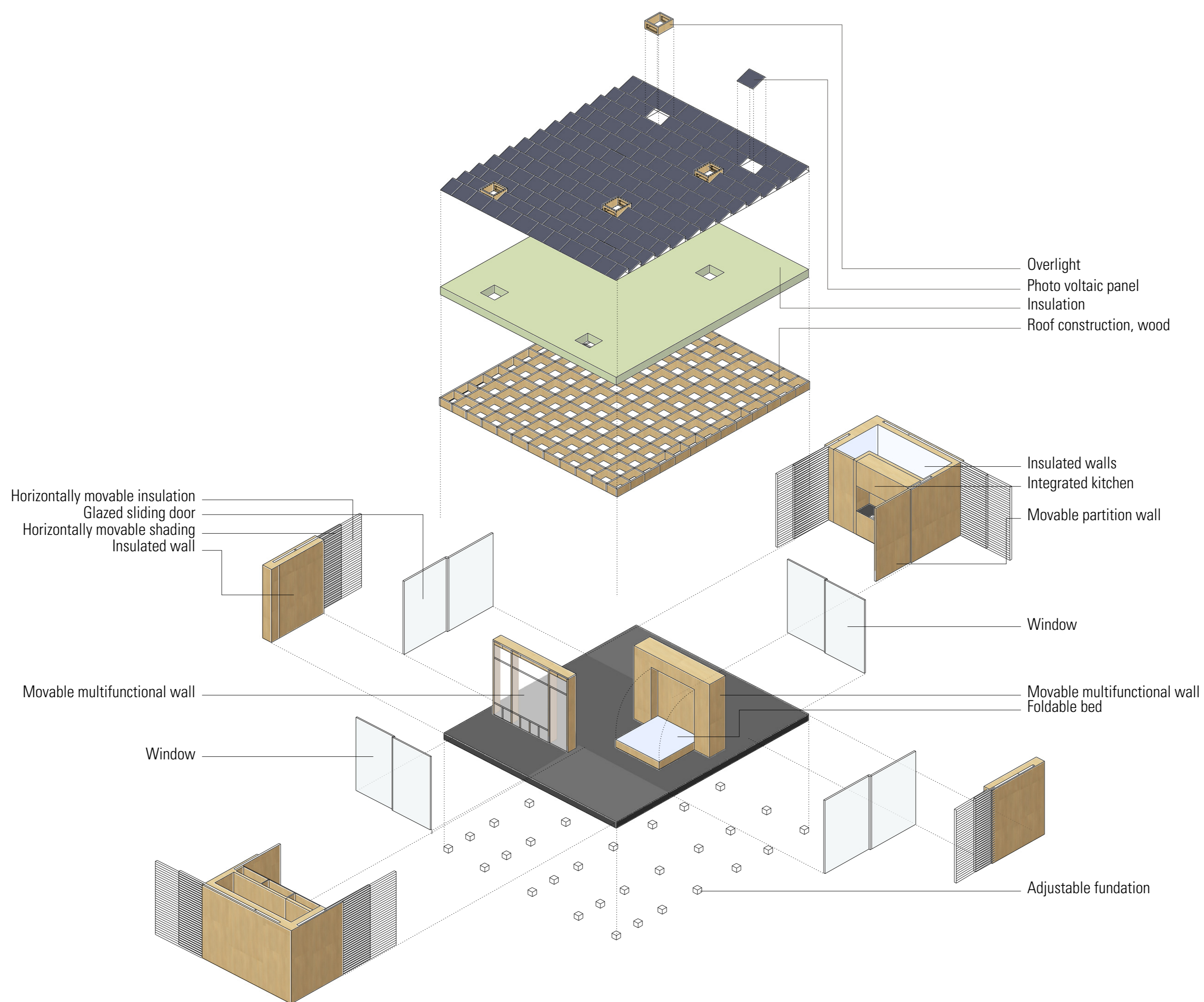

NATURAL VENTILATION

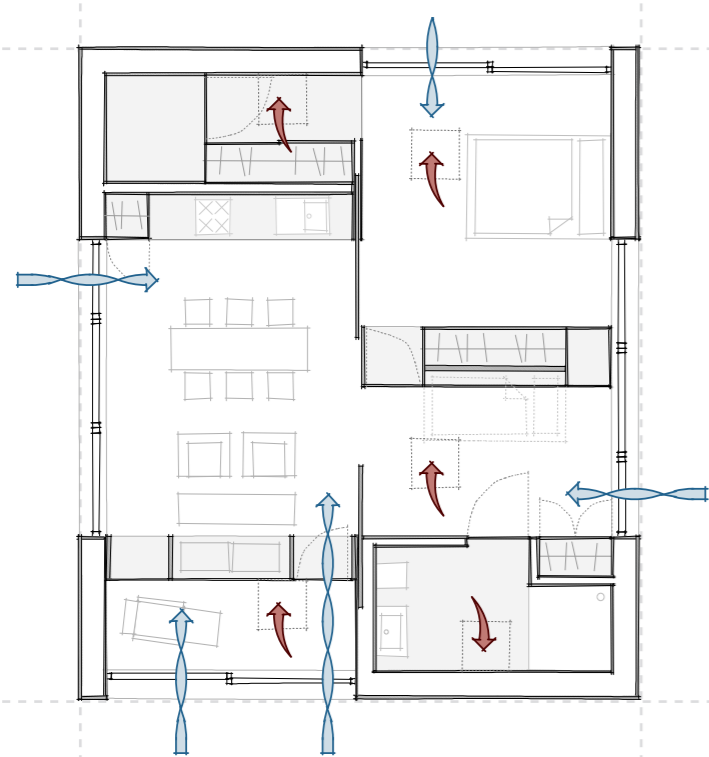

From the west to east side, the house is cross ventilated by opening the windows. On the south part, we have skylight in the sunspace. Skylights release hot air rising through the roof.

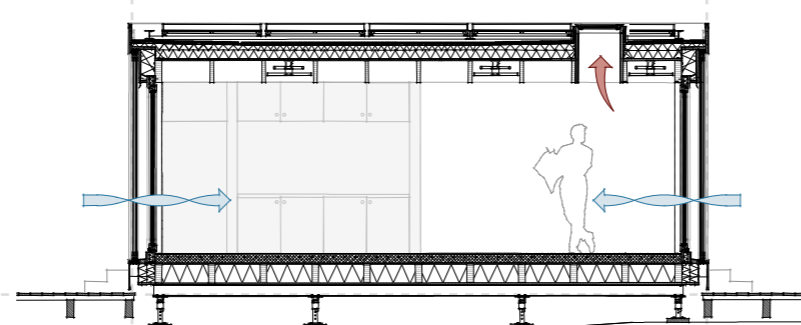

SUN SPACE

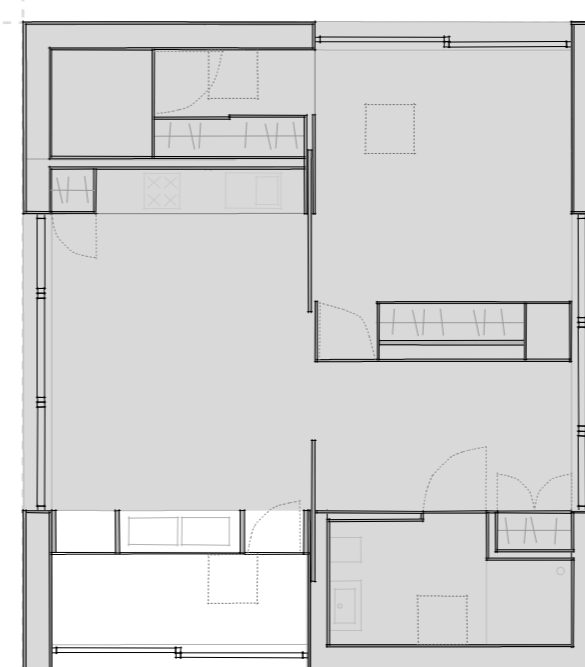

The house have a flexible sunspace to the south that can prolong the outdoor season, by providing a generally higher temperature that varies with the seasons.

It can also contract and make way for a bigger living room when the sunspace is not needed.

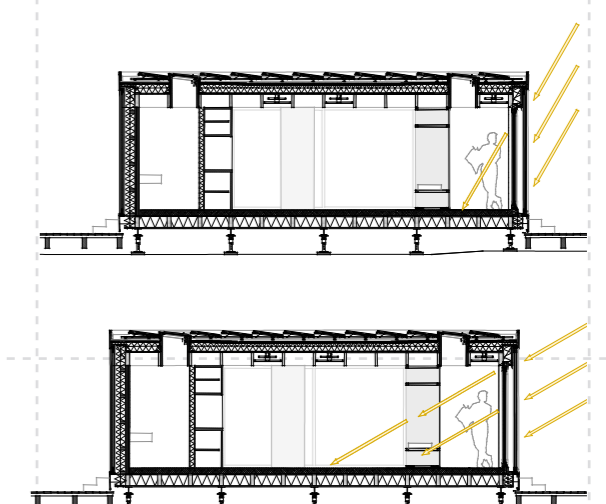

ACTIVE SOLAR PV

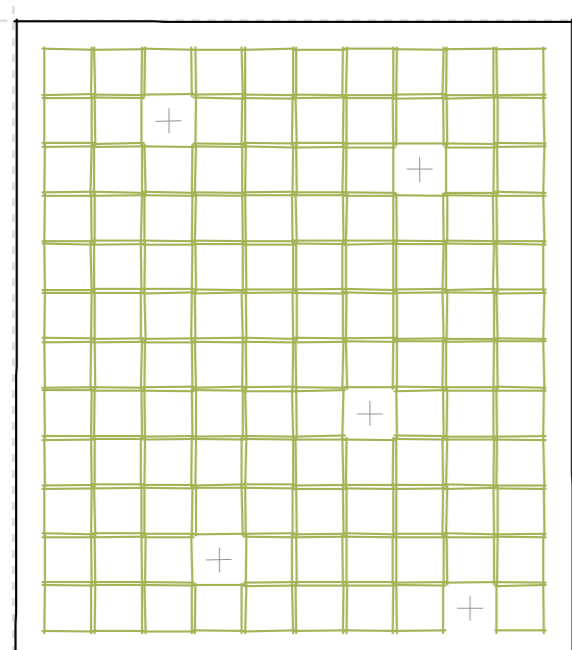

By calculating in PVGIS, we see that the optimize inclination in Trondheim, Norway is 43° and for Madrid Spain is 34°.

But since the competition is in June, we must optimize the angle for this month only. In Madrid in June, when the inclination is 34°, the average monthly electricity production from the PV is 144kWh. If changing the inclination into 10°, the average electricity production in June will be 165kWh. So the inclination of 10° has been chosen in this case.

The 635x541x30mm polycrystalline solar panels provide maximum production of 45W.

SOLAR SHADING

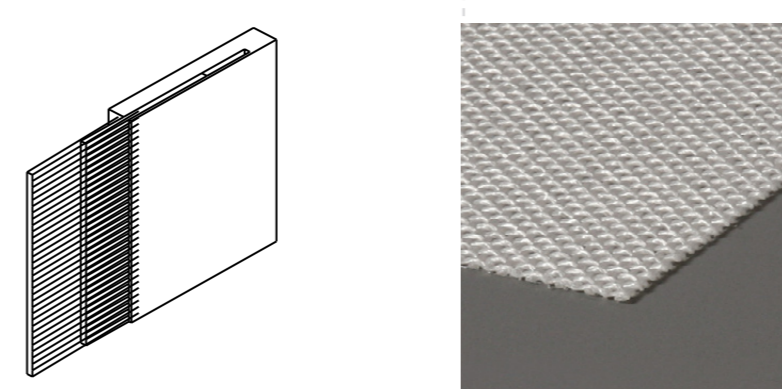

This polyester shading layer is used in the day time. The material itself is light, and its semi-transparent nature gives the possibility to look out from the interior of the house, but blocking view from the exterior and into the house. Another advantage is that it allows the wind to pass through while working as shading device. It is cheap and easy to operate and maintain.

ACTIVE COOLING/HEATING

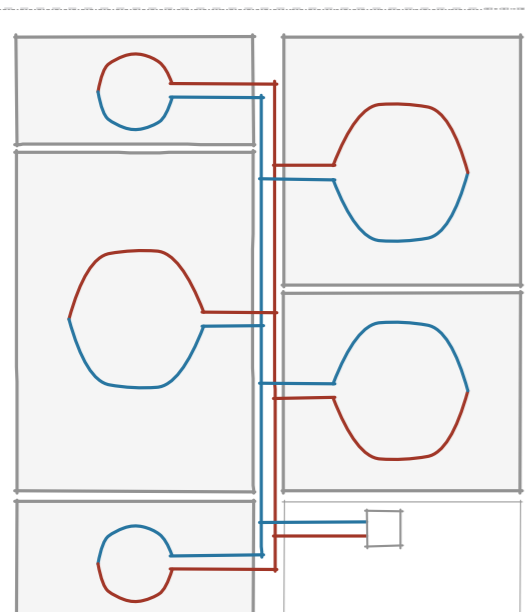

A core-activated concrete slab provide low temperature radiant heat in the winter, and can work as a cold water heat sink in the summer.

Separating the deck into zones gives the possibility of differentiating between functions and uses. The bedrooms can hold a lower temperature than the livingroom and kitchen for instance.

NIGHT INSULATION

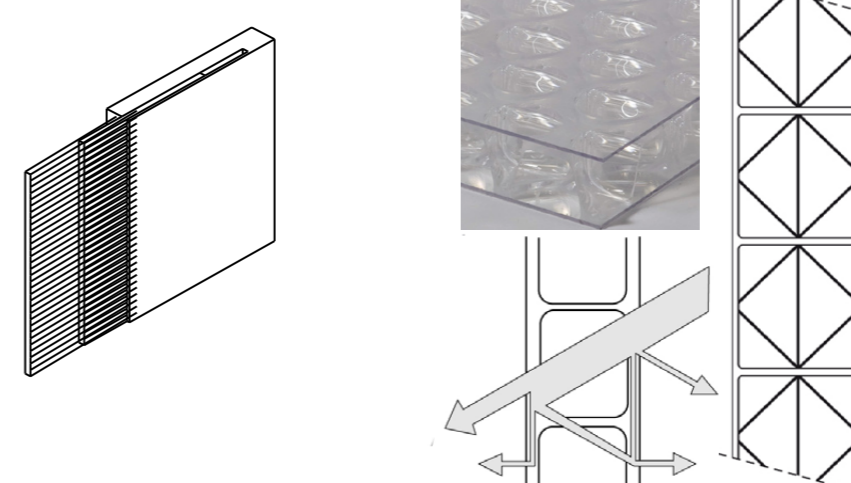

Lexan thermalclear is used as an insulation layer. It is material with transparency between 82% and 38% with U=1,8 W/m2K, acoustic 23dB. During the night, when the temperature is decreasing, we have the choice to close this layer working as insulation.

DIFFERENT SCENARIOS

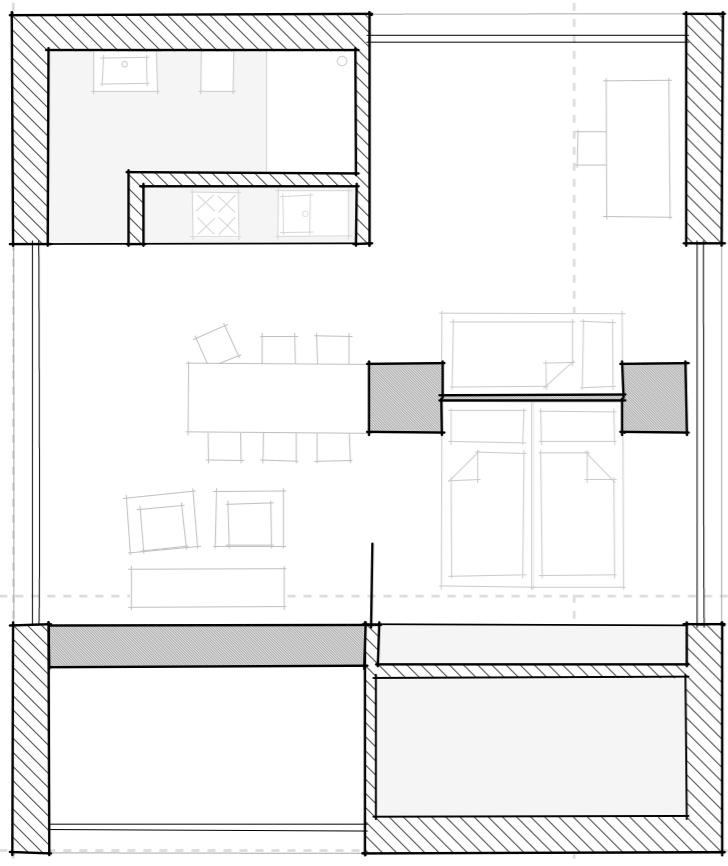

For a family of four.

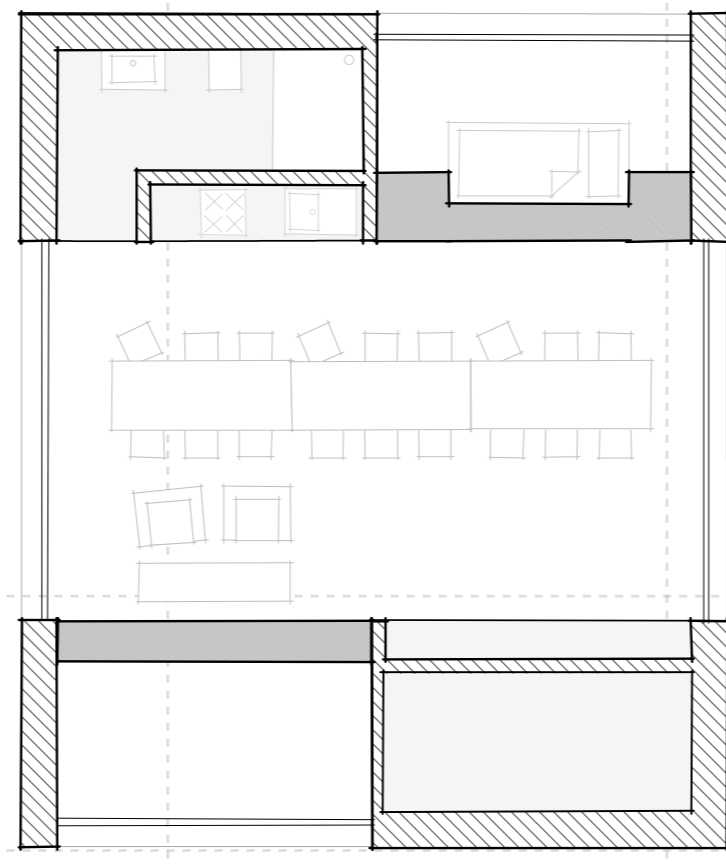

For a party of ten.

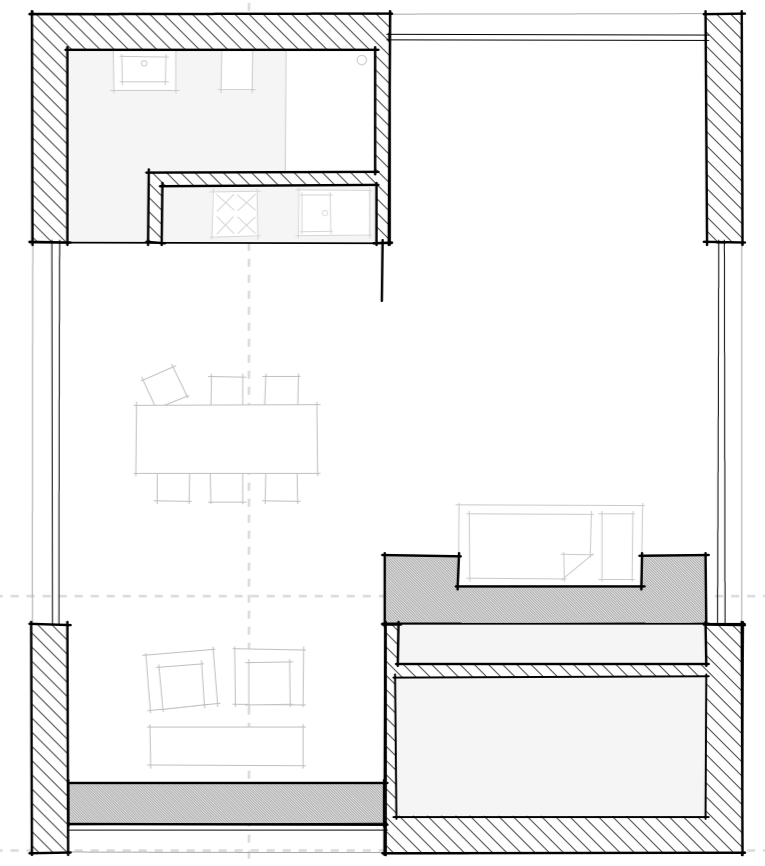

Studio apartment for an artist?

DETAILS 1:20

- 1 FLOOR PLAN SUN SPACE
- 2 FLOOR PLAN SUN SPACE
- 3 SECTION ROOF
- 4 SECTION FLOOR

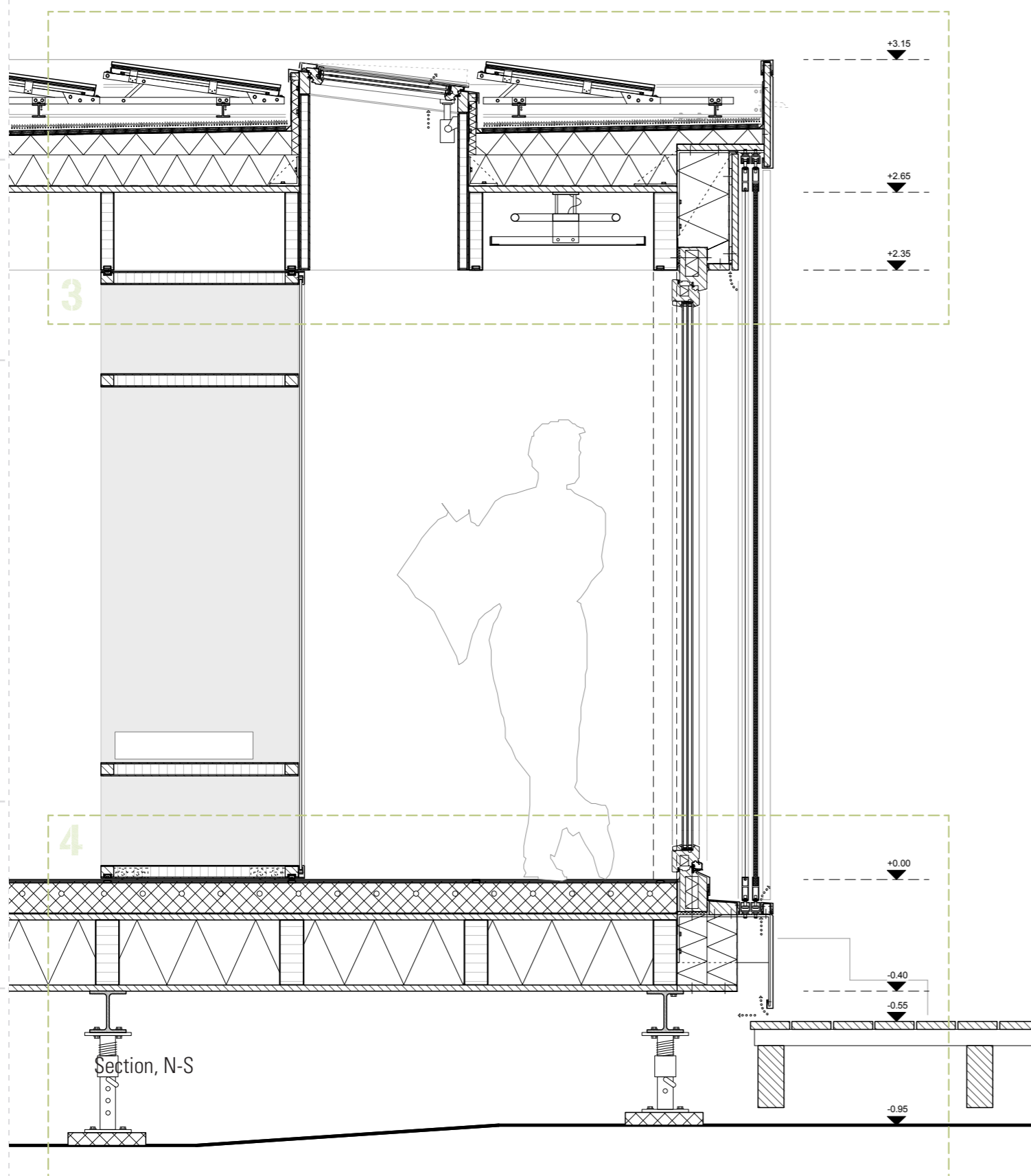
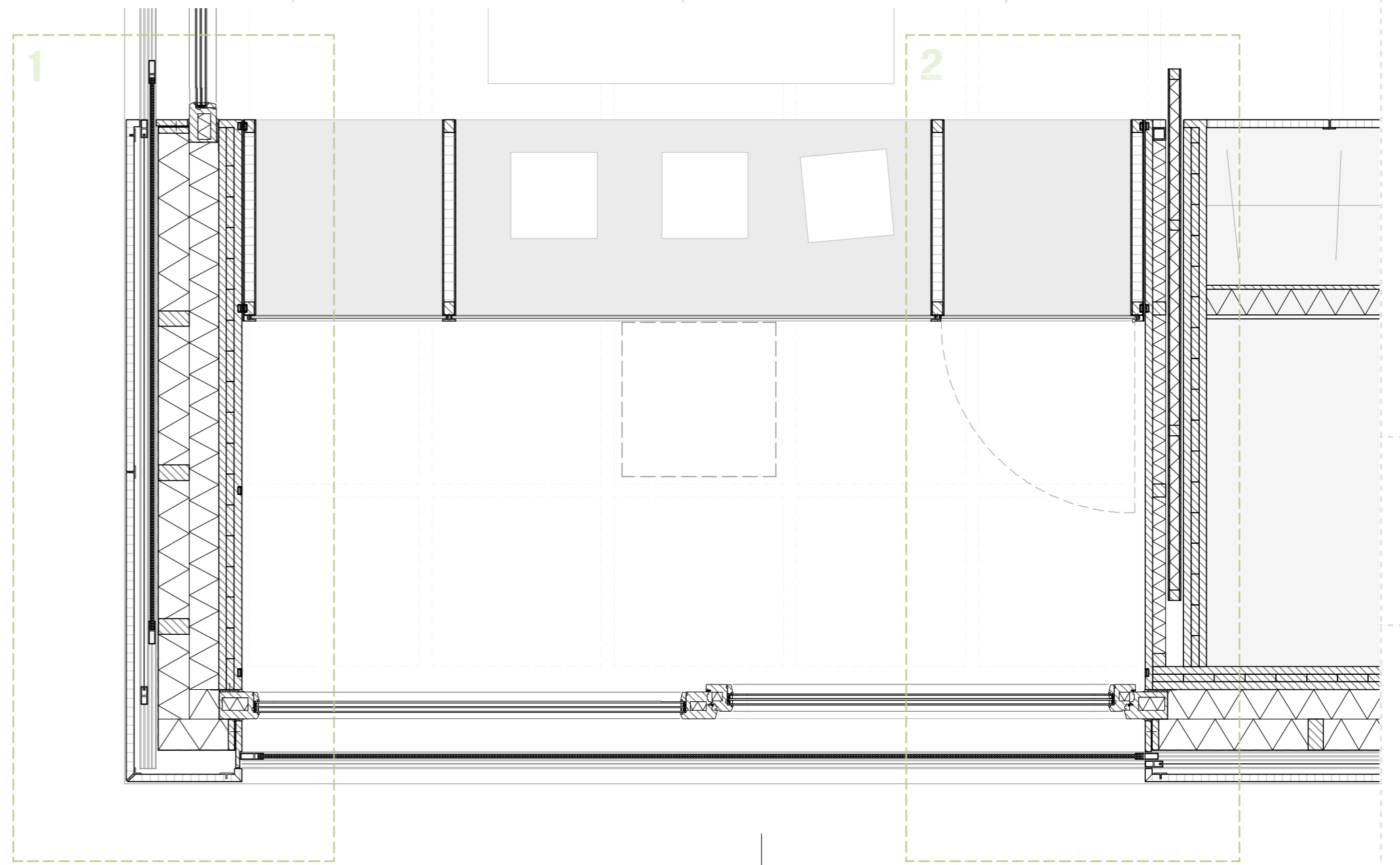

FLOOR PLAN SUN SPACE 1:5

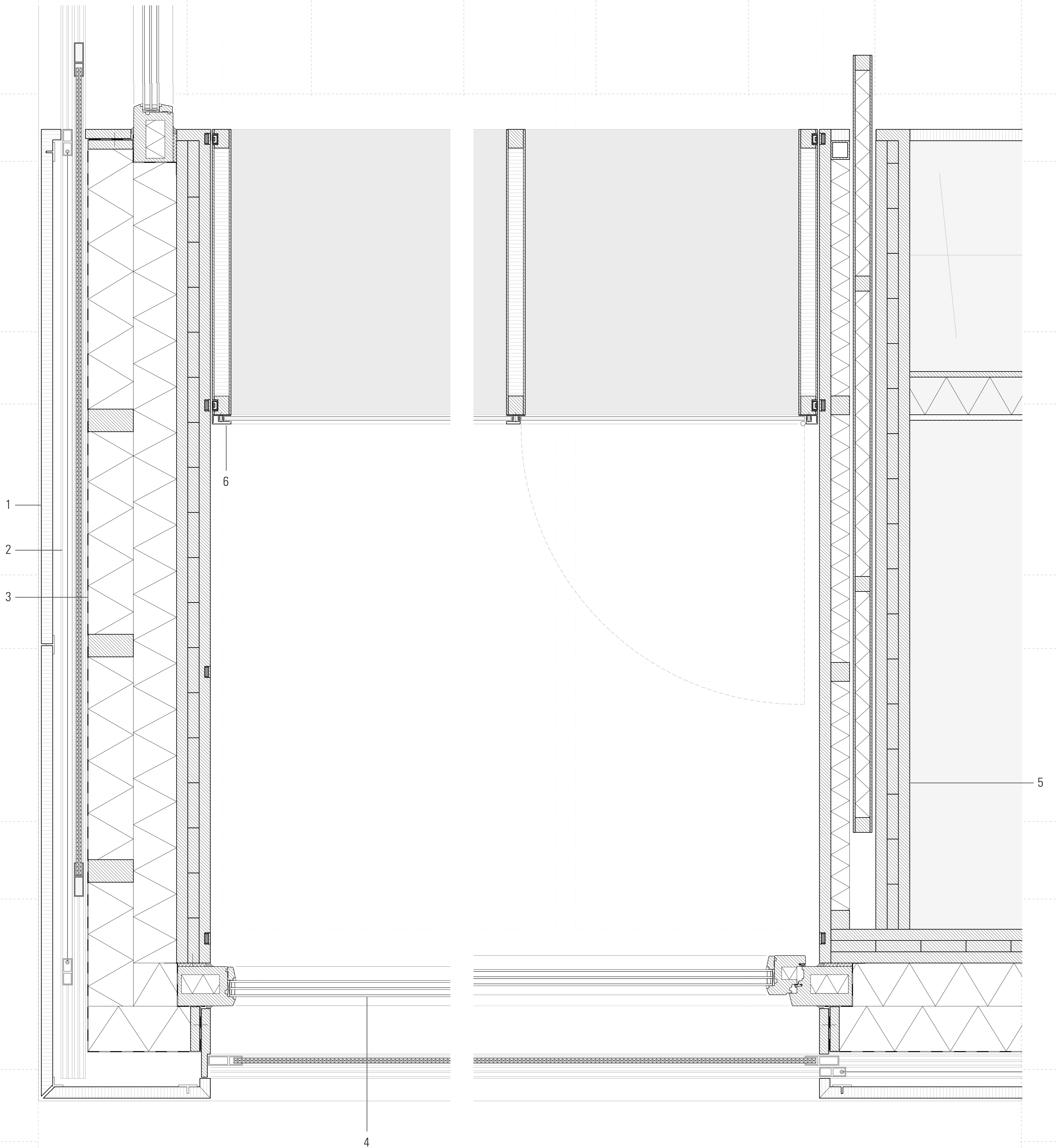

1 Wooden cladding:
600x300mm oak boarding connected by steel profiles on the backside

2 Sliding layers:
20mm polyester shading layer
24mm Lexan Thermalclear: transparency between 82% and 38% with U=1,8 W/m²K, acoustic 23dB

3 External wall construction:
Vapour barrier
2x120mm polystyrene insulation filled in between the vertical direction wooden studs (@ 500mm c/c)
90mm massive wooden wall

4 Wooden framed triple-glazed window with U=0,61 W/m²K (Energate 1042+)

5 Internal wall:
20x300mm massive wood fixed by steel profiles on the backside
30mm air gap for fitting the sliding wall
40mm polystyrene insulation filled in between wooden studs (@ 500mm c/c)
One layer of plasterboard

6 Moveable box:
Wooden framework
One layer of glass
Magnetic seals (@ 200mm c/c) for having separated thermal zones between sunspace and living room

SECTION ROOF_FLOOR 1:5

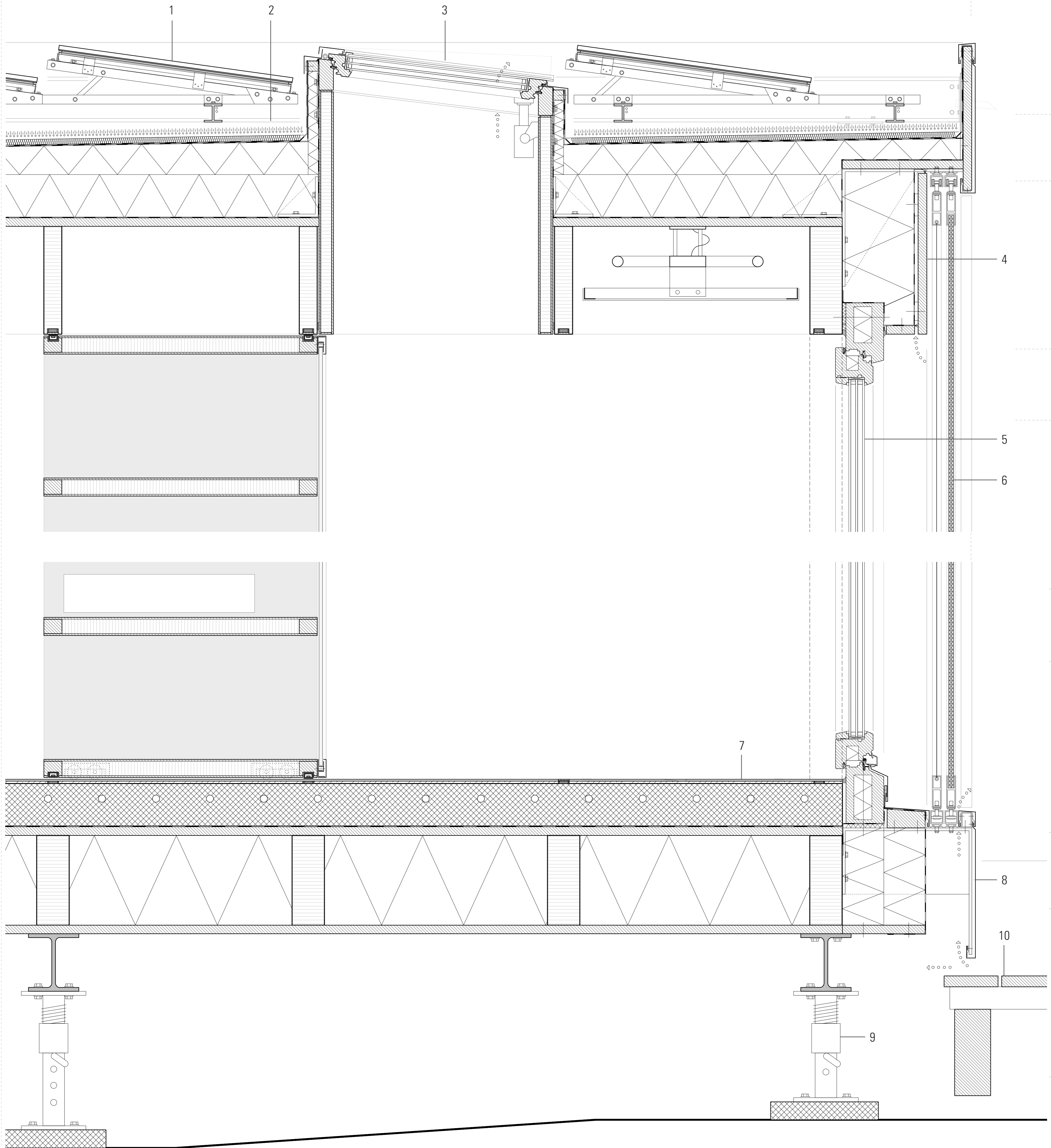

1 PV Panels:
635x541x30mm polycrystalline solar panels
PV panels supporting profile (galvanized steel)
46x80x3.8mm IPE profile

2 Roof construction: U=0.13 W/m²K
50mm bed of gravel
50mm fibre mat
Two layers of bitumen felt
Wedge shaped insulation (Expanded polystyrene)
200mm expanded polystyrene insulation fix mechanical
Vapour barrier (DPM)

24mm three-ply panel punched to the roof rafters
60x240mm glue laminated beams

3 500x500mm opening Skylight, Wooden framed triple-glazed window, U=0.61 W/m²K

4 Battlement: Zink cap cover
300mm Massive wood
Hot-dip galvanized console connected to the massive wood structure (@ 600mm c/c)
240mm expanded polystyrene insulation

5 Wooden framed triple-glazed window with U=0.61 W/m²K (Energate 1042+)

6 Sliding layers:
20mm polyester shading layer
24mm Lexan Thermalclear: transparency between 82% and 38% with U=1.8 W/m²K, acoustic 23dB

7 Floor construction:
3,2mm Linoleum
20 mm equalization layer

PE-film
120mm concrete core activation (Ø20mm @ 150mm)
PE-film
24mm OSB
90x 240mm Norwegian pine wooden beams structure (@ 600mm c/c) fill with 240mm Rockwool (U=0.5 W/m²K) in between
24mm celit 3D (vapour open)

8 Zink cap cover
Hot-dip galvanized console connected to the massive

wood structure (@ 600mm c/c)
Vapour barrier (DPM)
240mm expanded polystyrene insulation
24mm OSB

9 Foundation:
HEB120
500x100mm steel posts
400x400x20mm steel sole plate

10 Outdoor terrace with wooden surface