Inside Out House

Detail.

Nigar Zeynalova, Michael Gruner, Ivan Kalc, Isabelle Davoult and Thea Foss

Solar Chimney

Heat Recovery system

Double facade / heat collectors

Floor Structure / Air Intake

Detail.

The following work is done between 01.10.2010 and 31.10.2010 based on the previous work modules 1st Concept and 2nd Concept. Our concept was named Inside Out House after our intentions of making the house that expands outside when the weather allows it. The main idea was to have the living space opened to the outside as much as possible. This was achieved by large glazing areas, with several strategies applied to keep it energy efficient at the same time. All the systems used are shown in detail in the following pages and they include glazing facade with a third layer of solar shading, a heat recovery system and air movement through stack effect. After the 2nd Concept we had some doubts about how effective a double layer facade would actually work, but we were advised to follow our first intentions and try to draw it in detail. We have tried to follow the rules for the competition when working on the details. We have also aimed to make the details efficient for both Trondheim and Madrid. If this came in conflict with reasonable solutions or each other, we have tried to make alternative details.



The Inside Out House.

The last rendering of the house made in the 2nd Concept module.

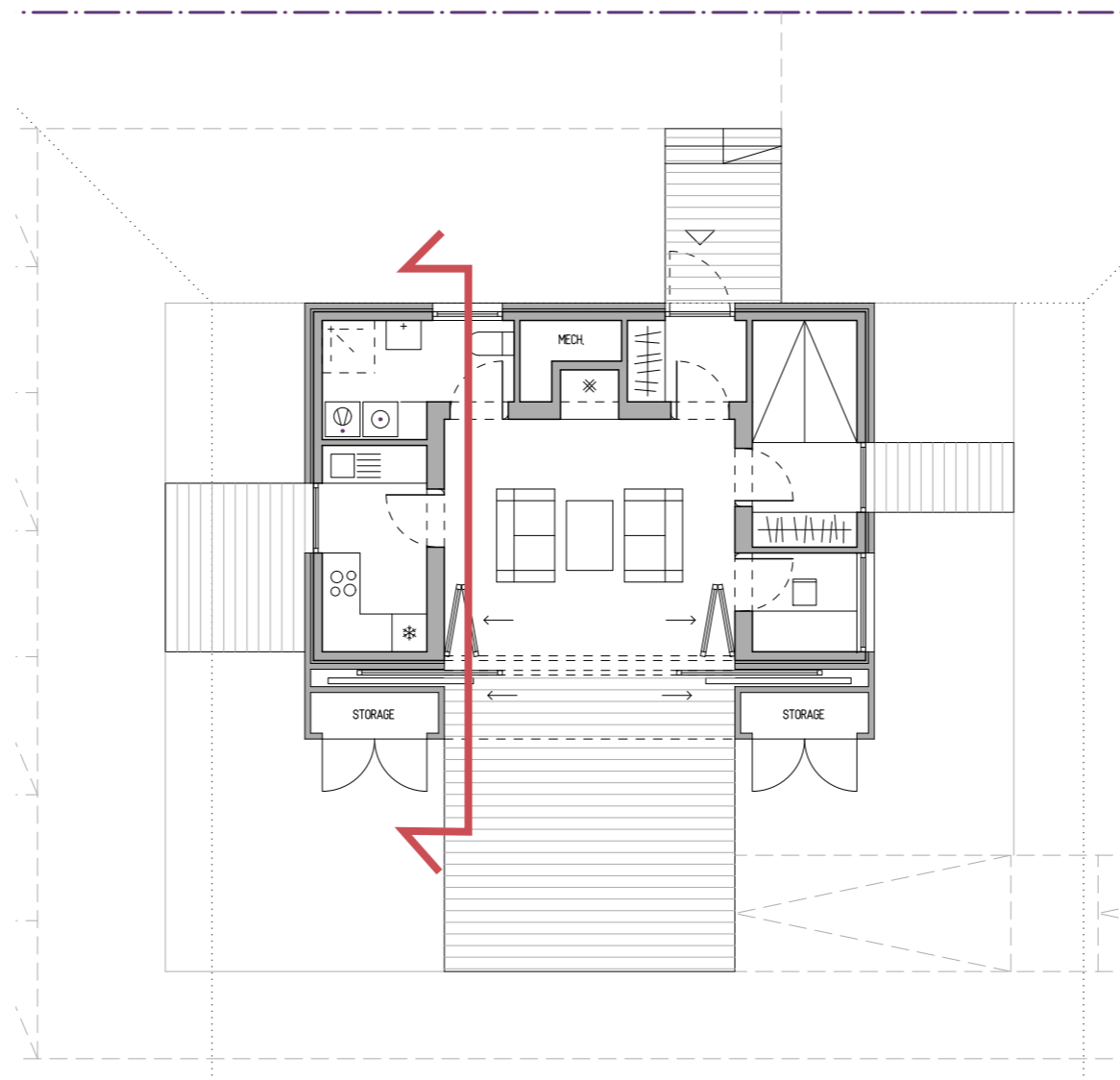

The section.

Our detail is drawn as one section, cutting all our focus points.

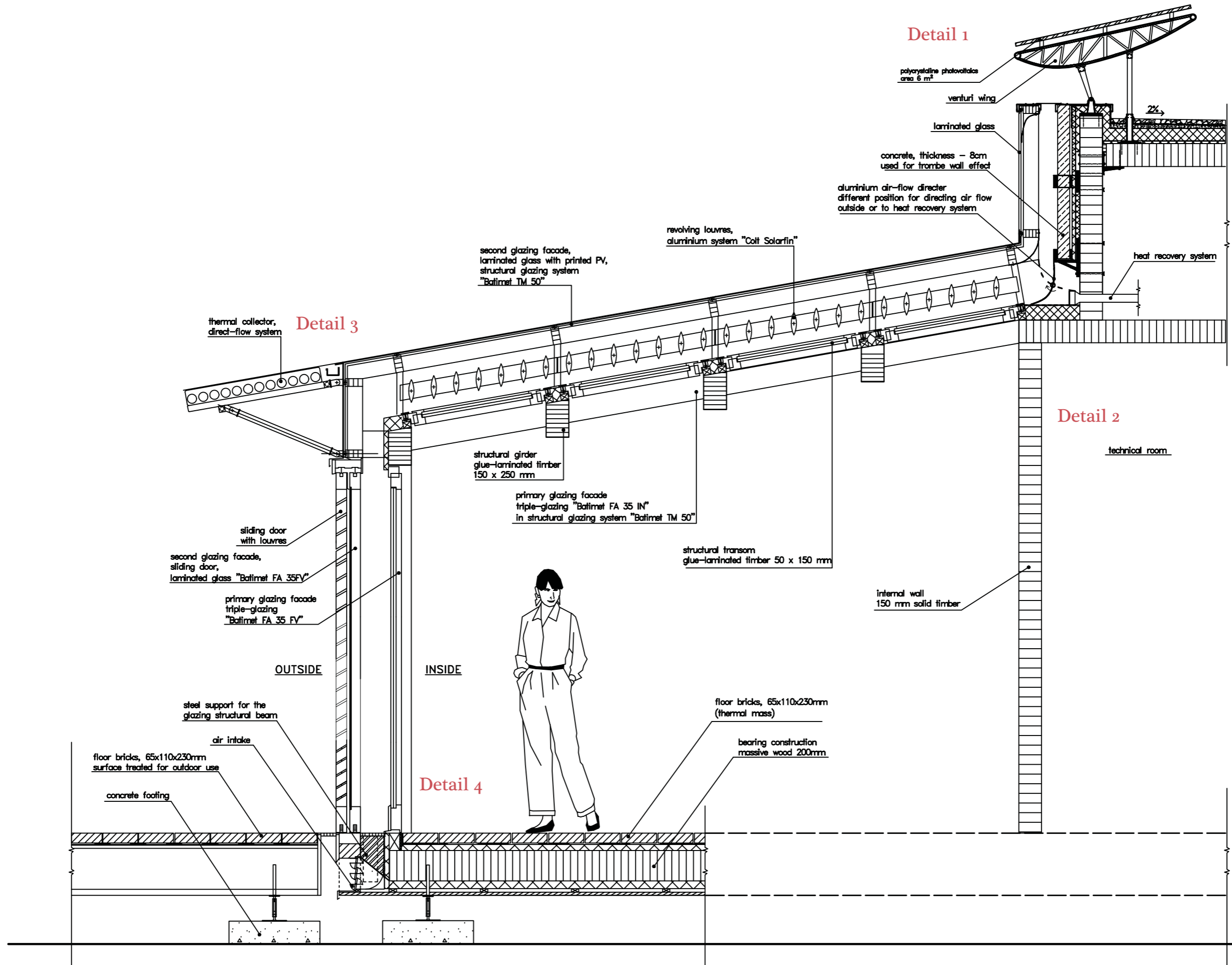

The Cross Section

Details.

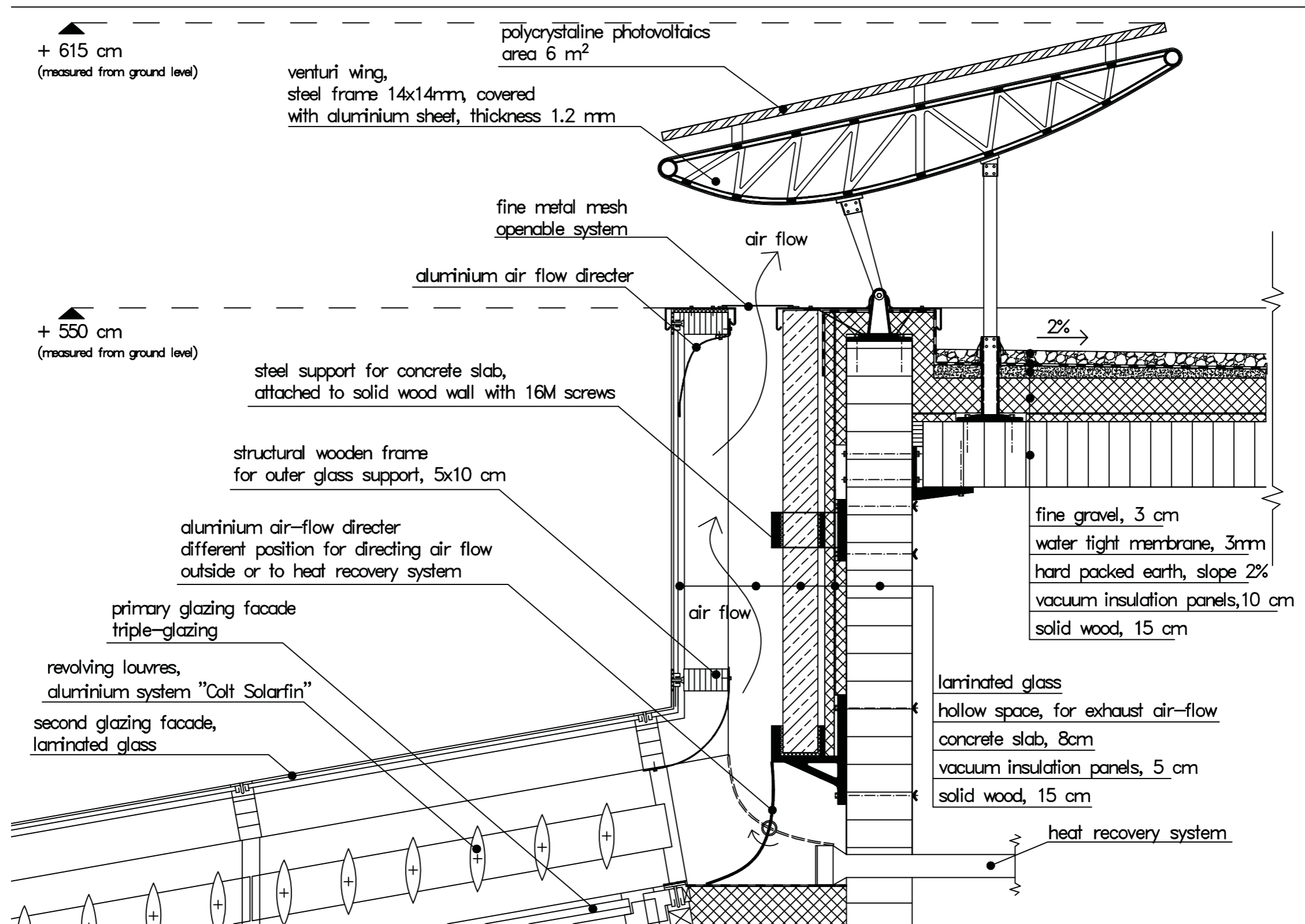

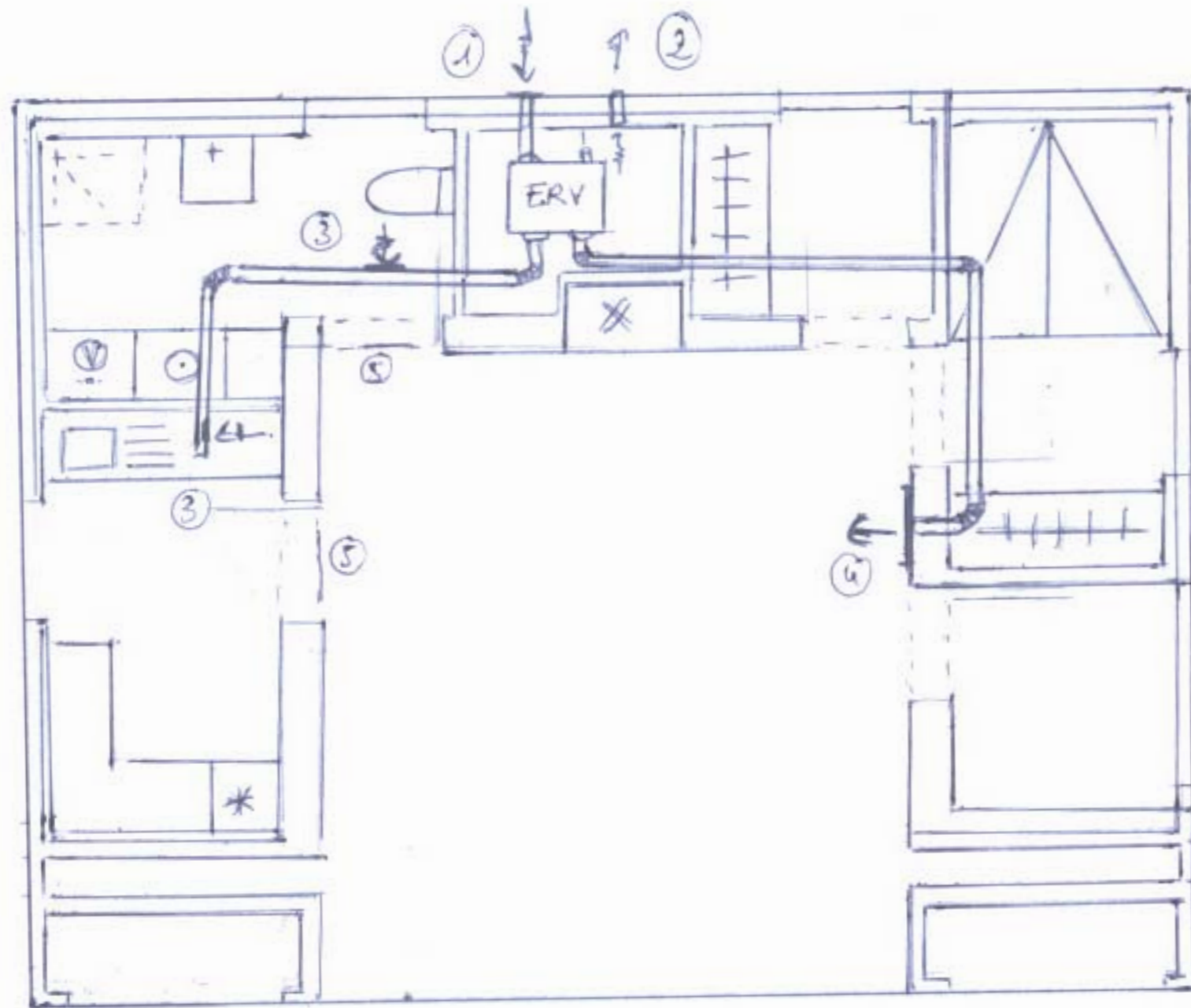

- ① OUTDOOR SUPPLY GR
- ② EXHAUST GRID
- ③ RETURN GRID
- ④ INDOOR SUPPLY GRID
- ⑤ DOOR OPENINGS

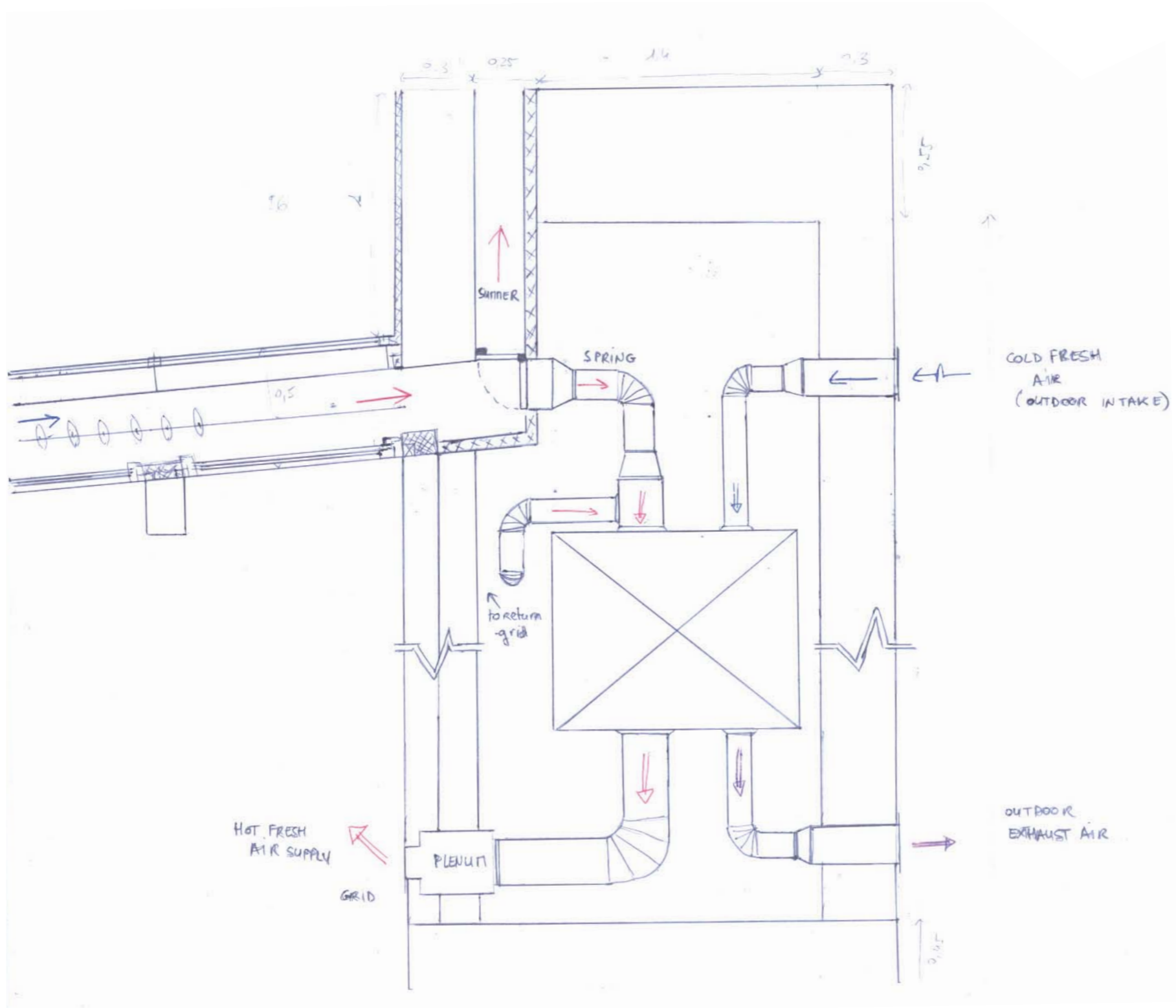

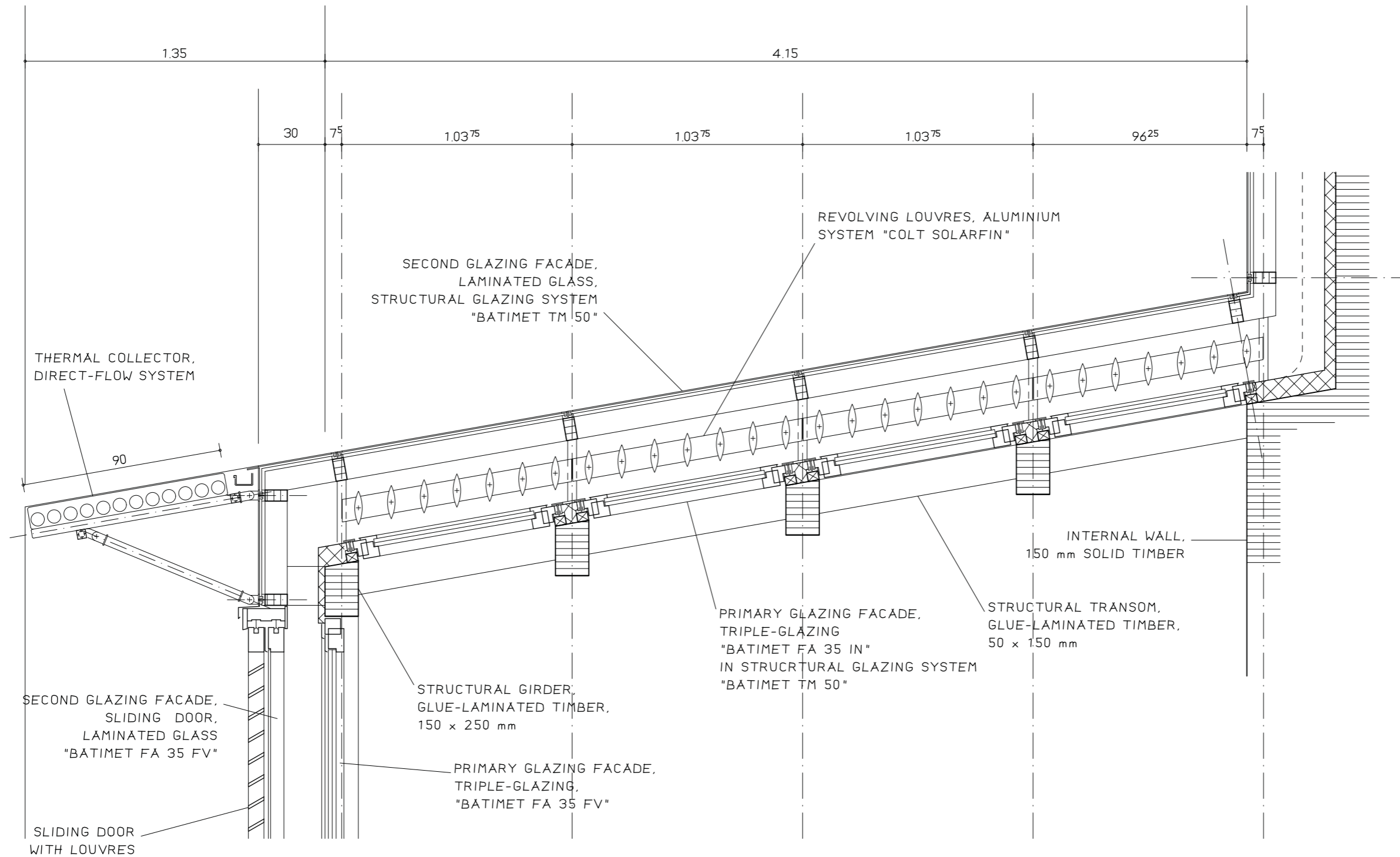

Detail 3: Double facade / heat collectors

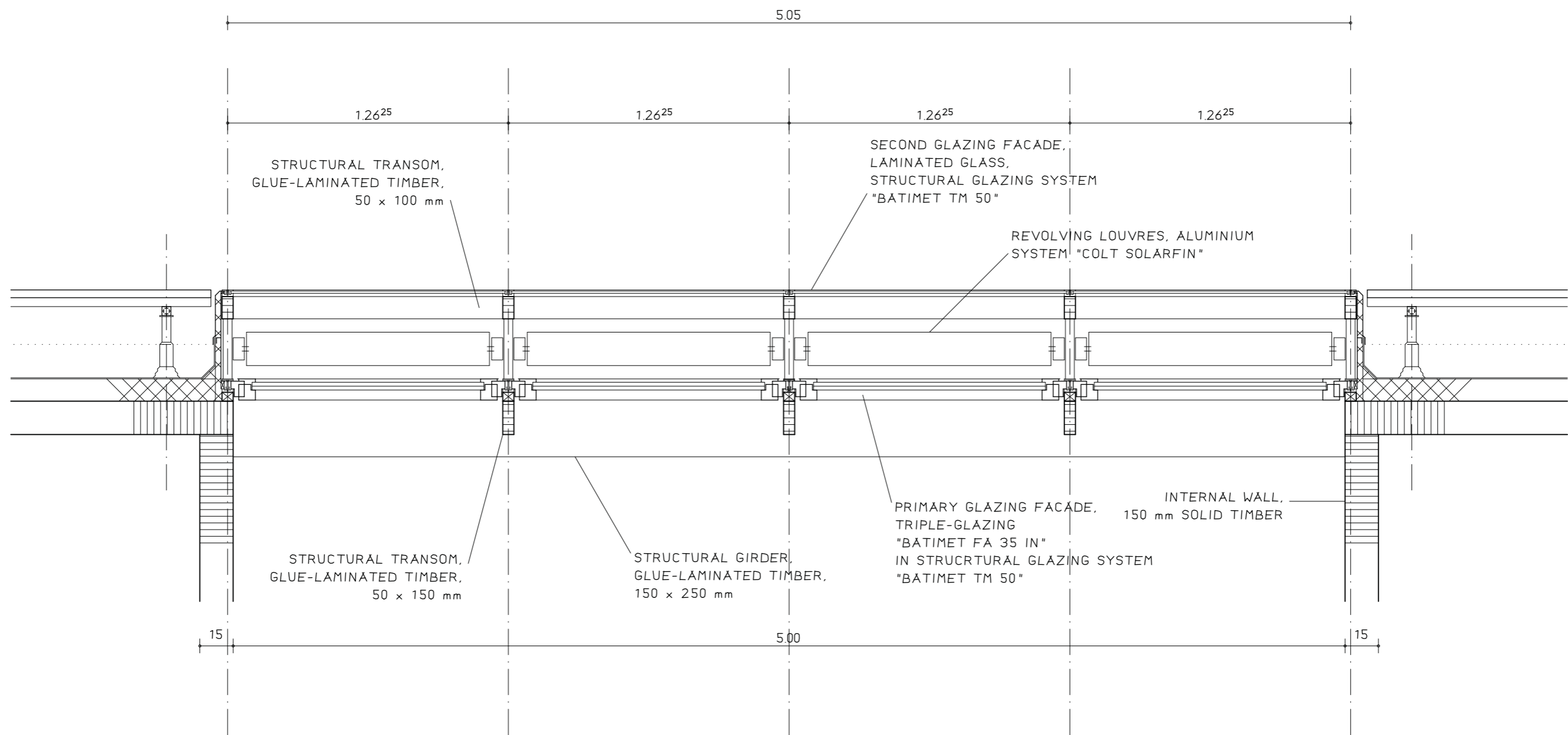

Glazing Roof Longitudinal section

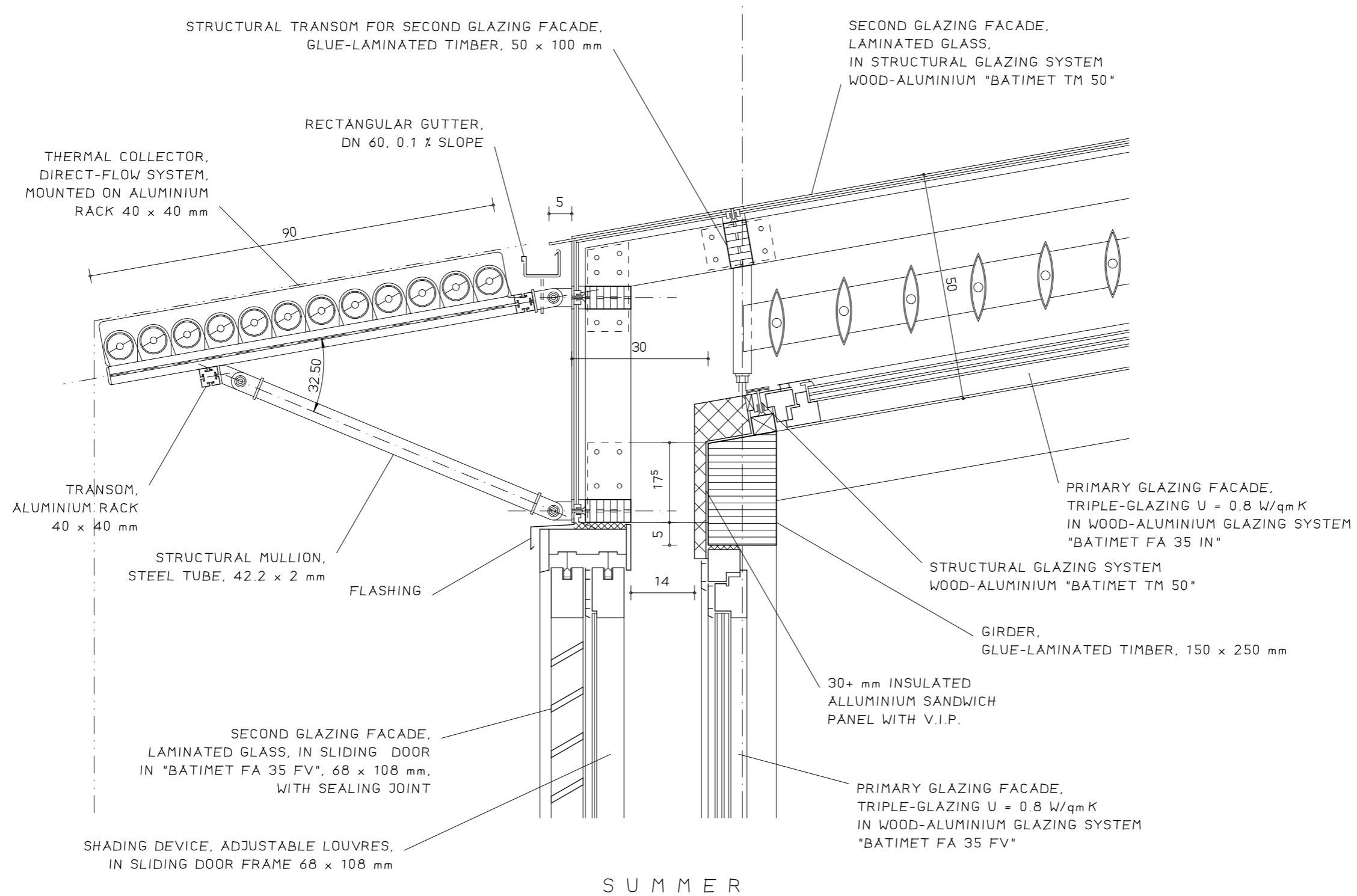

Detail 3: Double facade / heat collectors

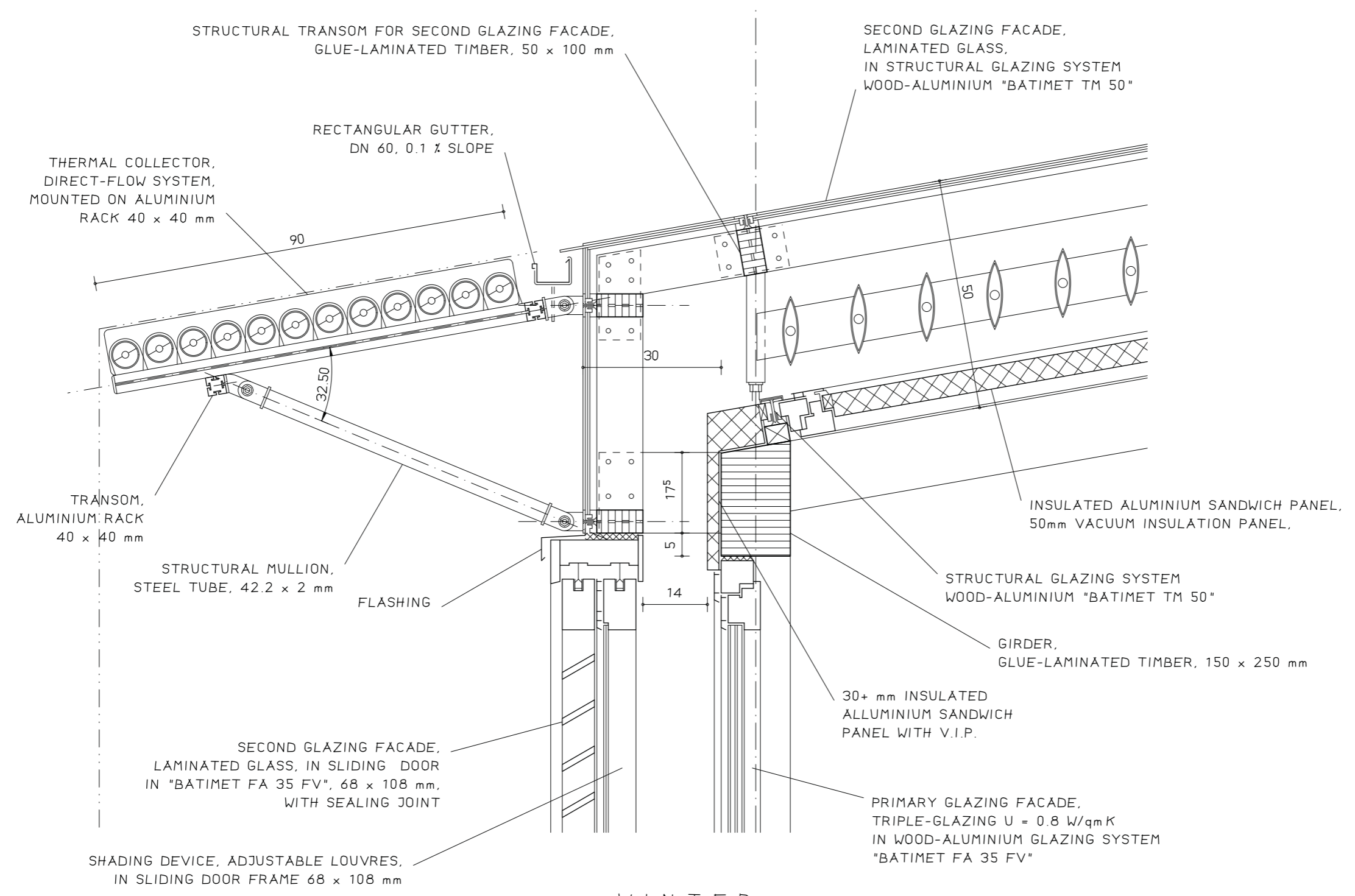

W I N T E R

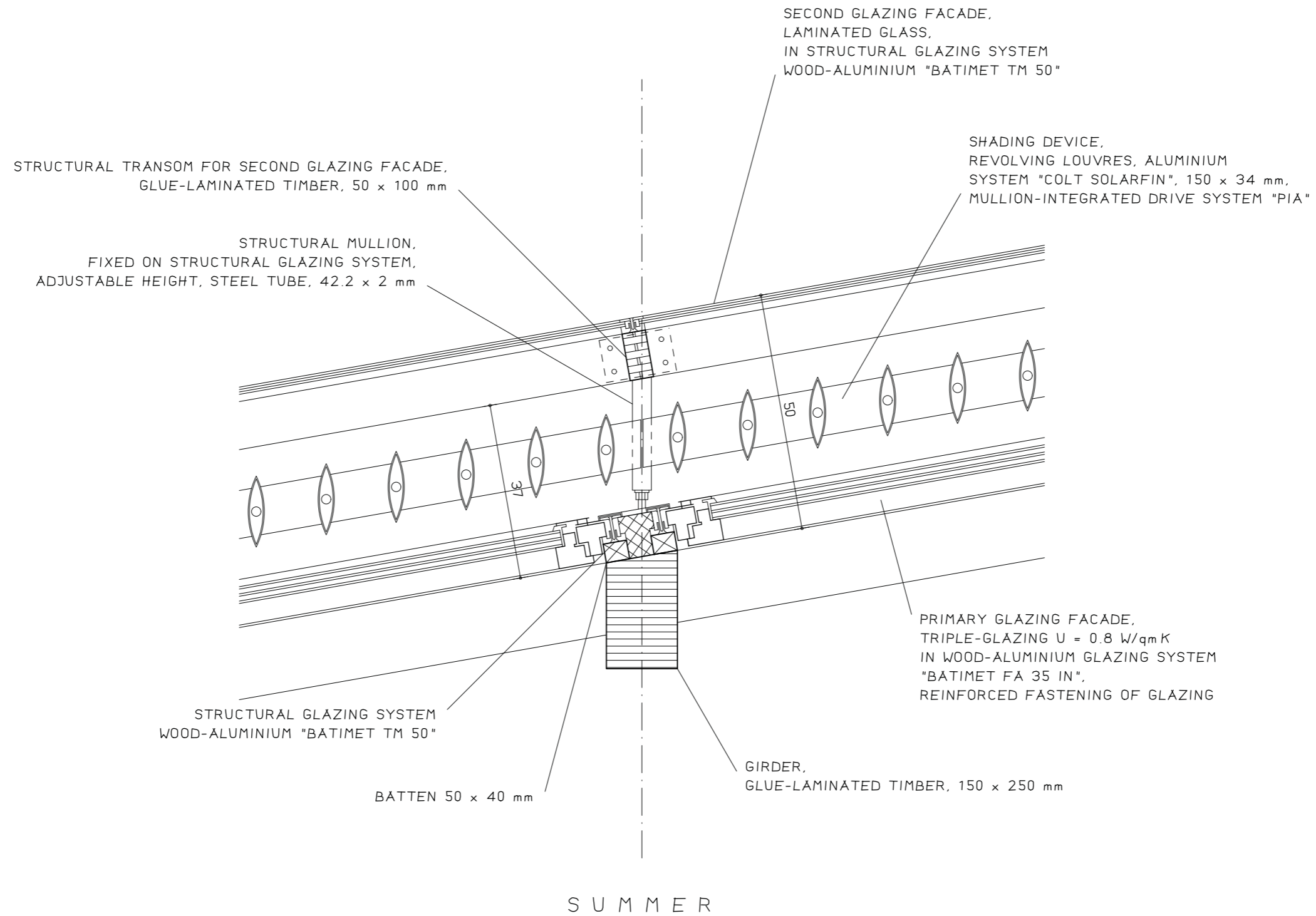

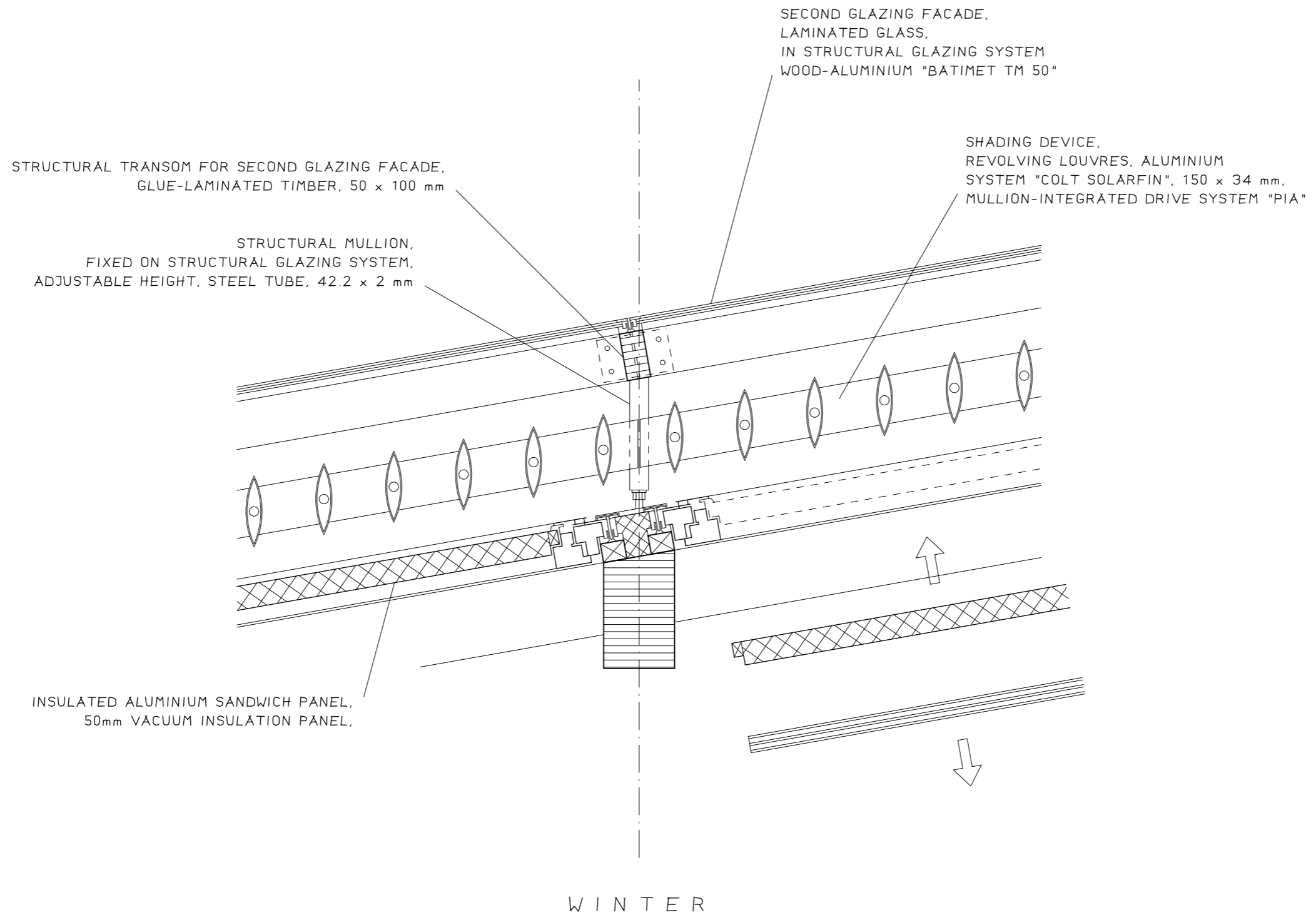

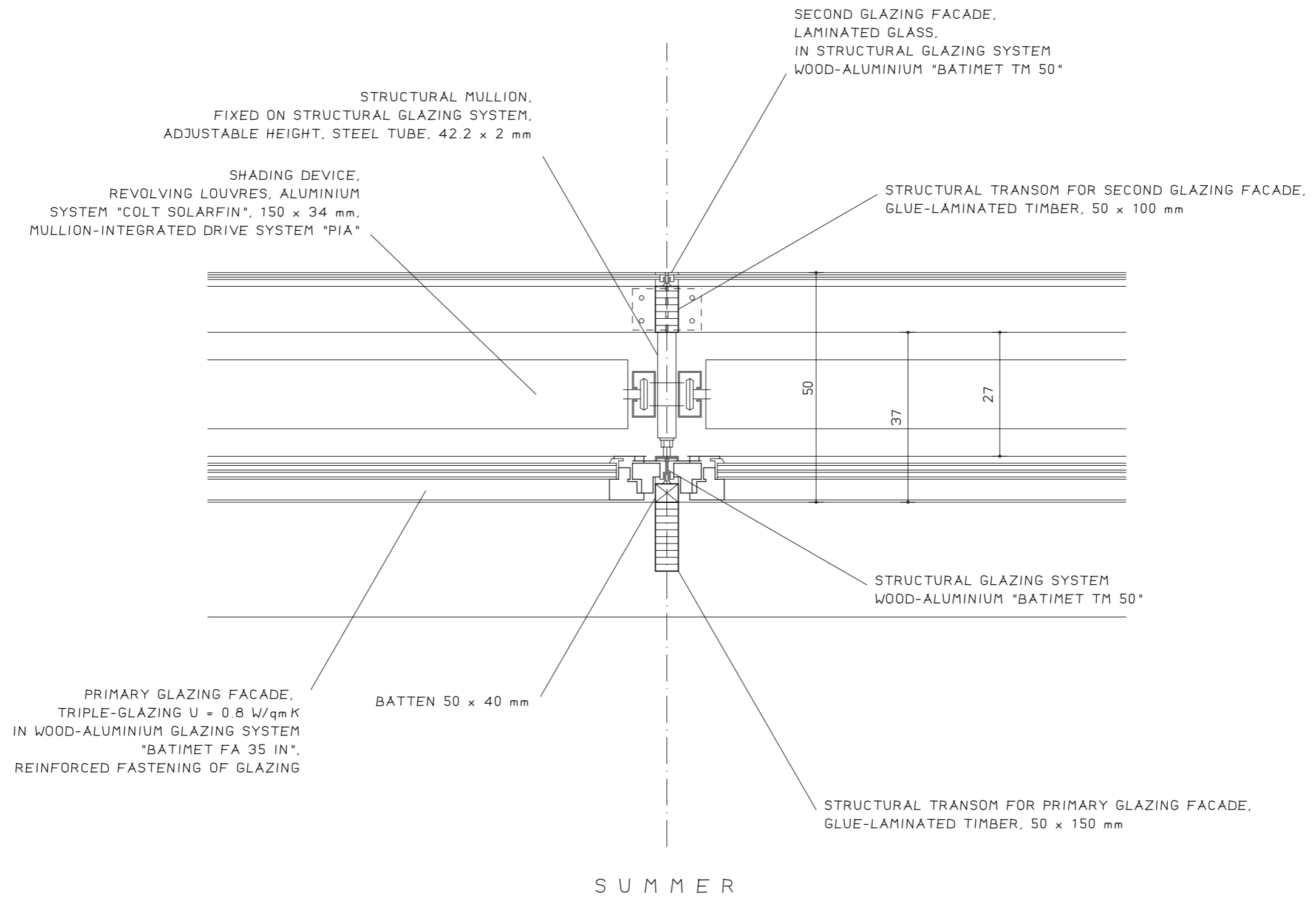

Detail 3: Double facade / heat collectors

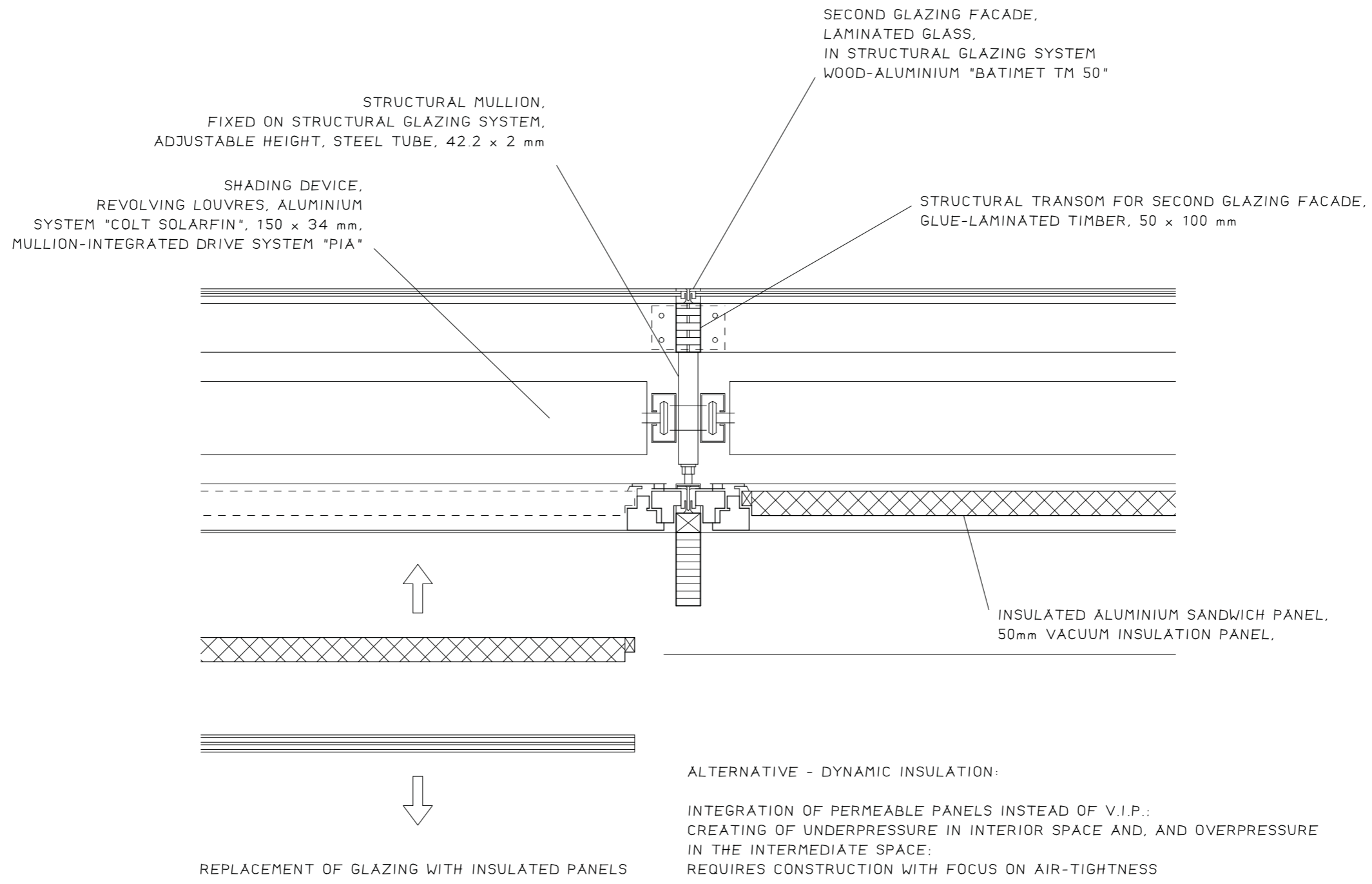

W I N T E R

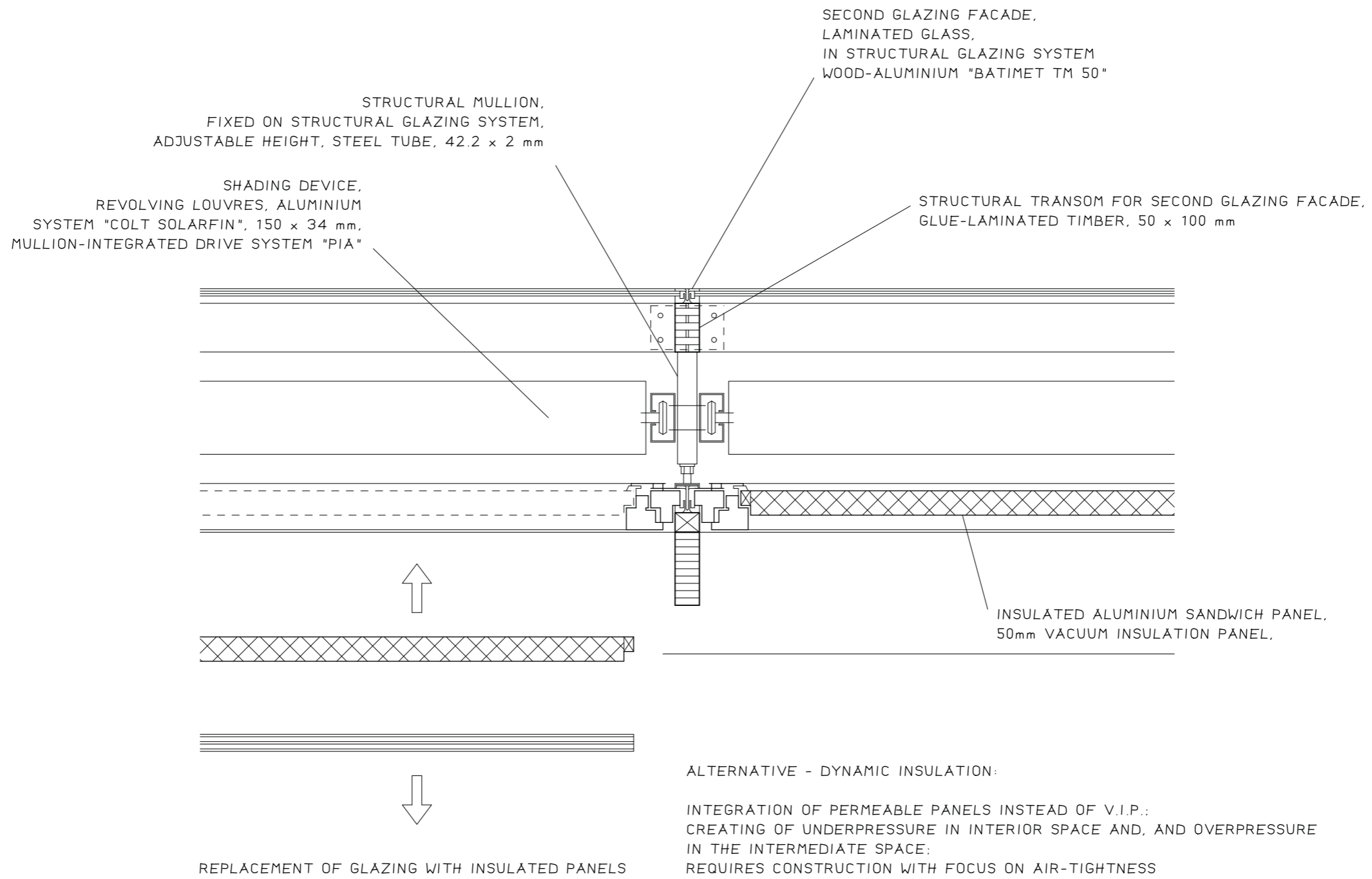

W I N T E R

Detail 3: Double facade / heat collectors

1:10

:10

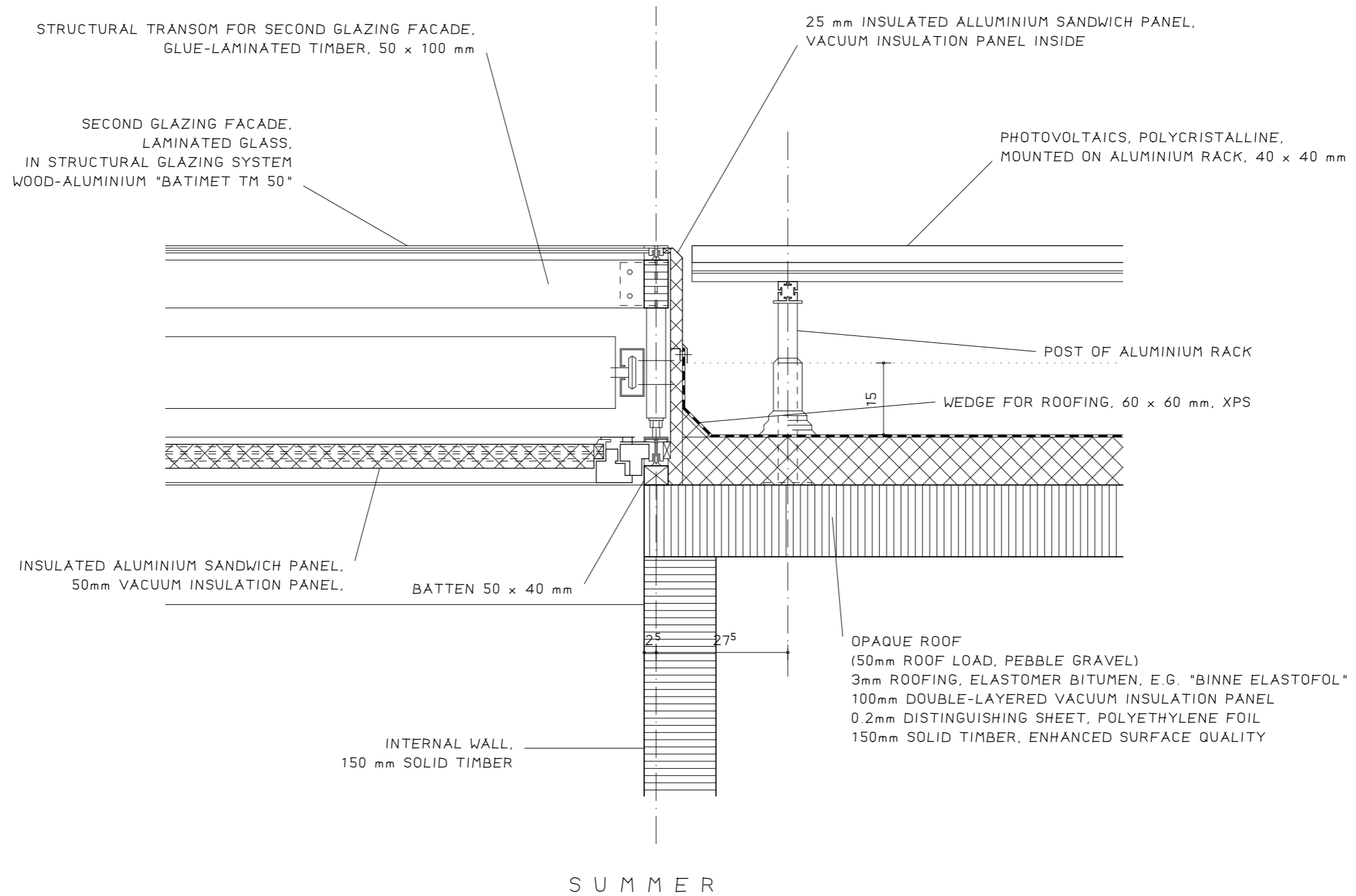

Detail 3: Double facade / heat collectors

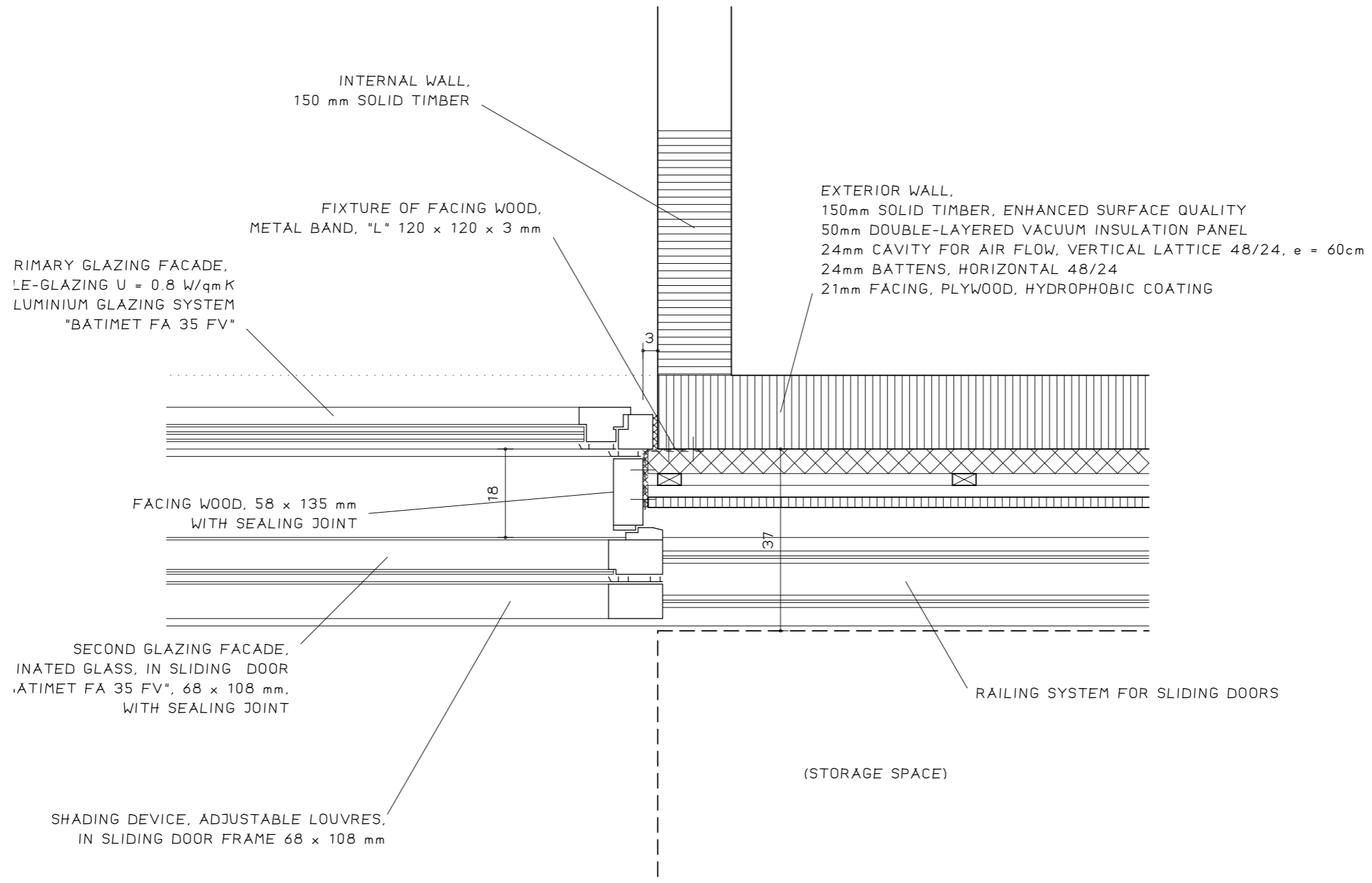

Detail 3: Double facade / heat collectors

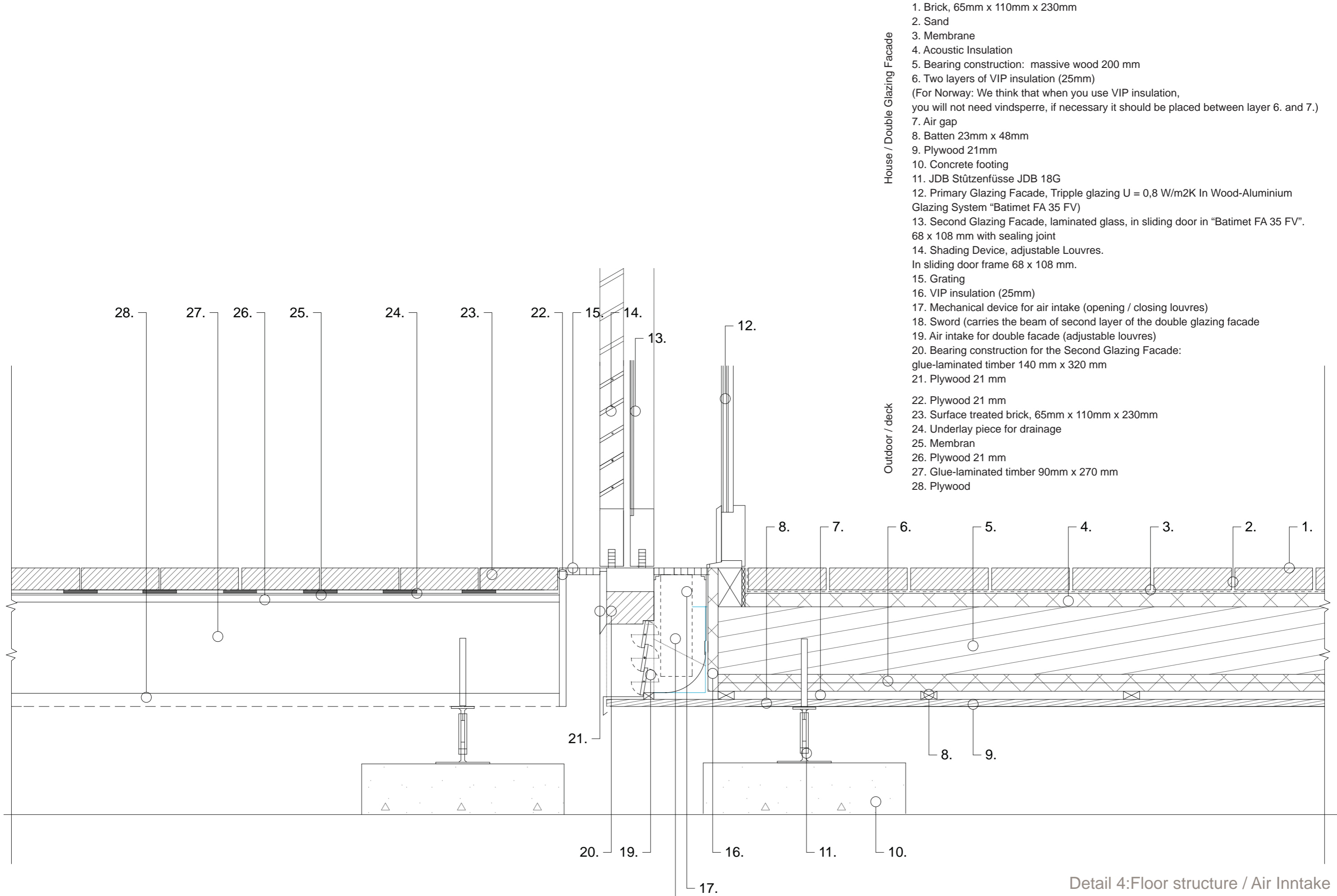

- House / Double Glazing Facade
1. Brick, 65mm x 110mm x 230mm
 2. Sand
 3. Membrane
 4. Acoustic Insulation
 5. Bearing construction: massive wood 200 mm
 6. Two layers of VIP insulation (25mm)
(For Norway: We think that when you use VIP insulation, you will not need vindsperre, if necessary it should be placed between layer 6. and 7.)
 7. Air gap
 8. Batten 23mm x 48mm
 9. Plywood 21mm
 10. Concrete footing
 11. JDB Stützenfüsse JDB 18G
 12. Primary Glazing Facade, Tripple glazing U = 0,8 W/m2K In Wood-Aluminium Glazing System "Batimet FA 35 FV)
 13. Second Glazing Facade, laminated glass, in sliding door in "Batimet FA 35 FV". 68 x 108 mm with sealing joint
 14. Shading Device, adjustable Louvres. In sliding door frame 68 x 108 mm.
 15. Grating
 16. VIP insulation (25mm)
 17. Mechanical device for air intake (opening / closing louvres)
 18. Sword (carries the beam of second layer of the double glazing facade)
 19. Air intake for double facade (adjustable louvres)
 20. Bearing construction for the Second Glazing Facade: glue-laminated timber 140 mm x 320 mm
 21. Plywood 21 mm
- Outdoor / deck
22. Plywood 21 mm
 23. Surface treated brick, 65mm x 110mm x 230mm
 24. Underlay piece for drainage
 25. Membran
 26. Plywood 21 mm
 27. Glue-laminated timber 90mm x 270 mm
 28. Plywood

Detail 4: Floor structure / Air Intake

Air inntake Madrid

In summer and winter air comes from under the building through the mechanically controlled adjustable louvres and to the cavity in the double glazed facade.

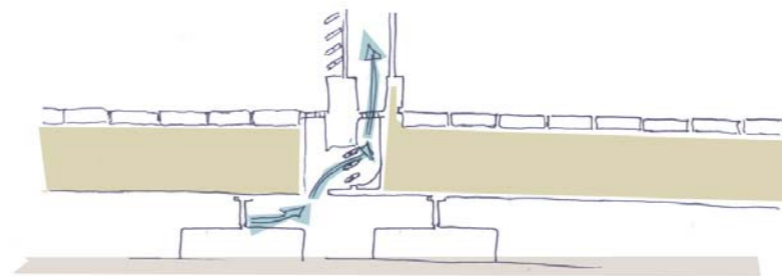

Air intake Trondheim

In winter louvres are closed, there is no air intake as the incoming air is too cold for the system to work properly. In winter the double facade will work as a buffer zone.

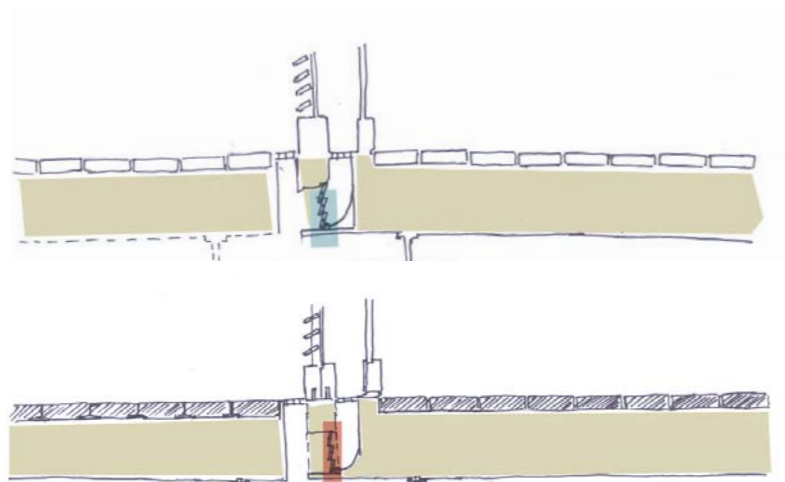

How to make the system work properly in Trondheim?

The alternative is to transport the air for the double facade through pipes below the ground frost level. The ground frost level differs depending on the location.

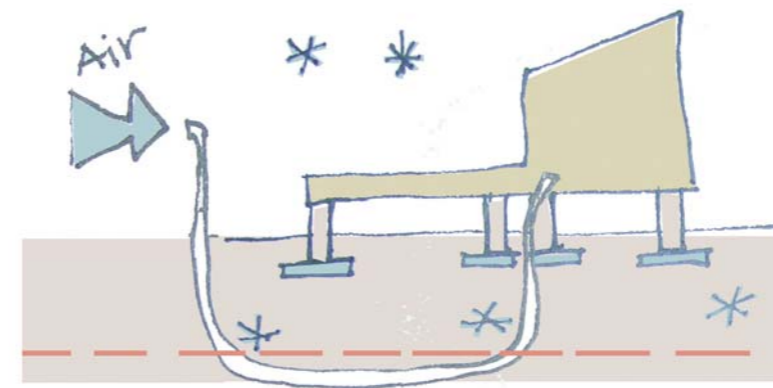

We don't use Concrete as Thermal Mass

Even though concrete makes good thermal mass, the making of concrete is very energy consuming and have negative environmental impact.

We use brick

Instead we use brick, as it makes good thermal mass and is less energy consuming to produce. For the competition we put the brick in sand instead of mortar, so they can easily be reused if the use of building is changed or the building is taken down.

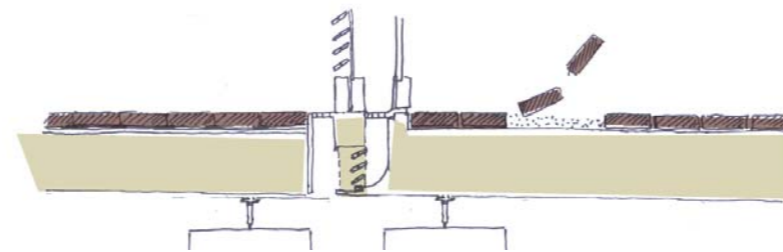

What if the air intake needs to be repaired?

The air intake system can be reached if the grating is removed.

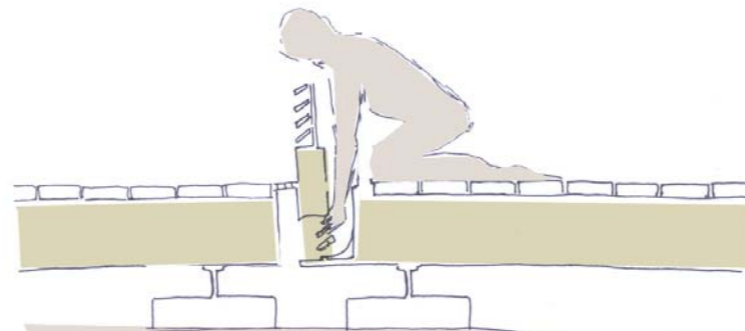

Why have we drawn a wooden deck as an option?

We have bricks on the terrace, because we want to have the same flooring material in the whole living area, both outside and inside. But a wooden deck would be a lot easier to build and maintain, so wood can be an alternative for the bricks.

1. Plywood
2. Glue-laminated timber 90mm x 198 mm
3. Air Gap
4. Wooden beam 48 mm x 148 mm
5. Terrace wooden board 28 mm x 145 mm

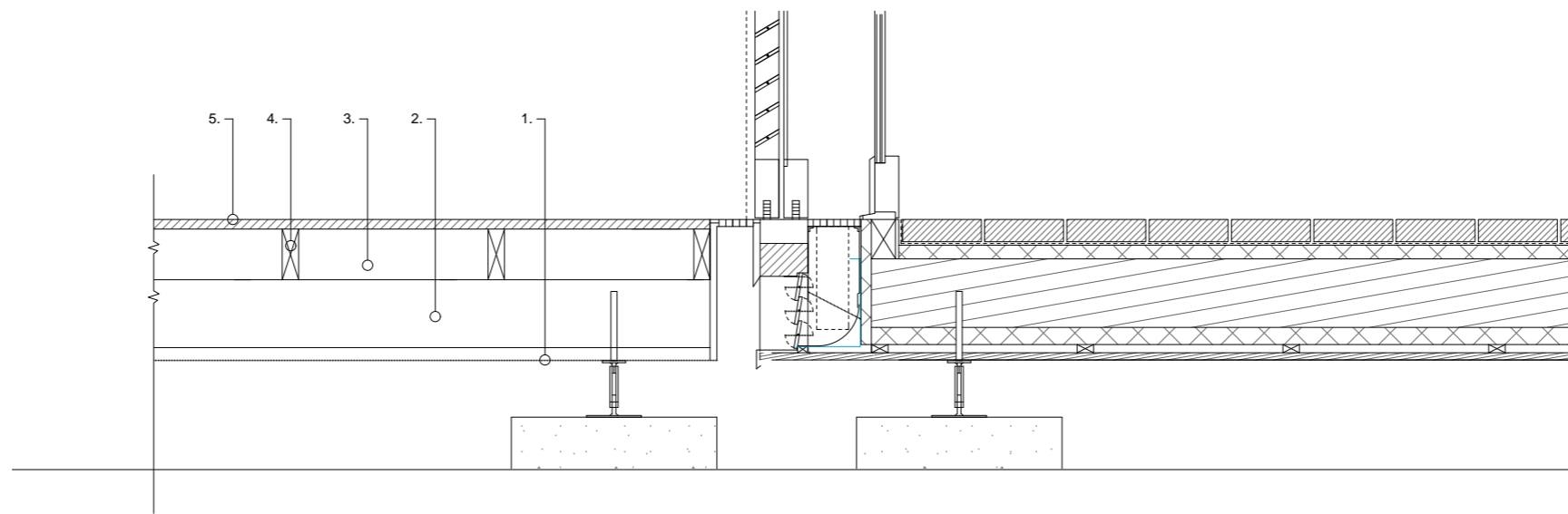

Will local Norwegian ground climate and conditions affect the foundations of the house?

Yes. The Norwegian ground freezes in winter and this can cause frost heave and sinking of soil (the frost causes forces that again causes movement in the ground). The house on lightweight pillars will therefore be a bad solution for Norwegian conditions.

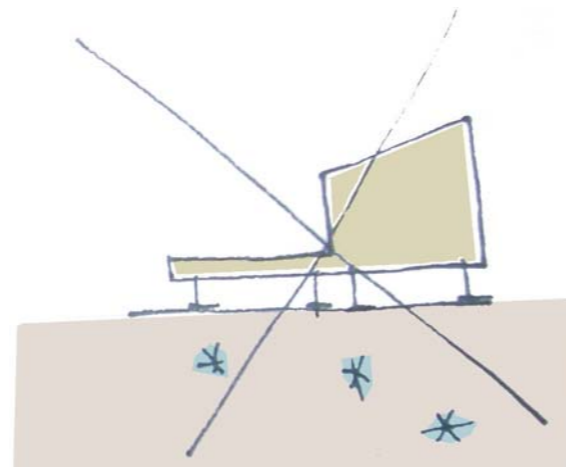

Madrid Style causes problems in Trondheim because of the Ground Frost..

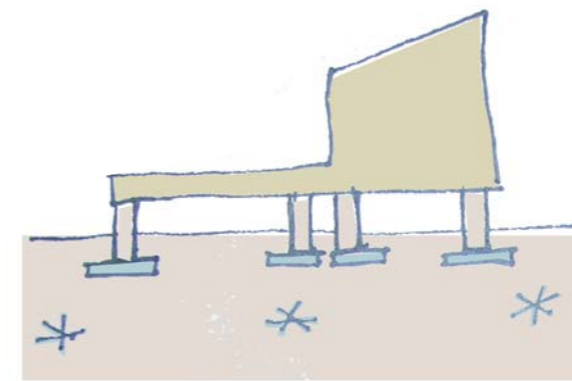

Norwegian Alternative 1:
Put the house on concrete posts with insolation underneath. The length of the foundations rely on local ground contitdons.

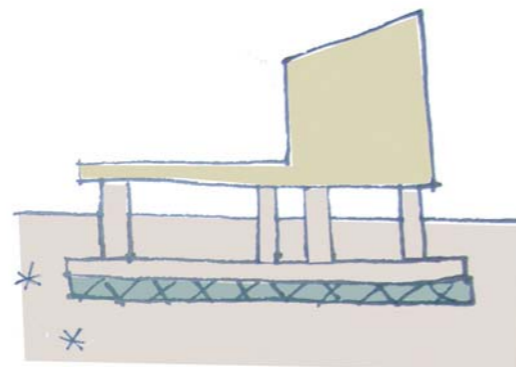

Norwegian Alternative 2:
To make a even better protection against frost problems the pilars can stand on a platform.

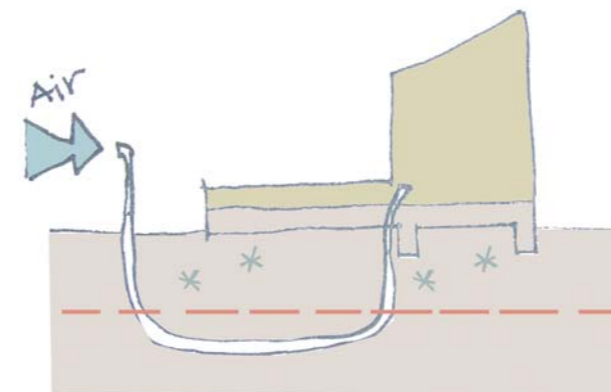

Norwegian Alternative 3:
Put the house on the ground and make a pipe for air inntake below frost level.

The Norwegian foundations alternative 1:20

1. Ground Frost safe and drainaging mass
2. Concrete Foudament
3. Isolation
4. Concrete platform (in case of need for better protection against frost probems)
5. Svillist
6. Fiber cloth
7. Earth

